

en

Earth Observation  
Mission CFI Software  
  
EO\_VISIBILITY  
SOFTWARE USER MANUAL

Code: EO-MA-DMS-GS-0006  
Issue: 4.8  
Date: 29/10/2014

|              | Name                          | Function         | Signature |
|--------------|-------------------------------|------------------|-----------|
| Prepared by: | José Antonio González Abeytua | Project Manager  |           |
|              | Juan José Borrego Bote        | Project Engineer |           |
|              | Carlos Villanueva Muñoz       | Project Engineer |           |
|              | Rubén Castro                  | Project Engineer |           |
| Checked by:  | José Antonio González Abeytua | Project Manager  |           |
| Approved by: | José Antonio González Abeytua | Project Manager  |           |

DEIMOS Space S.L.U  
Ronda de Poniente, 19  
Edificio Fiteni VI, Portal 2, 2ª Planta  
28760 Tres Cantos (Madrid), SPAIN  
Tel.: +34 91 806 34 50  
Fax: +34 91 806 34 51  
E-mail: deimos@deimos-space.com

© DEIMOS Space S.L.U

All Rights Reserved. No part of this document may be reproduced, stored in a retrieval system, or transmitted, in any form or by any means, electronic, mechanical, photocopying, recording or otherwise, without the prior written permission of DEIMOS Space S.L.U or ESA.

## DOCUMENT INFORMATION

| Contract Data    |                | Classification |   |
|------------------|----------------|----------------|---|
| Contract Number: | 15583/01/NL/GS | Internal       |   |
|                  |                | Public         |   |
| Contract Issuer: | ESA / ESTEC    | Industry       | X |
|                  |                | Confidential   |   |

| External Distribution |              |        |
|-----------------------|--------------|--------|
| Name                  | Organisation | Copies |
|                       |              |        |
|                       |              |        |
|                       |              |        |
|                       |              |        |
|                       |              |        |
|                       |              |        |
|                       |              |        |
|                       |              |        |
|                       |              |        |
|                       |              |        |

| Electronic handling   |                      |
|-----------------------|----------------------|
| Word Processor:       | LibreOffice 3.6      |
| Archive Code:         | P/SUM/DMS/01/026-029 |
| Electronic file name: | eo-ma-dms-gs-006-21  |

## DOCUMENT STATUS LOG

| Issue | Change Description   | Date     | Approval |
|-------|--|----------|----------|
| 1.0   | Unreleased   | 19/06/02 |          |
| 2.0   | Complete document  | 29/11/02 |          |
| 2.1   | Maintenance release with the following main changes: <ul style="list-style-type: none"> <li>• xv_multizones_vis_time added.</li> <li>• xv_multistation_vis_time added.</li> <li>• xv_time_segment_mapping added.</li> <li>• xv_orbit_extra added.</li> </ul>           | 13/05/03 |          |
| 2.2   | Maintenance release  | 30/09/03 |          |
| 2.2.2 | Small interface change in xv_time_segments_delta and xv_orbit_extra  | 26/04/04 |          |
| 3.0   | New initialisation strategy and interfaces.  | 21/07/04 |          |
| 3.1   | New features for xv_zone_vis_time function: <ul style="list-style-type: none"> <li>• Use of Predicted Orbit/Orbit event files.</li> <li>• Use of Swath Definition files.</li> </ul>  | 13/10/04 |          |
| 3.2   | Maintenance release  | 15/11/04 |          |
| 3.3   | New features: <ul style="list-style-type: none"> <li>• Use of Predicted Orbit/Orbit event files for all visibility functions.</li> <li>• Use of Swath Definition files for all visibility functions.</li> <li>• ENVISAT ASCII files are no longer supported</li> </ul> | 11/07/05 |          |
| 3.4   | <ul style="list-style-type: none"> <li>• Maintenance release.</li> <li>• gen_swath executable moved to this library.</li> <li>• Changes in the xv_swath_pos interface</li> </ul>   | 18/11/05 |          |
| 3.5   | Maintenance release.   | 26/05/06 |          |
| 3.6   | Maintenance release.   | 24/11/06 |          |

|       |   |          |  |
|-------|---|----------|--|
| 3.7   | <ul style="list-style-type: none"> <li>• Maintenance release.</li> <li>• New features:           <ul style="list-style-type: none"> <li>- xv_gen_scf</li> <li>- expcfi_check_libs</li> <li>- xv_zone_vis_time_no_file</li> <li>- xv_station_vis_time_no_file</li> <li>- xv_gen_swath_no_file</li> <li>- library version for Mac OS X on Intel (32 and 64 bits)</li> </ul> </li> </ul> | 13/07/07 |  |
| 3.7.2 | <ul style="list-style-type: none"> <li>• Maintenance release.</li> <li>• New features:           <ul style="list-style-type: none"> <li>- Curved and closed swaths for xv_zone_vis_time</li> </ul> </li> </ul>  | 31/07/08 |  |
| 4.0   | Maintenance release.  | 19/01/09 |  |
| 4.1   | <ul style="list-style-type: none"> <li>• Maintenance release</li> <li>• New features:           <ul style="list-style-type: none"> <li>- AOS/LOS mask mode from Ground Station DB 1.4 file</li> <li>- Visibility across orbital changes</li> </ul> </li> </ul>  | 07/05/10 |  |
| 4.2   | <ul style="list-style-type: none"> <li>• Maintenance release</li> <li>• New features:           <ul style="list-style-type: none"> <li>- Support of visibility functions with TLE and precise propagator</li> </ul> </li> </ul>   |          |  |
| 4.3   | <ul style="list-style-type: none"> <li>• Maintenance release</li> </ul>   |          |  |
| 4.4   | <ul style="list-style-type: none"> <li>• Maintenance release</li> <li>• New features:           <ul style="list-style-type: none"> <li>- Function xv_sc_vis_time</li> </ul> </li> </ul>   | 05/07/12 |  |
| 4.5   | <ul style="list-style-type: none"> <li>• Maintenance release</li> </ul>   | 01/03/13 |  |
| 4.6   | <ul style="list-style-type: none"> <li>• Maintenance release</li> <li>• New features:           <ul style="list-style-type: none"> <li>- Support for new swath ID.</li> <li>- New functions:               <ul style="list-style-type: none"> <li>xv_zonevistime_compute</li> <li>xv_stationvistime_compute</li> </ul> </li> </ul> </li> </ul>  | 03/10/13 |  |

|     |   |            |  |
|-----|---|------------|--|
|     | xv_swathpos_compute<br>xv_tiesegments_xxx_compute   |            |  |
| 4.7 | <ul style="list-style-type: none"> <li>• Maintenance release</li> <li>• New features:               <ul style="list-style-type: none"> <li>• New function xv_zonevistime_coverage</li> <li>• Support for satellites Jason-CS, MetOp-SG and Sentinel_5P</li> </ul> </li> </ul> | 28/03/2014 |  |
| 4.8 | <ul style="list-style-type: none"> <li>• Maintenance release</li> </ul>   | 29/10/2014 |  |

## TABLE OF CONTENTS

|   |    |
|---|----|
| DOCUMENT INFORMATION.....                     | 2  |
| DOCUMENT STATUS LOG.....                      | 3  |
| TABLE OF CONTENTS.....                        | 6  |
| LIST OF TABLES.....                           | 16 |
| LIST OF FIGURES.....                          | 19 |
| 1 SCOPE.....                                  | 20 |
| 2 ACRONYMS, NOMENCLATURE AND TERMINOLOGY..... | 21 |
| 2.1 Acronyms.....                             | 21 |
| 2.2 Nomenclature.....                         | 21 |
| 2.3 Note on Terminology.....                  | 22 |
| 3 APPLICABLE AND REFERENCE DOCUMENTS.....     | 23 |
| 3.1 Applicable Documents.....                 | 23 |
| 3.2 Reference Documents.....                  | 23 |
| 4 INTRODUCTION.....                           | 24 |
| 4.1 Functions Overview.....                   | 24 |
| 4.2 Calling Sequence.....                     | 26 |
| 5 LIBRARY INSTALLATION.....                   | 27 |
| 6 LIBRARY USAGE.....                          | 28 |
| 6.1 Usage hints.....                          | 30 |
| 6.2 General enumerations.....                 | 30 |
| 6.3 Data Structures.....                      | 32 |

---

|  |           |
|--|-----------|
| <b>7 CFI FUNCTIONS DESCRIPTION.....</b>                          | <b>49</b> |
| <b>7.1 xv_zone_vis_time.....</b>                                 | <b>50</b> |
| 7.1.1 Overview.....  | 50        |
| 7.1.2 Swath Definition.....                                      | 53        |
| 7.1.2.1 Earth-observing Instruments Swath Definition.....        | 53        |
| 7.1.2.2 Limb-sounding Instruments Swath Definition.....          | 54        |
| 7.1.2.3 Limb-sounding Instruments Inertial Swath Definition..... | 56        |
| 7.1.2.4 Swath Definition for Envisat.....                        | 56        |
| 7.1.3 Zone Borders and Projection.....                           | 59        |
| 7.1.4 Zone Definition.....                                       | 59        |
| 7.1.5 Intersection Definition.....                               | 61        |
| 7.1.6 Intersection Algorithm.....                                | 62        |
| 7.1.6.1 Intersection with a point swath.....                     | 62        |
| 7.1.6.2 Intersection with a segment swath.....                   | 62        |
| 7.1.6.3 Intersection with a multi-segment swath.....             | 63        |
| 7.1.7 Usage Hints.....   | 64        |
| 7.1.7.1 Limb-sounding Instruments Intersection.....              | 64        |
| 7.1.7.2 Zone Coverage.....                                       | 64        |
| 7.1.7.3 Combined use of xv_swath_pos and the coverage flag.....  | 65        |
| 7.1.8 Calling sequence.....                                      | 66        |
| 7.1.9 Input parameters.....                                      | 68        |
| 7.1.10 Output parameters.....                                    | 71        |
| 7.1.11 Warnings and errors.....                                  | 73        |
| <b>7.2 xv_zone_vis_time_no_file.....</b>                         | <b>78</b> |
| 7.2.1 Overview.....  | 78        |
| 7.2.2 Calling sequence.....                                      | 78        |
| 7.2.3 Input parameters.....                                      | 80        |
| 7.2.4 Output parameters.....                                     | 83        |
| 7.2.5 Warnings and errors.....                                   | 85        |
| <b>7.3 xv_zonevistime_compute.....</b>                           | <b>86</b> |
| 7.3.1 Overview.....  | 86        |
| 7.3.2 Swath Definition.....                                      | 89        |
| 7.3.2.1 Earth-observing Instruments Swath Definition.....        | 89        |

---

|  |            |
|--|------------|
| 7.3.2.2 Limb-sounding Instruments Swath Definition.....                | 90         |
| 7.3.2.3 Limb-sounding Instruments Inertial Swath Definition.....       | 92         |
| 7.3.2.4 Swath Definition for Envisat.....                              | 92         |
| 7.3.3 Zone Borders and Projection.....                                 | 94         |
| 7.3.4 Zone Definition.....   | 94         |
| 7.3.5 Intersection Definition.....                                     | 96         |
| 7.3.6 Intersection Algorithm.....                                      | 97         |
| 7.3.6.1 Intersection with a point swath.....                           | 97         |
| 7.3.6.2 Intersection with a segment swath.....                         | 97         |
| 7.3.6.3 Intersection with a multi-segment swath.....                   | 98         |
| 7.3.7 Usage Hints.....   | 99         |
| 7.3.7.1 Limb-sounding Instruments Intersection.....                    | 99         |
| 7.3.7.2 Zone Coverage.....   | 99         |
| 7.3.7.3 Combined use of xv_swathpos_compute and the coverage flag..... | 100        |
| 7.3.7.4 Use of input xp_attitude_def struct.....                       | 100        |
| 7.3.7.5 Use of input xv_zone_info_list struct.....                     | 100        |
| 7.3.8 Calling sequence.....  | 101        |
| 7.3.9 Input parameters.....  | 102        |
| 7.3.10 Output parameters.....  | 103        |
| 7.3.11 Warnings and errors.....  | 104        |
| <b>7.4 xv_station_vis_time.....</b>                                    | <b>107</b> |
| 7.4.1 Overview.....  | 107        |
| 7.4.2 Calling interface.....   | 109        |
| 7.4.3 Input parameters.....  | 111        |
| 7.4.4 Output parameters.....   | 114        |
| 7.4.5 Warnings and errors.....   | 116        |
| <b>7.5 xv_station_vis_time_no_file.....</b>                            | <b>119</b> |
| 7.5.1 Overview.....  | 119        |
| 7.5.2 Calling interface.....   | 119        |
| 7.5.3 Input parameters.....  | 121        |
| 7.5.4 Output parameters.....   | 124        |
| 7.5.5 Warnings and errors.....   | 126        |
| <b>7.6 xv_stationvistime_compute.....</b>                              | <b>127</b> |



---

|  |            |
|--|------------|
| 7.6.1 Overview.....  | 127        |
| 7.6.2 Usage Hints.....   | 128        |
| 7.6.2.1 Use of input xp_attitude_def struct.....                             | 128        |
| 7.6.2.2 Use of input xv_station_info_list struct.....                        | 128        |
| min_duration: indicates the minimum duration for the segments (seconds)..... | 129        |
| 7.6.3 Calling interface.....   | 130        |
| 7.6.4 Input parameters.....  | 131        |
| 7.6.5 Output parameters.....   | 132        |
| 7.6.6 Warnings and errors.....   | 133        |
| <b>7.7 xv_sc_vis_time.....</b>   | <b>136</b> |
| 7.7.1 Overview.....  | 136        |
| 7.7.2 Calling interface.....   | 137        |
| 7.7.3 Input parameters.....  | 140        |
| 7.7.4 Output parameters.....   | 142        |
| 7.7.5 Warnings and errors.....   | 144        |
| <b>7.8 xv_swath_pos.....</b>   | <b>145</b> |
| 7.8.1 Overview.....  | 145        |
| 7.8.2 Calling sequence of xv_swath_pos.....                                  | 147        |
| 7.8.3 Input parameters xv_swath_pos.....                                     | 148        |
| 7.8.4 Output parameters xv_swath_pos.....                                    | 148        |
| 7.8.5 Warnings and errors.....   | 150        |
| <b>7.9 xv_swathpos_compute.....</b>  | <b>152</b> |
| 7.9.1 Overview.....  | 152        |
| 7.9.2 Calling sequence of xv_swathpos_compute.....                           | 153        |
| 7.9.3 Input parameters xv_swathpos_compute.....                              | 154        |
| 7.9.4 Output parameters xv_swathpos_compute.....                             | 154        |
| 7.9.5 Warnings and errors.....   | 155        |
| <b>7.10 xv_star_vis_time.....</b>  | <b>157</b> |
| 7.10.1 Overview.....   | 157        |
| 7.10.2 Swath Definition.....   | 159        |
| 7.10.2.1 Inertial Swaths.....  | 159        |
| 7.10.2.2 Splitting swaths.....   | 160        |

---

---

|   |            |
|---|------------|
| 7.10.2.3 Orbital Changes.....                           | 160        |
| 7.10.2.4 Format of Swath Template File.....             | 161        |
| 7.10.2.5 MLST non linear drift.....                     | 161        |
| 7.10.3 Calling sequence xv_star_vis_time.....           | 162        |
| 7.10.4 Input parameters xv_star_vis_time.....           | 164        |
| 7.10.5 Output parameters xv_star_vis_time.....          | 166        |
| 7.10.6 Warnings and errors.....                         | 168        |
| <b>7.11 xv_multizones_vis_time.....</b>                 | <b>171</b> |
| 7.11.1 Overview.....                                    | 171        |
| 7.11.2 Calling sequence xv_multizones_vis_time.....     | 174        |
| 7.11.3 Input parameters xv_multizones_vis_time.....     | 176        |
| 7.11.4 Output parameters xv_multizones_vis_time.....    | 179        |
| 7.11.5 Warnings and errors.....                         | 181        |
| <b>7.12 xv_multistations_vis_time.....</b>              | <b>182</b> |
| 7.12.1 Overview.....                                    | 182        |
| 7.12.2 Calling sequence xv_multistations_vis_time.....  | 184        |
| 7.12.3 Input parameters xv_multistations_vis_time.....  | 186        |
| 7.12.4 Output parameters xv_multistations_vis_time..... | 188        |
| 7.12.5 Warnings and errors.....                         | 190        |
| <b>7.13 xv_orbit_extra.....</b>                         | <b>191</b> |
| 7.13.1 Overview.....                                    | 191        |
| 7.13.2 Calling sequence xv_orbit_extra.....             | 192        |
| 7.13.3 Input parameters xv_orbit_extra.....             | 193        |
| 7.13.4 Output parameters xv_orbit_extra.....            | 194        |
| 7.13.5 Warnings and errors.....                         | 196        |
| <b>7.14 xv_gps_vis_time.....</b>                        | <b>197</b> |
| <b>7.15 xv_time_segments_not.....</b>                   | <b>198</b> |
| 7.15.1 Overview.....                                    | 198        |
| 7.15.2 Calling sequence xv_time_segments_not.....       | 199        |
| 7.15.3 Input parameters xv_time_segments_not.....       | 201        |
| 7.15.4 Output parameters xv_time_segments_not.....      | 202        |
| 7.15.5 Warnings and errors.....                         | 203        |

---

---

|   |            |
|---|------------|
| <b>7.16 xv_timesegments_compute_not.....</b>              | <b>204</b> |
| 7.16.1 Overview.....                                      | 204        |
| 7.16.2 Calling sequence xv_timesegments_compute_not.....  | 205        |
| 7.16.3 Input parameters xv_timesegments_compute_not.....  | 206        |
| 7.16.4 Output parameters xv_timesegments_compute_not..... | 207        |
| 7.16.5 Warnings and errors.....                           | 208        |
| <b>7.17 xv_time_segments_or.....</b>                      | <b>209</b> |
| 7.17.1 Overview.....                                      | 209        |
| 7.17.2 Calling sequence xv_time_segments_or.....          | 210        |
| 7.17.3 Input parameters xv_time_segments_or.....          | 212        |
| 7.17.4 Output parameters xv_time_segments_or.....         | 214        |
| 7.17.5 Warnings and errors.....                           | 215        |
| <b>7.18 xv_timesegments_compute_or.....</b>               | <b>216</b> |
| 7.18.1 Overview.....                                      | 216        |
| 7.18.2 Calling sequence xv_timesegments_compute_or.....   | 217        |
| 7.18.3 Input parameters xv_timesegments_compute_or.....   | 218        |
| 7.18.4 Output parameters xv_timesegments_compute_or.....  | 219        |
| 7.18.5 Warnings and errors.....                           | 220        |
| <b>7.19 xv_time_segments_and.....</b>                     | <b>221</b> |
| 7.19.1 Overview.....                                      | 221        |
| 7.19.2 Calling sequence xv_time_segments_and.....         | 222        |
| 7.19.3 Input parameters xv_time_segments_and.....         | 224        |
| 7.19.4 Output parameters xv_time_segments_and.....        | 226        |
| 7.19.5 Warnings and errors.....                           | 227        |
| <b>7.20 xv_timesegments_compute_and.....</b>              | <b>228</b> |
| 7.20.1 Overview.....                                      | 228        |
| 7.20.2 Calling sequence xv_timesegments_compute_and.....  | 229        |
| 7.20.3 Input parameters xv_timesegments_compute_and.....  | 230        |
| 7.20.4 Output parameters xv_timesegments_compute_and..... | 231        |
| 7.20.5 Warnings and errors.....                           | 232        |
| <b>7.21 xv_time_segments_sort.....</b>                    | <b>233</b> |
| 7.21.1 Overview.....                                      | 233        |

---

---

|   |            |
|---|------------|
| 7.21.2 Calling sequence xv_time_segments_sort.....          | 234        |
| 7.21.3 Input parameters xv_time_segments_sort.....          | 235        |
| 7.21.4 Output parameters xv_time_segments_sort.....         | 236        |
| 7.21.5 Warnings and errors.....                             | 237        |
| <b>7.22 xv_timesegments_compute_sort.....</b>               | <b>238</b> |
| 7.22.1 Overview.....  | 238        |
| 7.22.2 Calling sequence xv_timesegments_compute_sort.....   | 239        |
| 7.22.3 Input parameters xv_timesegments_compute_sort.....   | 240        |
| 7.22.4 Output parameters xv_timesegments_compute_sort.....  | 241        |
| 7.22.5 Warnings and errors.....                             | 242        |
| <b>7.23 xv_time_segments_merge.....</b>                     | <b>243</b> |
| 7.23.1 Overview.....  | 243        |
| 7.23.2 Calling sequence xv_time_segments_merge.....         | 244        |
| 7.23.3 Input parameters xv_time_segments_merge.....         | 246        |
| 7.23.4 Output parameters xv_time_segments_merge.....        | 247        |
| 7.23.5 Warnings and errors.....                             | 248        |
| <b>7.24 xv_timesegments_compute_merge.....</b>              | <b>249</b> |
| 7.24.1 Overview.....  | 249        |
| 7.24.2 Calling sequence xv_timesegments_compute_merge.....  | 250        |
| 7.24.3 Input parameters xv_timesegments_compute_merge.....  | 251        |
| 7.24.4 Output parameters xv_timesegments_compute_merge..... | 252        |
| 7.24.5 Warnings and errors.....                             | 253        |
| <b>7.25 xv_time_segments_delta.....</b>                     | <b>254</b> |
| 7.25.1 Overview.....  | 254        |
| 7.25.2 Calling sequence xv_time_segments_delta.....         | 255        |
| 7.25.3 Input parameters xv_time_segments_delta.....         | 257        |
| 7.25.4 Output parameters xv_time_segments_delta.....        | 258        |
| 7.25.5 Warnings and errors.....                             | 259        |
| <b>7.26 xv_timesegments_compute_delta.....</b>              | <b>260</b> |
| 7.26.1 Overview.....  | 260        |
| 7.26.2 Calling sequence xv_timesegments_compute_delta.....  | 261        |
| 7.26.3 Input parameters xv_timesegments_compute_delta.....  | 262        |

---

---

|   |            |
|---|------------|
| 7.26.4 Output parameters xv_timesegments_compute_delta.....   | 262        |
| 7.26.5 Warnings and errors.....                               | 263        |
| <b>7.27 xv_time_segments_mapping.....</b>                     | <b>265</b> |
| 7.27.1 Overview.....  | 265        |
| 7.27.2 Calling sequence xv_time_segments_mapping.....         | 267        |
| 7.27.3 Input parameters xv_time_segments_mapping.....         | 269        |
| 7.27.4 Output parameters xv_time_segments_mapping.....        | 272        |
| 7.27.5 Warnings and errors.....                               | 274        |
| <b>7.28 xv_timesegments_compute_mapping.....</b>              | <b>276</b> |
| 7.28.1 Overview.....  | 276        |
| 7.28.2 Calling sequence xv_timesegments_compute_mapping.....  | 278        |
| 7.28.3 Input parameters xv_timesegments_compute_mapping.....  | 279        |
| 7.28.4 Output parameters xv_timesegments_compute_mapping..... | 280        |
| 7.28.5 Warnings and errors.....                               | 281        |
| <b>7.29 xv_gen_swath.....</b>                                 | <b>284</b> |
| 7.29.1 Overview.....  | 284        |
| 7.29.2 Calling interface.....                                 | 285        |
| 7.29.3 Input parameters.....                                  | 286        |
| 7.29.4 Output parameters.....                                 | 287        |
| 7.29.5 Warnings and errors.....                               | 288        |
| 7.29.6 Executable Program.....                                | 289        |
| <b>7.30 xv_gen_swath_no_file.....</b>                         | <b>291</b> |
| 7.30.1 Overview.....  | 291        |
| 7.30.2 Calling interface.....                                 | 291        |
| 7.30.3 Input parameters.....                                  | 292        |
| 7.30.4 Output parameters.....                                 | 292        |
| 7.30.5 Warnings and errors.....                               | 293        |
| <b>7.31 xv_gen_scf.....</b>                                   | <b>294</b> |
| 7.31.1 Overview.....  | 294        |
| 7.31.2 Calling interface.....                                 | 294        |
| 7.31.3 Input parameters.....                                  | 295        |
| 7.31.4 Output parameters.....                                 | 296        |

---

|   |            |
|---|------------|
| 7.31.5 Warnings and errors.....                         | 297        |
| <b>7.32 xv_swath_id_init.....</b>                       | <b>298</b> |
| 7.32.1 Overview.....                                    | 298        |
| 7.32.2 Calling sequence of xv_swath_id_init.....        | 299        |
| 7.32.3 Input parameters xv_swath_id_init.....           | 300        |
| 7.32.4 Output parameters xv_swath_id_init.....          | 300        |
| 7.32.5 Warnings and errors.....                         | 301        |
| <b>7.33 xv_swath_id_close.....</b>                      | <b>302</b> |
| 7.33.1 Overview.....                                    | 302        |
| 7.33.2 Calling sequence of xv_swath_id_close.....       | 303        |
| 7.33.3 Input parameters xv_swath_id_close.....          | 304        |
| 7.33.4 Output parameters xv_swath_id_close.....         | 304        |
| 7.33.5 Warnings and errors.....                         | 305        |
| <b>7.34 xv_swath_set_id_data.....</b>                   | <b>306</b> |
| 7.34.1 Overview.....                                    | 306        |
| 7.34.2 Calling sequence of xv_swath_set_id_data.....    | 307        |
| 7.34.3 Input parameters xv_swath_set_id_data.....       | 308        |
| 7.34.4 Output parameters xv_swath_set_id_data.....      | 308        |
| 7.34.5 Warnings and errors.....                         | 309        |
| <b>7.35 xv_swath_get_id_data.....</b>                   | <b>310</b> |
| 7.35.1 Overview.....                                    | 310        |
| 7.35.2 Calling sequence of xv_swath_get_id_data.....    | 311        |
| 7.35.3 Input parameters xv_swath_get_id_data.....       | 312        |
| 7.35.4 Output parameters xv_swath_get_id_data.....      | 312        |
| 7.35.5 Warnings and errors.....                         | 313        |
| <b>7.36 xv_zonevistime_coverage.....</b>                | <b>314</b> |
| 7.36.1 Overview.....                                    | 314        |
| 7.36.2 Calling sequence of xv_zonevistime_coverage..... | 318        |
| 7.36.3 Input parameters xv_zonevistime_coverage.....    | 319        |
| 7.36.4 Output parameters xv_zonevistime_coverage.....   | 319        |
| 7.36.5 Warnings and errors.....                         | 320        |

---

**8 RUNTIME PERFORMANCES..... 321**

**9 KNOWN PROBLEMS..... 323**

## LIST OF TABLES

|  |     |
|--|-----|
| Table 1: Correspondence of current functions and deprecated functions..... | 25  |
| Table 2: CFI functions included within EO_VISIBILITY library.....          | 29  |
| Table 3: Some enumerations within EO_VISIBILITY library.....               | 31  |
| Table 4: EO_VISIBILITY structures.....                                     | 33  |
| Table 5: Envisat Swaths.....   | 56  |
| Table 6: Zone definition.....  | 59  |
| Table 7: Input parameters of xv_zone_vis_time function.....                | 68  |
| Table 8: Output parameters of xv_zone_vis_time function.....               | 71  |
| Table 9: Error messages and codes for xv_zone_vis_time.....                | 73  |
| Table 10: Input parameters of xv_zone_vis_time_no_file function.....       | 80  |
| Table 11: Output parameters of xv_zone_vis_time_no_file function.....      | 83  |
| Table 12: Envisat Swaths.....  | 92  |
| Table 13: Zone definition (for xd_zone_rec).....                           | 94  |
| Table 14: Input parameters of xv_zonevistime_compute function.....         | 102 |
| Table 15: Output parameters of xv_zonevistime_compute function.....        | 103 |
| Table 16: Error messages and codes for xv_zonevistime_compute.....         | 104 |
| Table 17: Input parameters of xv_station_vis_time.....                     | 111 |
| Table 18: Output parameters of xv_station_vis_time function.....           | 114 |
| Table 19: Error messages and codes for xv_station_vis_time.....            | 116 |
| Table 20: Input parameters of xv_station_vis_time_no_file.....             | 121 |
| Table 21: Output parameters of xv_station_vis_time_no_file function.....   | 124 |
| Table 22: Input parameters of xv_stationvistime_compute.....               | 131 |
| Table 23: Output parameters of xv_stationvistime_compute function.....     | 132 |
| Table 24: Error messages and codes for xv_stationvistime_compute.....      | 133 |
| Table 25: Input parameters of xv_sc_vis_time.....                          | 140 |
| Table 26: Output parameters of xv_sc_vis_time function.....                | 142 |
| Table 27: Error messages of xv_sc_vis_time.....                            | 144 |
| Table 28: Input parameters of xv_swath_pos.....                            | 148 |
| Table 29: Output parameters of xv_swath_pos.....                           | 148 |
| Table 30: Error messages and codes.....                                    | 150 |
| Table 31: Input parameters of xv_swathpos_compute.....                     | 154 |
| Table 32: Output parameters of xv_swathpos_compute.....                    | 154 |
| Table 33: Error messages and codes.....                                    | 155 |
| Table 34: Input parameters of xv_star_vis_time.....                        | 164 |
| Table 35: Output Parameters of xv_star_vis_time.....                       | 166 |
| Table 36: Error messages and codes.....                                    | 168 |
| Table 37: Input parameters of xv_multizones_vis_time.....                  | 176 |
| Table 38: Output parameters of xv_multizones_vis_time.....                 | 179 |
| Table 39: Error messages and codes.....                                    | 181 |
| Table 40: Input parameters of xv_multistations_vis_time.....               | 186 |
| Table 41: Output parameters of xv_multistations_vis_time.....              | 188 |
| Table 42: Error messages and codes.....                                    | 190 |
| Table 43: Input parameters of xv_orbit_extra.....                          | 193 |
| Table 44: Output parameters of xv_orbi_extra.....                          | 194 |
| Table 45: Error messages and codes.....                                    | 196 |
| Table 46: Input parameters of xv_time_segments_not.....                    | 201 |



|   |     |
|---|-----|
| Table 47: Output parameters of xv_time_segments_not.....            | 202 |
| Table 48: Error messages and codes.....                             | 203 |
| Table 49: Input parameters of xv_timesegments_compute_not.....      | 206 |
| Table 50: Output parameters of xv_timesegments_compute_not.....     | 207 |
| Table 51: Error messages and codes.....                             | 208 |
| Table 52: Input parameters of xv_time_segments_or.....              | 212 |
| Table 53: Output parameters of xv_time_segments_or.....             | 214 |
| Table 54: Error messages and codes.....                             | 215 |
| Table 55: Input parameters of xv_timesegments_compute_or.....       | 218 |
| Table 56: Output parameters of xv_timesegments_compute_or.....      | 219 |
| Table 57: Error messages and codes.....                             | 220 |
| Table 58: Input parameters of xv_time_segments_and.....             | 224 |
| Table 59: Output parameters of xv_time_segments_and.....            | 226 |
| Table 60: Error messages and codes.....                             | 227 |
| Table 61: Input parameters of xv_timesegments_compute_and.....      | 230 |
| Table 62: Output parameters of xv_timesegments_compute_and.....     | 231 |
| Table 63: Error messages and codes.....                             | 232 |
| Table 64: xv_time_segments_sort function.....                       | 233 |
| Table 65: Input parameters of xv_time_segments_sort.....            | 235 |
| Table 66: Output parameters of xv_time_segments_sort.....           | 236 |
| Table 67: Error messages and codes.....                             | 237 |
| Table 68: xv_timesegments_compute_sort function.....                | 238 |
| Table 69: Input parameters of xv_timesegments_compute_sort.....     | 240 |
| Table 70: Output parameters of xv_timesegments_compute_sort.....    | 241 |
| Table 71: Error messages and codes.....                             | 242 |
| Table 72: Input parameters of xv_time_segments_merge.....           | 246 |
| Table 73: Output parameters of xv_time_segments_merge.....          | 247 |
| Table 74: Error messages and codes.....                             | 248 |
| Table 75: Input parameters of xv_timesegments_compute_merge.....    | 251 |
| Table 76: Output parameters of xv_timesegments_compute_merge.....   | 252 |
| Table 77: Error messages and codes.....                             | 253 |
| Table 78: Input parameters of xv_time_segments_delta.....           | 257 |
| Table 79: Output parameters of xv_time_segments_delta.....          | 258 |
| Table 80: Error messages and codes.....                             | 259 |
| Table 81: Input parameters of xv_timesegments_compute_delta.....    | 262 |
| Table 82: Output parameters of xv_timesegments_compute_delta.....   | 262 |
| Table 83: Error messages and codes.....                             | 263 |
| Table 84: Input parameters of xv_time_segments_mapping.....         | 269 |
| Table 85: Output parameters of xv_time_segments_mapping.....        | 272 |
| Table 86: Error messages and codes.....                             | 274 |
| Table 87: Input parameters of xv_timesegments_compute_mapping.....  | 279 |
| Table 88: Output parameters of xv_timesegments_compute_mapping..... | 280 |
| Table 89: Error messages and codes.....                             | 281 |
| Table 90: Swath geometry definition (algorithm).....                | 284 |
| Table 91: Input parameters of xv_gen_swath function.....            | 286 |
| Table 92: Output parameters of xv_gen_swath function.....           | 287 |
| Table 93: Error messages of xv_gen_swath function.....              | 288 |
| Table 94: Input parameters of xv_gen_swath_no_file function.....    | 292 |
| Table 95: Output parameters of xv_gen_swath_no_file function.....   | 292 |

---

|  |     |
|--|-----|
| Table 96: Input parameters of xv_gen_scf function.....       | 295 |
| Table 97: Output parameters of xv_gen_scf function.....      | 296 |
| Table 98: Error messages of xv_gen_scf function.....         | 297 |
| Table 99: Input parameters of xv_swath_id_init.....          | 300 |
| Table 100: Output parameters of xv_swath_id_init.....        | 300 |
| Table 101: Error messages and codes.....                     | 301 |
| Table 102: Input parameters of xv_swath_id_close.....        | 304 |
| Table 103: Output parameters of xv_swath_id_close.....       | 304 |
| Table 104: Error messages and codes.....                     | 305 |
| Table 105: Input parameters of xv_swath_set_id_data.....     | 308 |
| Table 106: Output parameters of xv_swath_set_id_data.....    | 308 |
| Table 107: Input parameters of xv_swath_get_id_data.....     | 312 |
| Table 108: Output parameters of xv_swath_get_id_data.....    | 312 |
| Table 109: Input parameters of xv_zonevistime_coverage.....  | 319 |
| Table 110: Output parameters of xv_zonevistime_coverage..... | 319 |
| Table 111: Error messages and codes.....                     | 320 |
| Table 112: Known problems.....                               | 323 |

## LIST OF FIGURES

|  |     |
|--|-----|
| Figure 1: EO_VISIBILITY Data Flow.....                               | 26  |
| Figure 2: Segment Definition xv_zone_vis_time.....                   | 50  |
| Figure 3: Earth-observing instrument: swath definition.....          | 54  |
| Figure 4: Limb-sounding instrument: swath definition (1).....        | 55  |
| Figure 5: Limb-sounding instrument: swath definition (2).....        | 55  |
| Figure 6: Zone examples.....   | 60  |
| Figure 7: Intersection examples.....                                 | 61  |
| Figure 8: Swath points.....  | 63  |
| Figure 9: Swath coverage definition.....                             | 64  |
| Figure 10: Segment Definition xv_zonevistime_compute.....            | 86  |
| Figure 11: xv_zonevistime_compute function (more than one zone)..... | 87  |
| Figure 12: Earth-observing instrument: swath definition.....         | 90  |
| Figure 13: Limb-sounding instrument: swath definition (1).....       | 91  |
| Figure 14: Limb-sounding instrument: swath definition (2).....       | 91  |
| Figure 15: Zone examples.....  | 95  |
| Figure 16: Intersection examples.....                                | 96  |
| Figure 17: Swath points.....   | 98  |
| Figure 18: Swath coverage definition.....                            | 99  |
| Figure 19: Two tangent altitudes over the ellipsoid.....             | 159 |
| Figure 20: Instantaneous FOV projected on the celestial sphere.....  | 160 |
| Figure 21: xv_multizones_vis_time function.....                      | 172 |
| Figure 22: xv_time_segment_not_function.....                         | 198 |
| Figure 23: xv_timesegments_compute_not function.....                 | 204 |
| Figure 24: xv_time_segments_or_function.....                         | 209 |
| Figure 25: xv_timesegments_compute_or_function.....                  | 216 |
| Figure 26: xv_time_segments_and_function.....                        | 221 |
| Figure 27: xv_timesegments_compute_and_function.....                 | 228 |
| Figure 28: xv_time_segments_merge function.....                      | 243 |
| Figure 29: xv_timesegments_compute_merge function.....               | 249 |
| Figure 30: Different mappings with common segments.....              | 265 |
| Figure 31: Different mappings with common segments.....              | 276 |

## 1 SCOPE

The EO\_VISIBILITY Software User Manual provides a detailed description of usage of the CFI functions included within the EO\_VISIBILITY CFI software library.

## 2 ACRONYMS, NOMENCLATURE AND TERMINOLOGY

### 2.1 Acronyms

|         |   |
|---------|---|
| ANX     | Ascending Node Crossing                       |
| AOCS    | Attitude and Orbit Control Subsystem          |
| CFI     | Customer Furnished Item                       |
| EF      | Earth Fixed reference frame                   |
| ESA     | European Space Agency                         |
| ESTEC   | European Space Technology and Research Centre |
| FOS     | Flight Operations Segment                     |
| GS      | Ground Station                                |
| OSF     | Orbit Scenario File                           |
| SCF     | Swath Control File                            |
| SDF     | Swath Definition File                         |
| SRAR    | Satellite Relative Actual Reference           |
| SSP     | Sub-Satellite Point                           |
| STF     | Swath Template File                           |
| SUM     | Software User Manual                          |
| TOD     | True of Date reference frame                  |
| UTC     | Universal Time Coordinated                    |
| UT1     | Universal Time UT1                            |
| WGS[84] | World Geodetic System 1984                    |

### 2.2 Nomenclature

|                     |   |
|---------------------|---|
| <i>CFI</i>          | A group of CFI functions, and related software and documentation that will be distributed by ESA to the users as an independent unit                            |
| <i>CFI function</i> | A single function within a CFI that can be called by the user   |
| <i>Library</i>      | A software library containing all the CFI functions included within a CFI plus the supporting functions used by those CFI functions (transparently to the user) |

## 2.3 Note on Terminology

In order to keep compatibility with legacy CFI libraries, the Earth Observation Mission CFI Software makes use of terms that are linked with missions already or soon in the operational phase like the Earth Explorers.

This may be reflected in the rest of the document when examples of Mission CFI Software usage are proposed or description of Mission Files is given.

## 3 APPLICABLE AND REFERENCE DOCUMENTS

### 3.1 Applicable Documents

No applicable documents.

### 3.2 Reference Documents

|             |   |
|-------------|---|
| [GEN_SUM]   | Earth Observation Mission CFI Software. General Software User Manual. EO-MA-DMS-GS-0002.          |
| [F_H_SUM]   | Earth Observation Mission CFI Software. EO_FILE_HANDLING Software User Manual. EO-MA-DMS-GS-0008. |
| [D_H_SUM]   | Earth Observation Mission CFI Software. EO_DATA_HANDLING Software User Manual. EO-MA-DMS-GS-0007. |
| [LIB_SUM]   | Earth Observation Mission CFI Software. EO_LIB Software User Manual. EO-MA-DMS-GS-0003.           |
| [ORBIT_SUM] | Earth Observation Mission CFI Software. EO_ORBIT Software User Manual. EO-MA-DMS-GS-0004.         |
| [POINT_SUM] | Earth Observation Mission CFI Software. EO_POINTING Software User Manual. EO-MA-DMS-GS-0005.      |
| [FORMATS]   | Earth Explorer File Format Guidelines. CS-TN-ESA-GS-0148.   |

## 4 INTRODUCTION

### 4.1 Functions Overview

This software library contains the CFI functions required to compute time segments at which an Earth Observation satellite, or one of its instruments is in view of various targets:

- zones (defined as polygons or circles, on the earth ellipsoid or at a given altitude)
- ground stations
- data relay satellites
- stars

This library is to be used for planning of Earth Observation operations. It includes, the following CFI functions:

- **xv\_stationvistime\_compute**: compute visibility time segments for one or several ground stations.
- **xv\_sc\_vis\_time**: computes visibility time segments for a target satellite
- **xv\_zonevistime\_compute**: compute visibility time segments for an instrument swath in visibility of one or several zones.
- **xv\_swathpos\_compute**: computes location of a swath at a given time (additional routine to help refine the results of **xv\_zonevistime\_compute**)
- **xv\_star\_vis\_time**: computes visibility time segments for a star.
- **xv\_gps\_vis\_time**: computes visibility time segments for a gps constellation.
- **xv\_gen\_swath** and **xv\_gen\_swath\_no\_file** generate the instrument swath template file for a given satellite, instrument mode and orbit.
- **xv\_gen\_scf** generates a swath control file for the ESOV tool.
- Time Segments Manipulation Routines:
  - **xv\_timesegments\_compute\_not**: returns the complement of 1 vector of time segments.
  - **xv\_timesegments\_compute\_and**: returns the intersection segments from 2 vectors of time segments.
  - **xv\_timesegments\_compute\_or**: returns the joined segments from 2 vectors of time segments
  - **xv\_timesegments\_compute\_delta**: add or subtract time durations at the beginning and end of each time segment in a vector.
  - **xv\_timesegments\_compute\_sort**: returns the vector of time segments sorted according to absolute or relative orbits.
  - **xv\_timesegments\_compute\_merge**: merges all the overlapped segments in a list.
  - **xv\_timesegments\_compute\_mapping**: returns a subset of the time segments vector, such that this subset covers entirely a zone or line swath.

Several files are required to operate properly the above functions:

- Orbit Scenario File (all functions)
- Swath Template Files (**xv\_stationvistime\_compute**, **xv\_zonevistime\_compute**, **xv\_swathpos\_compute**)
- Ground Stations Database File (**xv\_stationvistime\_compute**)
- (optionally) Zones Database File (**xv\_zonevistime\_compute**)
- (optionally) Star Database File (**xv\_star\_vis\_time**)



Note that all the above routines use orbit-relative time parameters (i.e. the time parameters are represented as orbit number + time since ascending node). Two functions from EO\_ORBIT will be very useful to process the input/outputs:

- **xo\_time\_to\_orbit**: converts from TAI/UTC/UT1 time to orbit-relative time
- **xo\_orbit\_to\_time**: converts from orbit-relative time to TAI/UTC/UT1 time

Since version of EO\_CFI 4.6, some of the visibility functions have been substituted by newer functions, which have an equivalent functionality. The older versions have been declared deprecated, although they can still be used; anyway, it is recommended to use the new functions. In the table 1 you can find the correspondence between the old (deprecated) functions and the new ones which have an equivalent functionality.

**Table 1: Correspondence of current functions and deprecated functions**

| Current function                | Corresponding deprecated function(s)  |
|---------------------------------|---|
| xv_stationvistime_compute       | xv_station_vis_time<br>xv_station_vis_time_no_file<br>xv_multistations_vis_time |
| xv_swathpos_compute             | xv_swath_pos  |
| xv_timesegments_compute_and     | xv_time_segments_and  |
| xv_timesegments_compute_or      | xv_time_segments_delta  |
| xv_timesegments_compute_not     | xv_time_segments_mapping  |
| xv_timesegments_compute_sort    | xv_time_segments_merge  |
| xv_timesegments_compute_merge   | xv_time_segments_not  |
| xv_timesegments_compute_delta   | xv_time_segments_or   |
| xv_timesegments_compute_mapping | xv_time_segments_sort   |
| xv_zonevistime_compute          | xv_zone_vis_time<br>xv_zone_vis_time_no_file<br>xv_multizones_vis_time          |

## 4.2 Calling Sequence

An overview of the data flow is presented in Figure 1,

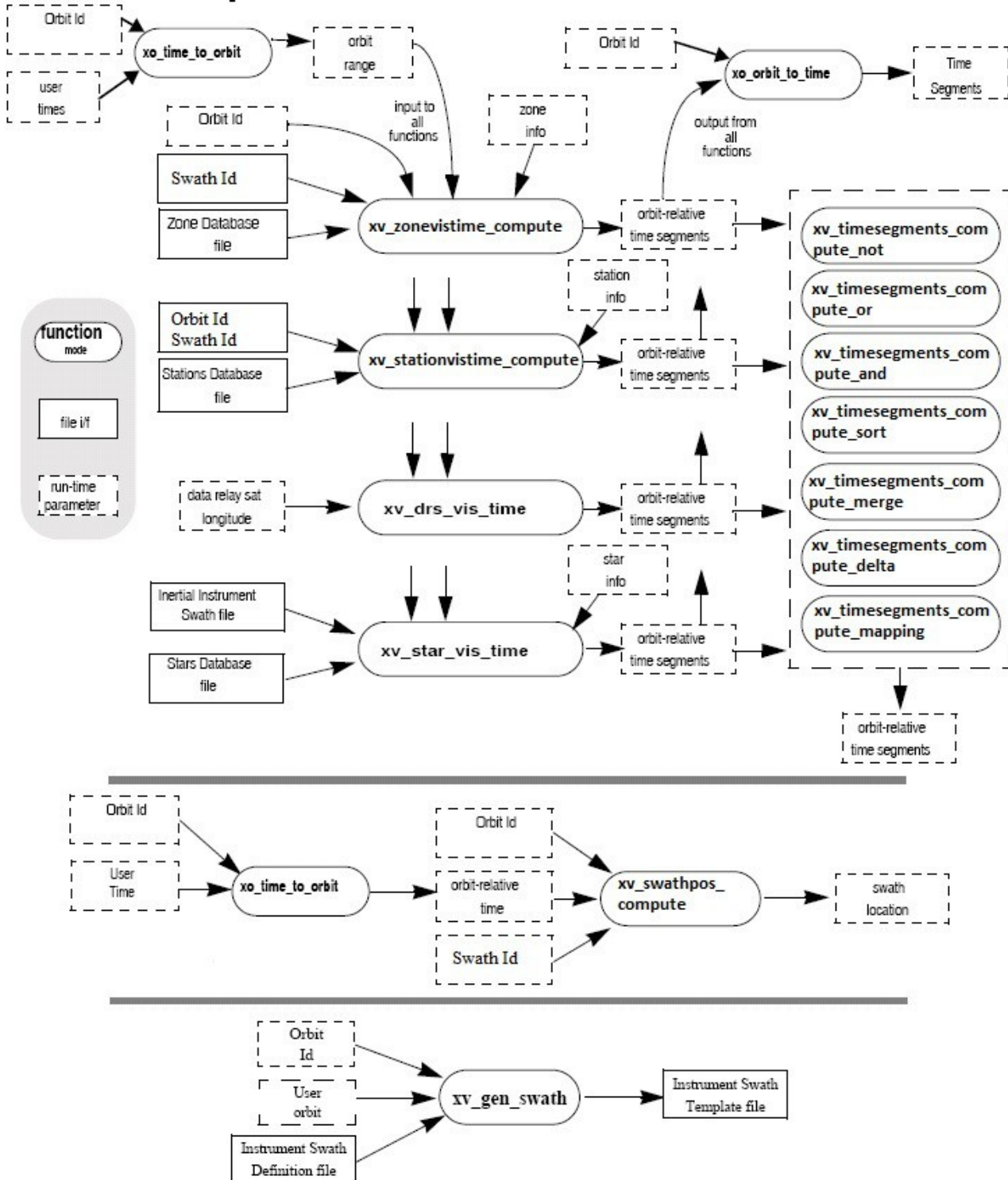

Figure 1: EO\_VISIBILITY Data Flow

## **5 LIBRARY INSTALLATION**

For a detailed description of the installation of any CFI library, please refer to [GEN\_SUM].

Note that example data files are provided with this CFI.

## 6 LIBRARY USAGE

The EO\_VISIBILITY software library has the following dependencies:

- Other EO\_CFI libraries:
  - EO\_FILE\_HANDLING (See [F\_H\_SUM]).
  - EO\_DATA\_HANDLING (See [D\_H\_SUM]).
  - EO\_LIB (See [LIB\_SUM]).
  - EO\_ORBIT (See [ORBIT\_SUM]).
  - EO\_POINTING (See [POINT\_SUM]).
- Third party libraries:
  - POSIX thread library: libpthread.so (Note: this library is normally pre-installed in Linux and MacOS platforms. For Windows platforms, pthread.lib is included in the distribution package, with license LGPL);
  - GEOTIFF, TIFF, PROJ, LIBXML2 libraries (these libraries are included in the distribution package. Their usage terms and conditions are available in the file "TERMS\_AND\_CONDITIONS.TXT" which is part of the distribution package).

In order to improve run-time performance, Some pointing functions (see section 7.88, 7.90, 7.92 of [POINT\_SUM]) perform their computations in multi-threading mode.

The multi-threading code of the Pointing functions uses the OpenMP API (see <http://en.wikipedia.org/wiki/OpenMP>).

OpenMP is not supported in the clang compiler, therefore such functions work in single-thread mode in MacOS.

The following is required to compile and link a Software application that uses the EO\_VISIBILITY software library functions (it is assumed that the required EO\_CFI and third-part libraries are located in directory *cfi\_lib\_dir* and the required header files are located in *cfi\_include*, see [GEN\_SUM] for installation procedures):

1) include the following header files in the source code:

- explorer\_visibility.h (for a C application)

2) use the following compile and link options:

Linux platforms:

`-Icfi_include_dir -Lcfi_lib_dir -lexplorer_visibility`

`-lexplorer_pointing -lexplorer_orbit -lexplorer_lib -lexplorer_data_dandling -lexplorer_file_handling -lgeotiff -ltiff -lproj -lxml2 -lm -lc -lpthread -fopenmp`

MacOS platforms (openmp is not supported)

`-Icfi_include_dir -Lcfi_lib_dir -lexplorer_visibility`

`-lexplorer_pointing -lexplorer_orbit -lexplorer_lib -lexplorer_data_dandling -lexplorer_file_handling -lgeotiff -ltiff -lproj -lxml2 -lm -lc -lpthread`

Windows platforms:

/I "cfi\_include\_dir" /libpath:"cfi\_lib\_dir" libexplorer\_visibility.lib

libexplorer\_pointing.lib libexplorer\_orbit.lib libexplorer\_lib.lib libexplorer\_data\_handling.lib  
 libexplorer\_file\_handling.lib libgeotiff.lib libtiff.lib libproj.lib libxml2.lib pthread.lib /openmp

All functions described in this document have a name starting with the prefix `xv_`.

To avoid problems in linking a user application with the `EO_VISIBILITY` software library due to the existence of names multiple defined, the user application should avoid naming any global software item beginning with either the prefix `XV_` or `xv_`.

This is summarized in Table 2.

**Table 2: CFI functions included within `EO_VISIBILITY` library**

| Function Name                            | Enumeration value                         | long |
|--|---|------|
| Main CFI Functions                       |   |      |
| <code>xv_zone_vis_time</code>            | <code>XV_ZONE_VIS_TIME_ID</code>          | 0    |
| <code>xv_zone_vis_time_no_file</code>    |   |      |
| <code>xv_station_vis_time</code>         | <code>XV_STATION_VIS_TIME_ID</code>       | 1    |
| <code>xv_station_vis_time_no_file</code> |   |      |
| <code>xv_sc_vis_time</code>              | <code>XV_SC_VIS_TIME_ID</code>            | 2    |
| <code>xv_swath_pos_id</code>             | <code>XV_SWATH_POS_ID</code>              | 3    |
| <code>xv_star_vis_time</code>            | <code>XV_STAR_VIS_TIME_ID</code>          | 4    |
| <code>xv_multizones_vis_time</code>      | <code>XV_MULTIZONES_VIS_TIME_ID</code>    | 5    |
| <code>xv_multistations_vis_time</code>   | <code>XV_MULTISTATIONS_VIS_TIME_ID</code> | 6    |
| <code>xv_time_segments_not</code>        | <code>XV_TIME_SEGMENTS_NOT_ID</code>      | 7    |
| <code>xv_time_segments_or</code>         | <code>XV_TIME_SEGMENTS_OR_ID</code>       | 8    |
| <code>xv_time_segments_and</code>        | <code>XV_TIME_SEGMENTS_AND_ID</code>      | 9    |
| <code>xv_time_segments_sort</code>       | <code>XV_TIME_SEGMENTS_SORT_ID</code>     | 10   |
| <code>xv_time_segments_merge</code>      | <code>XV_TIME_SEGMENTS_MERGE_ID</code>    | 11   |
| <code>xv_time_segments_delta</code>      | <code>XV_TIME_SEGMENTS_DELTA_ID</code>    | 12   |
| <code>xv_time_segments_mapping</code>    | <code>XV_TIME_SEGMENTS_MAPPING_ID</code>  | 13   |
| <code>xv_orbit_extra</code>              | <code>XV_ORBIT_EXTRA_ID</code>            | 14   |
| <code>xv_gen_scf</code>                  | <code>XV_GEN_SCF_ID</code>                | 15   |
| <code>xv_gen_swath</code>                | <code>XV_GEN_SWATH_ID</code>              | 16   |
| <code>xv_gen_swath_no_file</code>        |   |      |
| <code>xv_swath_id_init</code>            | <code>XV_SWATH_ID_INIT_ID</code>          | 17   |

|                                 |                                    |    |
|---------------------------------|------------------------------------|----|
| xv_swath_id_close               | XV_SWATH_ID_CLOSE_ID               | 18 |
| xv_zonevistime_compute          | XV_ZONEVISTIME_COMPUTE_ID          | 19 |
| xv_stationvistime_compute       | XV_STATIONVISTIME_COMPUTE_ID       | 20 |
| xv_swathpos_compute             | XV_SWATHPOS_COMPUTE_ID             | 21 |
| xv_timesegments_compute_not     | XV_TIMESEGMENTS_COMPUTE_NOT_ID     | 22 |
| xv_timesegments_compute_or      | XV_TIMESEGMENTS_COMPUTE_OR_ID      | 23 |
| xv_timesegments_compute_and     | XV_TIMESEGMENTS_COMPUTE_AND_ID     | 24 |
| xv_timesegments_compute_sort    | XV_TIMESEGMENTS_COMPUTE_SORT_ID    | 25 |
| xv_timesegments_compute_merge   | XV_TIMESEGMENTS_COMPUTE_MERGE_ID   | 26 |
| xv_timesegments_compute_delta   | XV_TIMESEGMENTS_COMPUTE_DELTA_ID   | 27 |
| xv_timesegments_compute_mapping | XV_TIMESEGMENTS_COMPUTE_MAPPING_ID | 28 |
| Error Handling Functions        |                                    |    |
| xv_verbose                      | not applicable                     |    |
| xv_silent                       |                                    |    |
| xv_get_code                     |                                    |    |
| xv_get_msg                      |                                    |    |
| xv_print_msg                    |                                    |    |

Notes about the table:

- To transform the status vector returned by a CFI function to either a list of error codes or list of error messages, the enumeration value (or the corresponding integer value) described in the table must be used.
- The error handling functions have no enumerated value.

## 6.1 Usage hints

Every CFI function has a different length of the Error Vector, used in the calling I/F examples of this SUM and defined at the beginning of the library header file. In order to provide the user with a single value that could be used as Error Vector length for every function, a generic value has been defined (XV\_ERR\_VECTOR\_MAX\_LENGTH) as the maximum of all the Error Vector lengths. This value can therefore be safely used for every call of functions of this library.

## 6.2 General enumerations

The aim of the current section is to present the enumeration values that can be used rather than integer parameters for some of the input parameters of the EO\_VISIBILITY routines, as shown in the table below. The enumerations presented in [GEN\_SUM] are also applicable.

**Table 3: Some enumerations within EO\_VISIBILITY library**

| Input                              | Description   | Enumeration value | Long |
|------------------------------------|---|-------------------|------|
| Orbit type /<br>Order Criteria     | Absolute Orbit  | XV_ORBIT_ABS      | 0    |
|                                    | Relative Orbit  | XV_ORBIT_REL      | 1    |
| zone_vis_time cover<br>age outputs | Zone completely covered by<br>swath                             | XV_COMPLETE       | 0    |
|                                    | Left extreme transition found<br>by ZONE_VIS_TIME               | XV_LEFT           | 1    |
|                                    | Right extreme transition<br>found by ZONE_VIS_TIME              | XV_RIGHT          | 2    |
|                                    | Both extreme transition found<br>by ZONE_VIS_TIME               | XV_BOTH           | 3    |
| stat_vis_time mask<br>inputs       | AOS, LOS and physical<br>masks                                  | XV_COMBINE        | 0    |
|                                    | AOS, LOS masks  | XV_AOS_LOS        | 1    |
|                                    | Physical mask only  | XV_PHYSICAL       | 2    |
|                                    | Mask as from Station file                                       | XV_FROM_FILE      | 3    |
| star_vis_time cover<br>age outputs | Visibility stars/ends at the<br>first/last FOV in star_vis_time | XV_STAR_UNDEFINED | 0    |
|                                    | Visibility stars/ends at the<br>upper FOV in star_vis_time      | XV_STAR_UPPER     | 1    |
|                                    | Visibility stars/ends at the<br>lower FOV in star_vis_time      | XV_STAR_LOWER     | 2    |
|                                    | Visibility stars/ends at the left<br>FOV in star_vis_time       | XV_STAR_LEFT      | 3    |
|                                    | Visibility stars/ends at the<br>right FOV in star_vis_time      | XV_STAR_RIGHT     | 4    |
| Order enumeration                  | Input Segments ordered by<br>start time                         | XV_TIME_ORDER     | 0    |
|                                    | Input Segments not ordered<br>by start time                     | XV_NO_TIME_ORDER  | 1    |
| Segments direction                 | Ascending segment   | XV_ASCENDING      | 0    |
|                                    | Descending segment  | XV_DESCENDING     | 1    |
| Swath flag                         | Swath Template File   | XV_STF            | 0    |
|                                    | Swath Definition File   | XV_SDF            | 1    |
| Swath id initialization            | File automatic  | XV_FILE_AUTO      | 0    |
|                                    | Swath definition file   | XV_FILE_SDF       | 1    |
|                                    | Swath template file   | XV_FILE_STF       | 2    |
|                                    | Swath definition data   | XV_SDF_DATA       | 3    |

|                               |  |                                       |   |
|-------------------------------|--|---------------------------------------|---|
|                               | Swath template data  | XV_STF_DATA                           | 4 |
| Zone type                     | Use zone database  | XV_USE_ZONE_DB_FILE                   | 0 |
|                               | Use zone data  | XV_USE_ZONE_DATA                      | 1 |
| Extra information computation | Do not compute extra information   | XV_DO_NOT_COMPUTE                     | 0 |
|                               | Compute extra information  | XV_COMPUTE                            | 1 |
| Station type                  | Use station file   | XV_USE_STATION_FILE                   | 0 |
|                               | Use station data   | XV_USE_STATION_DATA                   | 1 |
|                               | Use station file and default mask  | XV_USE_STATION_FILE_AND_MASK_OVERRIDE | 2 |
|                               | Use station data and default mask  | XV_USE_STATION_DATA_AND_MASK_OVERRIDE | 3 |
| Segment time type             | UTC time provided  | XV.UTC_TYPE                           | 0 |
|                               | Orbit data provided  | XV_ORBIT_TYPE                         | 1 |
|                               | UTC time and orbit data provided   | XV_BOTH_TYPE                          | 2 |
| Coverage computation type     | Coverage computation of point database done with a fixed distance between points | XV_COVERAGE_FIXED_DISTANCE            | 0 |
|                               | Coverage computation performance aiming a given percentage of precision          | XV_COVERAGE_PERCENTAGE_PRECISION      | 1 |

The use of the previous enumeration values could be restricted by the particular usage within the different CFI functions. The actual range to be used is indicated within a dedicated reference named **allowed range**. When there are not restrictions to be mentioned, the allowed range column is populated with the label **complete**.

## 6.3 Data Structures

The aim of the current section is to present the data structures that are used in the EO\_LIB library. The structures are currently used for the CFI Identifiers accessor functions. The following table show the structures with their names and the data that contain:



**Table 4: EO\_VISIBILITY structures**

| Structure name | Data          |                      |   |
|----------------|---------------|----------------------|---|
|                | Variable Name | C type               | Description   |
| xv_az_el_mask  | num_mask_pt   | long                 | Number of azimuth and elevation pairs defining the antenna mask   |
|                | status        | long                 | <p>Allow the user to enable/disable masks;</p> <p>The behaviour of the status field is described below for each type of mask:</p> <p><b>Inclusive mask:</b><br/>           Status = disabled: no constraints (regardless of number of points)<br/>           Status = enabled and number of points = 0 : no constraints</p> <p><b>Exclusive mask:</b><br/>           Status = disabled : mask is ignored (regardless of number of points)<br/>           Status = enabled and number of points = 0 : mask is ignored</p> <p><b>Combining the two above:</b><br/>           Each mask define a polygon.<br/>           Forbidden areas are:<br/>           1) the area OUTSIDE the inclusive polygon;<br/>           2) the area INSIDE the exclusive polygon;</p> |
|                | azimuth       | double [XD_VERTICES] | Azimuth defining the antenna mask   |
|                | elevation     | double [XD_VERTICES] | Elevation defining the antenna mask   |
| xv_link_mask   | incl_mask     | xv_az_el_mask        | List of azimuth and elevation pairs in Instrument Frame defining an inclusive zone  |
|                | excl_mask     | xv_az_el_mask        | List of azimuth and elevation pairs in Instrument Frame defining an exclusive zone  |
| xv_link_data   | mask_data     | xv_link_mask         | List of azimuth and elevation pairs in Instrument Frame   |
|                | min_tg_height | double               | Minimum tangent height  |

| Structure name | Data             |                      |   |
|----------------|------------------|----------------------|---|
|                | Variable Name    | C type               | Description   |
| xv_az_el_mask  | num_mask_pt      | long                 | Number of azimuth and elevation pairs defining the antenna mask   |
|                | status           | long                 | <p>Allow the user to enable/disable masks;</p> <p>The behaviour of the status field is described below for each type of mask:</p> <p><b>Inclusive mask:</b></p> <p>Status = disabled: no constraints (regardless of number of points)</p> <p>Status = enabled and number of points = 0 : no constraints</p> <p><b>Exclusive mask:</b></p> <p>Status = disabled : mask is ignored (regardless of number of points)</p> <p>Status = enabled and number of points = 0 : mask is ignored</p> <p><b>Combining the two above:</b></p> <p>Each mask define a polygon.</p> <p>Forbidden areas are:</p> <p>1) the area OUTSIDE the inclusive polygon;</p> <p>2) the area INSIDE the exclusive polygon;</p> |
|                | azimuth          | double [XD_VERTICES] | Azimuth defining the antenna mask   |
|                | elevation        | double [XD_VERTICES] | Elevation defining the antenna mask   |
| xv_swath_info  | type             | long                 | Initialization type (Swath initialization type enum)  |
|                | filename         | char*                | File name   |
|                | sdf_file         | xd_sdf_file*         | Swath definition data   |
|                | stf_file         | xd_stf_file*         | Swath template data   |
|                | nof_regen_orbits | long                 | Number of orbit for STF regeneration (for SDF initializations)  |

| Structure name | Data          |                      |   |
|----------------|---------------|----------------------|---|
|                | Variable Name | C type               | Description   |
| xv_az_el_mask  | num_mask_pt   | long                 | Number of azimuth and elevation pairs defining the antenna mask   |
|                | status        | long                 | <p>Allow the user to enable/disable masks;</p> <p>The behaviour of the status field is described below for each type of mask:</p> <p><b>Inclusive mask:</b></p> <p>Status = disabled: no constraints (regardless of number of points)</p> <p>Status = enabled and number of points = 0 : no constraints</p> <p><b>Exclusive mask:</b></p> <p>Status = disabled : mask is ignored (regardless of number of points)</p> <p>Status = enabled and number of points = 0 : mask is ignored</p> <p><b>Combining the two above:</b></p> <p>Each mask define a polygon.</p> <p>Forbidden areas are:</p> <p>1) the area OUTSIDE the inclusive polygon;</p> <p>2) the area INSIDE the exclusive polygon;</p> |
|                | azimuth       | double [XD_VERTICES] | Azimuth defining the antenna mask   |
|                | elevation     | double [XD_VERTICES] | Elevation defining the antenna mask   |
| xv_time        | type          | long                 | Time type (see Segment time type enum)  |
|                | utc_time      | double               | UTC time (processing days)  |
|                | orbit_type    | long                 | Orbit type (see Orbit type enum)  |
|                | orbit_num     | long                 | Orbit number  |
|                | cycle         | long                 | Cycle number  |
|                | sec           | long                 | Seconds since ascending node  |
|                | msec          | long                 | Microseconds since ascending node   |

| Structure name   | Data          |                      |   |
|------------------|---------------|----------------------|---|
|                  | Variable Name | C type               | Description   |
| xv_az_el_mask    | num_mask_pt   | long                 | Number of azimuth and elevation pairs defining the antenna mask   |
|                  | status        | long                 | <p>Allow the user to enable/disable masks;</p> <p>The behaviour of the status field is described below for each type of mask:</p> <p><b>Inclusive mask:</b></p> <p>Status = disabled: no constraints (regardless of number of points)</p> <p>Status = enabled and number of points = 0 : no constraints</p> <p><b>Exclusive mask:</b></p> <p>Status = disabled : mask is ignored (regardless of number of points)</p> <p>Status = enabled and number of points = 0 : mask is ignored</p> <p><b>Combining the two above:</b></p> <p>Each mask define a polygon.</p> <p>Forbidden areas are:</p> <p>1) the area OUTSIDE the inclusive polygon;</p> <p>2) the area INSIDE the exclusive polygon;</p> |
|                  | azimuth       | double [XD_VERTICES] | Azimuth defining the antenna mask   |
|                  | elevation     | double [XD_VERTICES] | Elevation defining the antenna mask   |
| xv_time_interval | tstart        | xv_time              | Interval start time   |
|                  | tstop         | xv_time              | Interval stop time  |

| Structure name        | Data          |                      |   |
|-----------------------|---------------|----------------------|---|
|                       | Variable Name | C type               | Description   |
| xv_az_el_mask         | num_mask_pt   | long                 | Number of azimuth and elevation pairs defining the antenna mask   |
|                       | status        | long                 | <p>Allow the user to enable/disable masks;</p> <p>The behaviour of the status field is described below for each type of mask:</p> <p><b>Inclusive mask:</b></p> <p>Status = disabled: no constraints (regardless of number of points)</p> <p>Status = enabled and number of points = 0 : no constraints</p> <p><b>Exclusive mask:</b></p> <p>Status = disabled : mask is ignored (regardless of number of points)</p> <p>Status = enabled and number of points = 0 : mask is ignored</p> <p><b>Combining the two above:</b></p> <p>Each mask define a polygon.</p> <p>Forbidden areas are:</p> <p>1) the area OUTSIDE the inclusive polygon;</p> <p>2) the area INSIDE the exclusive polygon;</p> |
|                       | azimuth       | double [XD_VERTICES] | Azimuth defining the antenna mask   |
|                       | elevation     | double [XD_VERTICES] | Elevation defining the antenna mask   |
| xv_zone_coverage_info | zone_id       | char*                | Zone name   |
|                       | coverage      | long                 | <p>Zone coverage flag for segment</p> <p>= 0 Zone completely covered by swath</p> <p>= 1 Zone not completely covered by swath, extending over the left edge of the swath.</p> <p>= 2 Zone not completely covered by swath, extending over the right edge of the swath.</p> <p>= 3 Zone not completely covered by swath, extending over both edges of</p>  |

| Structure name                  | Data                    |                            |   |
|---------------------------------|-------------------------|----------------------------|---|
|                                 | Variable Name           | C type                     | Description   |
| xv_az_el_mask                   | num_mask_pt             | long                       | Number of azimuth and elevation pairs defining the antenna mask   |
|                                 | status                  | long                       | <p>Allow the user to enable/disable masks;</p> <p>The behaviour of the status field is described below for each type of mask:</p> <p><b>Inclusive mask:</b></p> <p>Status = disabled: no constraints (regardless of number of points)</p> <p>Status = enabled and number of points = 0 : no constraints</p> <p><b>Exclusive mask:</b></p> <p>Status = disabled : mask is ignored (regardless of number of points)</p> <p>Status = enabled and number of points = 0 : mask is ignored</p> <p><b>Combining the two above:</b></p> <p>Each mask define a polygon.</p> <p>Forbidden areas are:</p> <p>1) the area OUTSIDE the inclusive polygon;</p> <p>2) the area INSIDE the exclusive polygon;</p> |
|                                 | azimuth                 | double [XD_VERTICES]       | Azimuth defining the antenna mask   |
|                                 | elevation               | double [XD_VERTICES]       | Elevation defining the antenna mask   |
| xv_zone_coverage_info_list      | num_rec                 | long                       | Number of zones   |
|                                 | zone_coverage_info      | xv_zone_coverage_info      | List of zones with coverage   |
| xv_zonevisibility_interval      | time_interval           | xv_time_interval           | Segment start and stop  |
|                                 | zone_coverage_info_list | xv_zone_coverage_info_list | Coverage information  |
| xv_zonevisibility_interval_list | num_rec                 | long                       | Number of segments  |
|                                 | visibility_interval     | xv_zonevisibility_interval | List of segments  |

| Structure name | Data             |                      |   |
|----------------|------------------|----------------------|---|
|                | Variable Name    | C type               | Description   |
| xv_az_el_mask  | num_mask_pt      | long                 | Number of azimuth and elevation pairs defining the antenna mask   |
|                | status           | long                 | <p>Allow the user to enable/disable masks;</p> <p>The behaviour of the status field is described below for each type of mask:</p> <p><b>Inclusive mask:</b></p> <p>Status = disabled: no constraints (regardless of number of points)</p> <p>Status = enabled and number of points = 0 : no constraints</p> <p><b>Exclusive mask:</b></p> <p>Status = disabled : mask is ignored (regardless of number of points)</p> <p>Status = enabled and number of points = 0 : mask is ignored</p> <p><b>Combining the two above:</b></p> <p>Each mask define a polygon.</p> <p>Forbidden areas are:</p> <p>1) the area OUTSIDE the inclusive polygon;</p> <p>2) the area INSIDE the exclusive polygon;</p> |
|                | azimuth          | double [XD_VERTICES] | Azimuth defining the antenna mask   |
|                | elevation        | double [XD_VERTICES] | Elevation defining the antenna mask   |
| xv_zone_info   | zone_id          | char*                | Zone name   |
|                | type             | type                 | Zone type (see Zone type enum)  |
|                | zone_db_filename | char*                | Zone database name  |
|                | zone_data        | xd_zone_rec*         | Zone record information   |
|                | projection       | long                 | Projection (see projection enum)  |
|                | min_duration     | double               | Minimum segment duration (seconds)  |

| Structure name    | Data          |                      |   |
|-------------------|---------------|----------------------|---|
|                   | Variable Name | C type               | Description   |
| xv_az_el_mask     | num_mask_pt   | long                 | Number of azimuth and elevation pairs defining the antenna mask   |
|                   | status        | long                 | <p>Allow the user to enable/disable masks;</p> <p>The behaviour of the status field is described below for each type of mask:</p> <p><b>Inclusive mask:</b></p> <p>Status = disabled: no constraints (regardless of number of points)</p> <p>Status = enabled and number of points = 0 : no constraints</p> <p><b>Exclusive mask:</b></p> <p>Status = disabled : mask is ignored (regardless of number of points)</p> <p>Status = enabled and number of points = 0 : mask is ignored</p> <p><b>Combining the two above:</b></p> <p>Each mask define a polygon.</p> <p>Forbidden areas are:</p> <p>1) the area OUTSIDE the inclusive polygon;</p> <p>2) the area INSIDE the exclusive polygon;</p> |
|                   | azimuth       | double [XD_VERTICES] | Azimuth defining the antenna mask   |
|                   | elevation     | double [XD_VERTICES] | Elevation defining the antenna mask   |
| xv_zone_info_list | calc_flag     | long                 | Flag to tell if extra information must be computed (see extra information compute flag enum)  |
|                   | num_rec       | long                 | Number of zones   |
|                   | zone_info     | xv_zone_info*        | List of zones.  |



| Structure name  | Data                |                      |   |
|-----------------|---------------------|----------------------|---|
|                 | Variable Name       | C type               | Description   |
| xv_az_el_mask   | num_mask_pt         | long                 | Number of azimuth and elevation pairs defining the antenna mask   |
|                 | status              | long                 | <p>Allow the user to enable/disable masks;</p> <p>The behaviour of the status field is described below for each type of mask:</p> <p><b>Inclusive mask:</b></p> <p>Status = disabled: no constraints (regardless of number of points)</p> <p>Status = enabled and number of points = 0 : no constraints</p> <p><b>Exclusive mask:</b></p> <p>Status = disabled : mask is ignored (regardless of number of points)</p> <p>Status = enabled and number of points = 0 : mask is ignored</p> <p><b>Combining the two above:</b></p> <p>Each mask define a polygon.</p> <p>Forbidden areas are:</p> <p>1) the area OUTSIDE the inclusive polygon;</p> <p>2) the area INSIDE the exclusive polygon;</p> |
|                 | azimuth             | double [XD_VERTICES] | Azimuth defining the antenna mask   |
|                 | elevation           | double [XD_VERTICES] | Elevation defining the antenna mask   |
| xv_station_info | type                | long                 | See station type enum.  |
|                 | station_id          | char*                | Station name  |
|                 | station_db_filename | char*                | Station database  |
|                 | station_data        | xd_station_rec*      | Station data  |
|                 | default_aos         | double               | Default AOS elevation   |
|                 | default_los         | double               | Default LOS elevation   |
|                 | default_mask        | long                 | Default mask  |

| Structure name           | Data          |                      |   |
|--------------------------|---------------|----------------------|---|
|                          | Variable Name | C type               | Description   |
| xv_az_el_mask            | num_mask_pt   | long                 | Number of azimuth and elevation pairs defining the antenna mask   |
|                          | status        | long                 | <p>Allow the user to enable/disable masks;</p> <p>The behaviour of the status field is described below for each type of mask:</p> <p><b>Inclusive mask:</b></p> <p>Status = disabled: no constraints (regardless of number of points)</p> <p>Status = enabled and number of points = 0 : no constraints</p> <p><b>Exclusive mask:</b></p> <p>Status = disabled : mask is ignored (regardless of number of points)</p> <p>Status = enabled and number of points = 0 : mask is ignored</p> <p><b>Combining the two above:</b></p> <p>Each mask define a polygon.</p> <p>Forbidden areas are:</p> <p>1) the area OUTSIDE the inclusive polygon;</p> <p>2) the area INSIDE the exclusive polygon;</p> |
|                          | azimuth       | double [XD_VERTICES] | Azimuth defining the antenna mask   |
|                          | elevation     | double [XD_VERTICES] | Elevation defining the antenna mask   |
| xv_station_info_list     | calc_flag     | long                 | Flag to tell if extra information must be computed (see extra information compute flag enum)  |
|                          | num_rec       | long                 | Number of stations  |
|                          | station_info  | xv_station_info*     | List of stations.   |
| xv_station_coverage_info | station_id    | char*                | Name of the station   |
|                          | zdop_time     | xv_time              | Zero doppler time   |

| Structure name                     | Data                       |                               |   |
|------------------------------------|----------------------------|-------------------------------|---|
|                                    | Variable Name              | C type                        | Description   |
| xv_az_el_mask                      | num_mask_pt                | long                          | Number of azimuth and elevation pairs defining the antenna mask   |
|                                    | status                     | long                          | <p>Allow the user to enable/disable masks;</p> <p>The behaviour of the status field is described below for each type of mask:</p> <p><b>Inclusive mask:</b></p> <p>Status = disabled: no constraints (regardless of number of points)</p> <p>Status = enabled and number of points = 0 : no constraints</p> <p><b>Exclusive mask:</b></p> <p>Status = disabled : mask is ignored (regardless of number of points)</p> <p>Status = enabled and number of points = 0 : mask is ignored</p> <p><b>Combining the two above:</b></p> <p>Each mask define a polygon.</p> <p>Forbidden areas are:</p> <p>1) the area OUTSIDE the inclusive polygon;</p> <p>2) the area INSIDE the exclusive polygon;</p> |
|                                    | azimuth                    | double [XD_VERTICES]          | Azimuth defining the antenna mask   |
|                                    | elevation                  | double [XD_VERTICES]          | Elevation defining the antenna mask   |
| xv_station_coverage_info_list      | num_rec                    | long                          | Number of stations with coverage information  |
|                                    | station_coverage_info      | xv_station_coverage_info*     | List of stations  |
| xv_stationvisibility_interval      | time_interval              | xv_time_interval              | Segment start/stop information  |
|                                    | station_coverage_info_list | xv_station_coverage_info_list | Segment extra information   |
| xv_stationvisibility_interval_list | num_rec                    | long                          | Number of segments  |
|                                    | visibility_interval        | xv_stationvisibility_interval | List of segments  |

| Structure name         | Data          |                      |   |
|------------------------|---------------|----------------------|---|
|                        | Variable Name | C type               | Description   |
| xv_az_el_mask          | num_mask_pt   | long                 | Number of azimuth and elevation pairs defining the antenna mask   |
|                        | status        | long                 | <p>Allow the user to enable/disable masks;</p> <p>The behaviour of the status field is described below for each type of mask:</p> <p><b>Inclusive mask:</b></p> <p>Status = disabled: no constraints (regardless of number of points)</p> <p>Status = enabled and number of points = 0 : no constraints</p> <p><b>Exclusive mask:</b></p> <p>Status = disabled : mask is ignored (regardless of number of points)</p> <p>Status = enabled and number of points = 0 : mask is ignored</p> <p><b>Combining the two above:</b></p> <p>Each mask define a polygon.</p> <p>Forbidden areas are:</p> <p>1) the area OUTSIDE the inclusive polygon;</p> <p>2) the area INSIDE the exclusive polygon;</p> |
|                        | azimuth       | double [XD_VERTICES] | Azimuth defining the antenna mask   |
|                        | elevation     | double [XD_VERTICES] | Elevation defining the antenna mask   |
| xv_swath_point         | lon           | double               | Longitude   |
|                        | lat           | double               | Latitude  |
|                        | alt           | double               | Altitude  |
| xv_swath_point_list    | num_rec       | long                 | Number of points  |
|                        | swath_point   | xv_swath_point*      | List of swath points  |
| xv_visibility_interval | time_interval | xv_time_interval     | Time interval   |

| Structure name              | Data                |                         |   |
|-----------------------------|---------------------|-------------------------|---|
|                             | Variable Name       | C type                  | Description   |
| xv_az_el_mask               | num_mask_pt         | long                    | Number of azimuth and elevation pairs defining the antenna mask   |
|                             | status              | long                    | <p>Allow the user to enable/disable masks;</p> <p>The behaviour of the status field is described below for each type of mask:</p> <p><b>Inclusive mask:</b></p> <p>Status = disabled: no constraints (regardless of number of points)</p> <p>Status = enabled and number of points = 0 : no constraints</p> <p><b>Exclusive mask:</b></p> <p>Status = disabled : mask is ignored (regardless of number of points)</p> <p>Status = enabled and number of points = 0 : mask is ignored</p> <p><b>Combining the two above:</b></p> <p>Each mask define a polygon.</p> <p>Forbidden areas are:</p> <p>1) the area OUTSIDE the inclusive polygon;</p> <p>2) the area INSIDE the exclusive polygon;</p> |
|                             | azimuth             | double [XD_VERTICES]    | Azimuth defining the antenna mask   |
|                             | elevation           | double [XD_VERTICES]    | Elevation defining the antenna mask   |
| xv_visibility_interval_list | num_rec             | long                    | Number of segments  |
|                             | visibility_interval | xv_visibility_interval* | List of segments  |

| Structure name                | Data                |                      |   |
|-------------------------------|---------------------|----------------------|---|
|                               | Variable Name       | C type               | Description   |
| xv_az_el_mask                 | num_mask_pt         | long                 | Number of azimuth and elevation pairs defining the antenna mask   |
|                               | status              | long                 | <p>Allow the user to enable/disable masks;</p> <p>The behaviour of the status field is described below for each type of mask:</p> <p><b>Inclusive mask:</b></p> <p>Status = disabled: no constraints (regardless of number of points)</p> <p>Status = enabled and number of points = 0 : no constraints</p> <p><b>Exclusive mask:</b></p> <p>Status = disabled : mask is ignored (regardless of number of points)</p> <p>Status = enabled and number of points = 0 : mask is ignored</p> <p><b>Combining the two above:</b></p> <p>Each mask define a polygon.</p> <p>Forbidden areas are:</p> <p>1) the area OUTSIDE the inclusive polygon;</p> <p>2) the area INSIDE the exclusive polygon;</p> |
|                               | azimuth             | double [XD_VERTICES] | Azimuth defining the antenna mask   |
|                               | elevation           | double [XD_VERTICES] | Elevation defining the antenna mask   |
| xv_zonevisibility_coverage_in | type_coverage       | long                 | Coverage type (see XV_Type_Coverage_enum)   |
|                               | point_geod_distance | double               | Geodetic distance between points [km]   |
|                               | percent_precision   | double               | Expected precision. The closer to 100%, the more accurate the computations  |
|                               | orbit_id            | xo_orbit_id*         | Orbit id  |
|                               | attitude_def        | xp_attitude_def*     | Attitude definition   |
|                               | swath_id            | xv_swath_id*         | Swath id  |

| Structure name                 | Data                    |                      |   |
|--------------------------------|-------------------------|----------------------|---|
|                                | Variable Name           | C type               | Description   |
| xv_az_el_mask                  | num_mask_pt             | long                 | Number of azimuth and elevation pairs defining the antenna mask   |
|                                | status                  | long                 | <p>Allow the user to enable/disable masks;</p> <p>The behaviour of the status field is described below for each type of mask:</p> <p><b>Inclusive mask:</b></p> <p>Status = disabled: no constraints (regardless of number of points)</p> <p>Status = enabled and number of points = 0 : no constraints</p> <p><b>Exclusive mask:</b></p> <p>Status = disabled : mask is ignored (regardless of number of points)</p> <p>Status = enabled and number of points = 0 : mask is ignored</p> <p><b>Combining the two above:</b></p> <p>Each mask define a polygon.</p> <p>Forbidden areas are:</p> <p>1) the area OUTSIDE the inclusive polygon;</p> <p>2) the area INSIDE the exclusive polygon;</p> |
|                                | azimuth                 | double [XD_VERTICES] | Azimuth defining the antenna mask   |
|                                | elevation               | double [XD_VERTICES] | Elevation defining the antenna mask   |
| xv_zonevisibility_coverage_out | zone_area               | double               | Zone area in km <sup>2</sup>  |
|                                | total_coverage          | double               | Percentage of zone covered by all intervals, i.e. 100% - percentage of zone not covered by any interval   |
|                                | coverage_per_interval   | double*              | Array, item with index i (0,1,2,...N-1) is the percentage of zone covered by interval i+1 (1,2,...N) only   |
|                                | coverage_by_N_intervals | double*              | Array, item with index i (0,1,2,...N-1) is the percentage of the zone covered by exactly i+1 (1,2,...N) intervals   |
|                                | cumulative_coverage     | double*              | Array, with index i (0,1,2,...N-1) is the percentage of zone covered by   |





## 7 CFI FUNCTIONS DESCRIPTION

The following sections describe each CFI function.

Input and output parameters of each CFI function are described in tables, where C programming language syntax is used to specify:

- Parameter types (e.g. long, double)
- Array sizes of N elements (e.g. param[N])
- Array element M (e.g. [M])

## 7.1 xv\_zone\_vis\_time

### 7.1.1 Overview

**Note:** this function is deprecated. Use `xv_zonevistime_compute` instead.

The `xv_zone_vis_time` function computes all the orbital segments for which a given instrument swath intercepts a user-defined zone at the surface of the Earth ellipsoid.

An orbital segment is a time interval along the orbit, defined by start and stop times expressed as seconds (and microseconds) elapsed since the ascending node crossing.

A user-defined zone can be:

- a polygon specified by a set of latitude and longitude points
- a circle specified by the centre latitude, longitude, and the diameter

Note that particular cases of the above can be used to define the zone as:

- a point
- a line

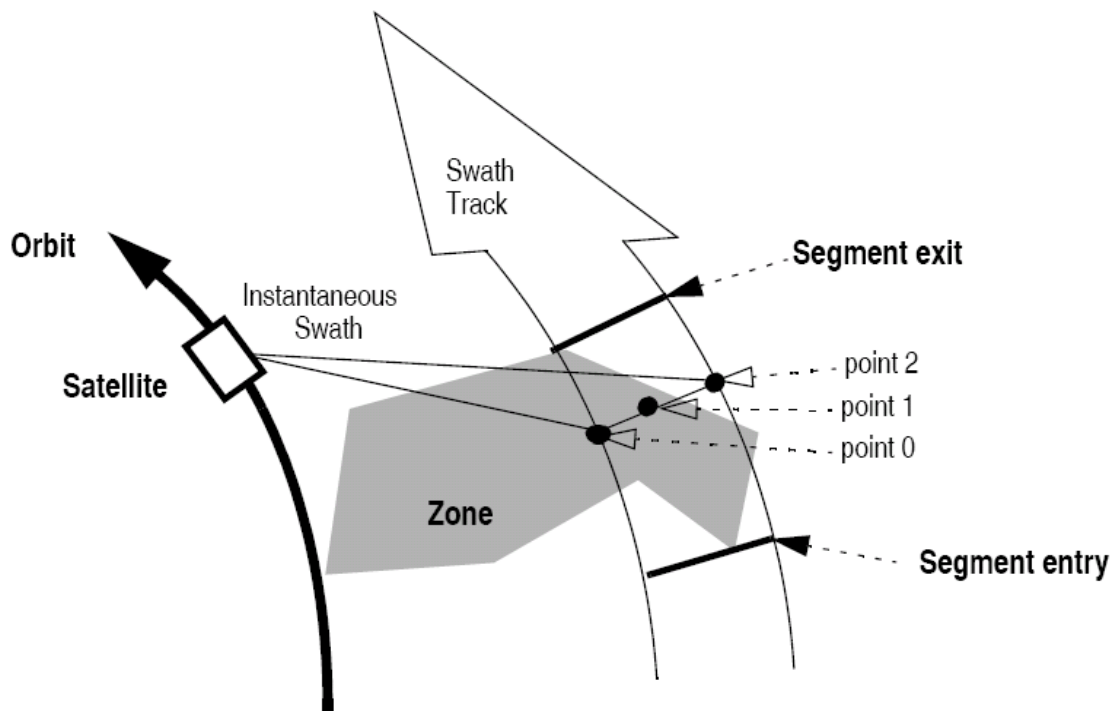

**Figure 2: Segment Definition `xv_zone_vis_time`**

`xv_zone_vis_time` requires access to several data structures and files to produce its results:

- the `orbit_id` (`xo_orbit_id`) providing the orbital data. The `orbit_id` can be initialized with the following data or files, also with precise propagator initialization if applicable (see [ORBIT\_SUM]):
  - data for an orbital change
  - Orbit scenario files
  - Predicted orbit files

- Orbit Event Files (**Note: Orbit Event File is deprecated, only supported for CRYOSAT mission**).
  - Restituted orbit files
  - DORIS Preliminary orbit files
  - DORIS Navigator files
  - TLE files
- Note: if the orbit is initialized for precise propagation, the execution of the visibility function can be very slow. As alternative, a POF can be generated with the precise propagator (function `xo_gen_pof`) for the range of orbits the user usually needs, and use this generated file to initialize the orbit id. The execution time performance will be much better for the visibility function and it will not have a big impact on the precision of the calculations.
- the Instrument Swath File, excluding inertial swath files, describing the area seen by the relevant instrument all along the current orbit. The Swath data can be provided by:
    - A swath template file produced off-line by the EO\_VISIBILITY library (`xv_gen_swath` function).
    - A swath definition file, describing the swath geometry. In this case the `xv_zone_vis_time` generates the swath points for a number of orbits given by the user.
  - optionally, a Zone Database File, containing the zone description. The user can either specify a zone identifier referring to a zone in the file, or provide the zone parameters directly to `xv_zone_vis_time`.

The time intervals used by `xv_zone_vis_time` are expressed in absolute orbit numbers or in relative orbit and cycle numbers. This is valid for both:

- input parameter “Orbit Range”: first and last orbit to be considered. In case of using relative orbits, the corresponding cycle number should be used, otherwise, this the cycle number will be a dummy parameter.
- output parameter “Zone Visibility Segments”: time segments with time expressed as {absolute orbit number (or relative orbit number and cycle number), number of seconds since ascending node, number of microseconds}

The orbit representation (absolute or relative) for the output segments will be the same as in the input orbits. Moreover, the segments will be ordered chronologically.

Users who need to use processing times must make use of the conversion routines provided in EO\_ORBIT (`xo_time_to_orbit` and `xo_orbit_to_time` functions).

**NOTE:** If `xv_zone_vis_time` is used with a range of orbits that includes an orbital change (e.g. change in the repeat cycle or cycle length), the behaviour depends on the swath file introduced as input:

- If a **swath template file** is used, `xv_zone_vis_time` automatically will ignore the orbits that do not correspond with the template file (i.e. no visibility segments will be generated for those orbits), since swath template file is generated from a reference orbit with a particular geometry, so it is not valid for a different geometry.
- If a **swath definition file** is introduced, `xv_zone_vis_time` will perform the computations across orbital changes, and will return the visibility segments corresponding to the whole orbital range. Internally, swath template files valid for every orbital change are generated to perform the calculations.

**NOTE 2:** If a swath template file with the variable header tags *Start\_VValidity\_Range* and *Stop\_VValidity\_Range* is used as input, only the segments belonging to that orbit range will be returned.

**NOTE 3:** If a swath definition file is introduced, it can be also introduced every how many orbits the swath template file must be recomputed (swath\_flag parameter, see section 68). If the orbit\_id has been initialized with an OSF file with MLST non linear terms and the parameter swath\_flag is greater than the linear approximation validity, the recomputation of swath template file will be done every linear approximation validity orbits.

## **7.1.2 Swath Definition**

The swath file is generated using the `xv_gen_swath` function, within the `EO_VISIBILITY` library. There are 3 different types of swaths:

- earth-observing instruments ('nadir curve', 'nadir point' or "area swaths")
- limb-sounding instruments ('limb', narrow or wide)
- limb-sounding instruments observing inertial objects ('inertial')

The following sub-sections provide some details on the various swath definitions.

### **7.1.2.1 Earth-observing Instruments Swath Definition**

The term swath must be clearly defined to understand the explanations in this document:

- instantaneous swath: the part of the earth surface observed by an instrument at a given time
- swath track: represents the track made on the earth surface by the instantaneous swath over a period of time

For instruments observing the surface of the earth, the instantaneous swath is constituted by the point/curve/area on the ground observed by the instrument at a given time. It is calculated taking the earth ellipsoid as a reference for the earth surface. The wider the field-of-view of the instrument, the wider the swath on the ground.

When the satellite moves over a period of time, this point/curve/area defines a band on the earth surface. This constitutes the swath track.

See next figure for an illustration of these definitions.

Note that the terms curve or point are an idealized view of the instrument FOV, which usually have a thickness.

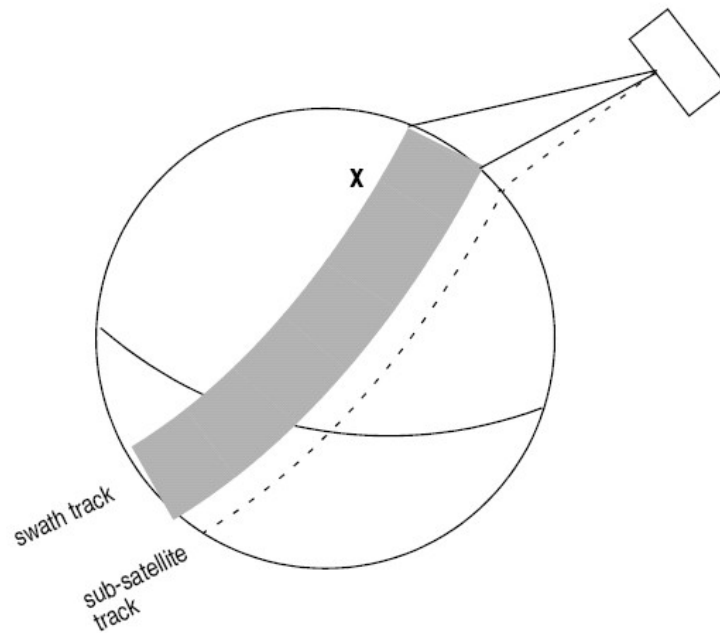

**Figure 3: Earth-observing instrument: swath definition**

### 7.1.2.2 Limb-sounding Instruments Swath Definition

For limb sounding instruments, the concept can be generalized to define a “thick swath”. This is obtained by defining a minimum and a maximum altitude, and considering the tangent points to these altitudes as the edges of the swath. Two cases have to be considered:

- deterministic (narrow) azimuth field of view (e.g. MIPAS sideward-looking): the swath projection on the earth surface is similar to a regular sideward-looking swath, with the lower altitude defining the further swath edge and the higher altitude defining the closer swath edge. See Figure 4.
- non-deterministic (potentially wide) azimuth field of view (e.g. MIPAS rearward-looking): due to the potentially wide azimuth field of view, each altitude defines a swath projection on the earth surface. Depending on the altitude, these swaths are of different width across-track, and also at different distance from the satellite. See Figure 5.

For these, 2 Instrument Swath Files are provided:

- one at the highest altitude
- one at the lowest altitude

The user must handle both swath himself to determine his required visibility time segments

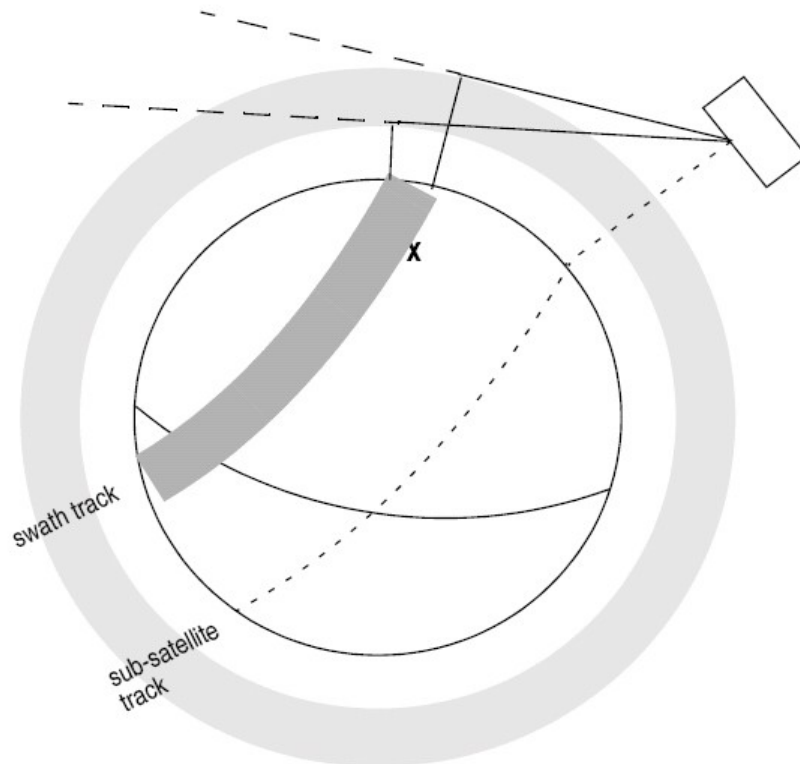

**Figure 4: Limb-sounding instrument: swath definition (1)**

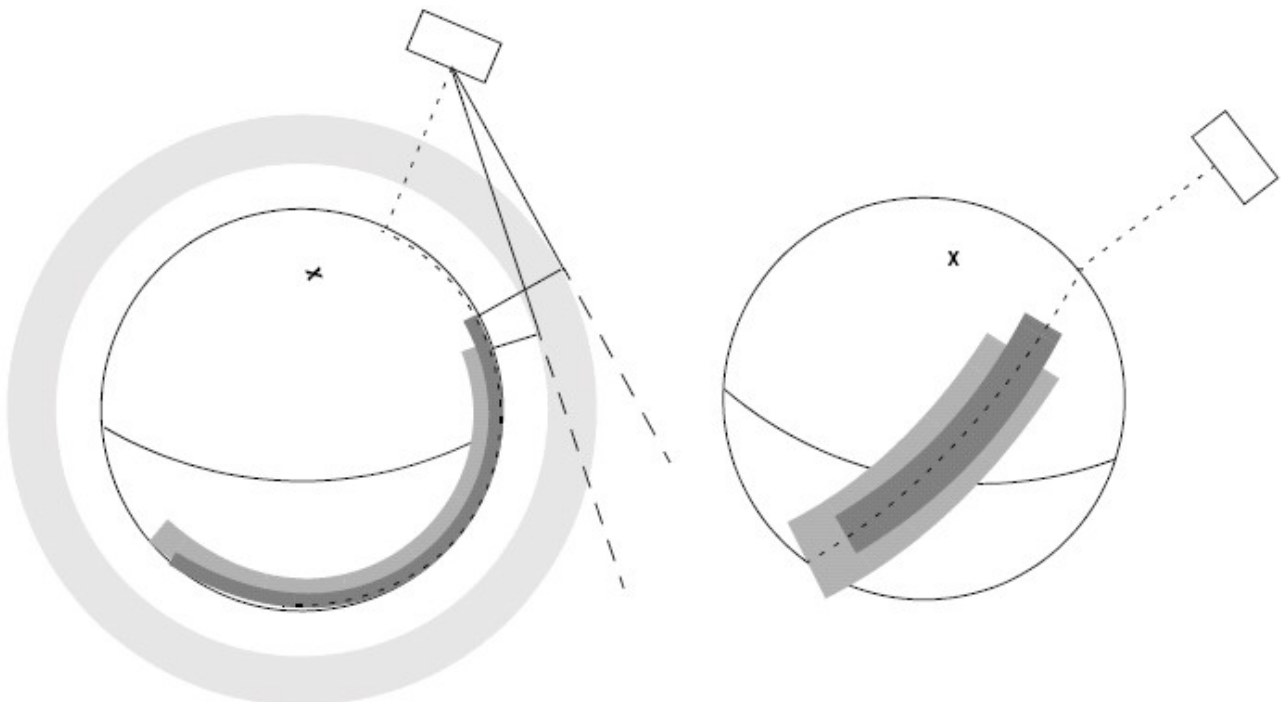

**Figure 5: Limb-sounding instrument: swath definition (2)**

### 7.1.2.3 Limb-sounding Instruments Inertial Swath Definition

This type corresponds to the observation of inertial targets (e.g. Gomos occultation mode and Mipas Line of Sight mode in Envisat). For the CFI function **xv\_star\_vis\_time** the FOV direction in inertial coordinates must be available. Therefore for these instrument modes the direction in inertial space, for a given tangent altitude, is given in the swath template file.

### 7.1.2.4 Swath Definition for Envisat

Next table lists all instrument modes and the relevance of the swaths for Envisat. It shows also:

- the prefix to be used when generating the swath template file name
- the different types of algorithms to be used by **xv\_gen\_swath** (this is transparent to the user)

**Table 5: Envisat Swaths**

| instrument | Mode                              | File Prefix<br>= swath | Swath<br>geometry<br>(Table 90) | Swath Type  | Remarks   |
|------------|-----------------------------------|------------------------|---------------------------------|-------------|---|
| RA         |                                   | RA_2__                 | POINTING (1 point)              | Nadir point | Modeled as sub-satellite track                                    |
| MERIS      | Averaging /<br>Direct & Averaging | MERIS_                 | POINTING (3 points)             | Nadir line  |   |
| ASAR       | Image Modes<br>(IS1... IS7)       | SARxIM<br>(x=1...7)    | ASAR                            | Nadir line  |   |
|            | Alt. Polarization<br>(IS1... IS7) |                        |                                 |             |   |
|            | Wide Swath                        | SARWIM                 |                                 |             |   |
|            | Global Monitoring                 |                        |                                 |             |   |
|            | Wave (IS1... IS7)                 | SARxWV<br>(x=1...7)    |                                 |             | Modeled as a continuous swath<br>any where within the image swath |



|           |                                  |                                |                     |                    |   |
|-----------|----------------------------------|--------------------------------|---------------------|--------------------|---|
| GOMOS     | Occultation                      | GOMOIL<br>GOMOIH               | INERTIAL            | Inertial direction | IFOV much smaller than swath.<br>IFOV Very dependent on star avail ability.<br>2 swaths defined:<br>- 1 for high altitude (GOMOIH)<br>- 1 for low altitude (GOMOIL)   |
|           | Occultation                      | GOMO_H<br>GOMO_L               | LIMB                | Limb wide          | Same mode as above, now swath defined as Earth-fixed location.<br>IFOV much smaller than swath.<br>IFOV Very dependent on star avail ability.<br>2 swaths defined:<br>- 1 for high altitude (GOMO_H)<br>- 1 for low altitude (GOMO_L) |
| SCIAMACHY | Nadir /<br>Nadir of Nadir & Limb | SCIAN_                         | POINTING (3 points) | Nadir line         | Continuous Nadir swath modeled  |
|           | Limb /<br>Limb of Nadir & Limb   | SCIALH<br>SCIALL               |                     | Limb wide          | 2 swaths defined:<br>- 1 for high altitude (SCIALH)<br>- 1 for low altitude (SCIALL)  |
| AATSR     |                                  | ATSR_N<br>ATSR_F               | POINTING (3 points) | Nadir line         | 2 swaths defined:<br>- 1 for nadir swath<br>- 1 for forward swath   |
| MWR       |                                  | MWR__                          | POINTING (1 points) | Nadir point        | Modeled as sub-satellite track  |
| MIPAS     | Nominal                          | MIPN_H<br>MIPN_L               | LIMB                | Limb narrow        | 2 swaths defined:<br>- 1 for high altitude (MIPN_H)<br>- 1 for low altitude (MIPN_L)  |
|           | Special Event Mode<br>(across)   | MIP_X_                         | LIMB                | Limb narrow        | Modeled as an across track swath, in the middle of the MIPAS SEM acquisition scan.  |
|           | Special Event Mode<br>(rearward) | MIP_RH<br>MIP_RL               | LIMB                | Limb wide          | IFOV much smaller than swath.<br>2 swaths defined:<br>- 1 for high altitude (MIP_RH)<br>- 1 for low altitude (MIP_RL)   |
|           | Rearward<br><br>Sideward         | MIPIRH<br>MIPIRL<br><br>MIPIXH | INERTIAL            | Inertial direction | 2 swaths defined for rearward mode:<br>- 1 for high altitude (MIPIRH)<br>- 1 for low altitude (MIPIRL)  |

|  |  |        |  |  |
|--|--|--------|--|--|
|  |  | MIPIXL |  | 3 swaths defined for sideward mode:<br>- 1 for high altitude (MIPIXH)<br>- 1 for back mode (MIPIXB)<br>- 1 for forward mode (MIPIXF) |
|--|--|--------|--|--|

### 7.1.3 Zone Borders and Projection

When defining a polygon zone, the user is assumed to wish polygon sides as straight lines. But on the earth surface, a straight line is, at best, a confusing concept.

The only way to define unambiguously straight lines is to work in a 2-dimensional projection of the earth surface. There are many possible projections, each having advantages and drawbacks.

`xv_zone_vis_time` can handle zone borders in 2 different projections:

- rectangular projection, using longitude and latitude as the X and Y axis; this is appropriate to express zones where (some of) the edges follow constant latitude lines, and provide a reasonable approximation for straight lines at low-medium latitudes
- azimuthal gnomonic projection, where great circles are always projected as straight lines; this is better for high latitudes, where the rectangular projection suffers from too much distortion and the singularity at the poles.

`xv_zone_vis_time` allows the user to specify which projection he wants to work in, i.e. in which projection the polygon sides will be represented by `xv_zone_vis_time` as straight lines. The user is assumed to be aware of how the polygon sides behave on the Earth surface.

### 7.1.4 Zone Definition

The user-defined zone can be either (see Table 6);

- a point
- a line
- a polygon
- a circle

A zone is defined by the area of the earth surface enclosed by the zone borders:

- in the case of a circular zone, the area inside the circle
- in the case of a polygonal zone, the area which is always to the right of any polygon side; if the polygon is defined as a sequence of N points, each polygon side is considered as a line from point i to point i+1; this unambiguously defines the right side of the polygon sides.

**Table 6: Zone definition**

| Zone definition | Zone_num | Zone_long<br>Zone_lat | Zone_diam              | Description  |
|-----------------|----------|-----------------------|------------------------|--|
| Circular Zone   | 1        | [0]: centre point     | yes<br>zone_diam > 0.0 | The zone is represented as a circle, around the centre point   |
| Point Zone      | 1        | [0]: Point            | yes<br>zone_diam = 0.0 | The zone is defined by the point. Resulting segments will have a zero duration. The zone will always be completely covered by the swath. |
| Line Zone       | 2        | [0], [1]: Line        | no                     | The zone is defined by the line from point [0] to point [1].   |
| Polygon Zone    | >2       | [i]                   | no                     | The zone is defined by the area right of the line from point [i] to point [i+1].   |

For the gnomonic projection, a side of a zone is always smaller than a half great circle, because two polygon points are considered to be joined by the shortest line.

For the rectangular projection, two consecutive points of the zone are also joined by the shortest line; so the difference in longitude must be less than 180 degrees.

The polygon zone can be closed (i.e. the first and last points are the same) or not. If the zone is not closed, `xv_zone_vis_time` closes it by joining the last point with the first one in its internal computations.

See Figure 6 for examples of zone definitions.

`xv_zone_vis_time` will issue an error on the zone definition if the polygon has intersecting sides (“butterfly” zone).

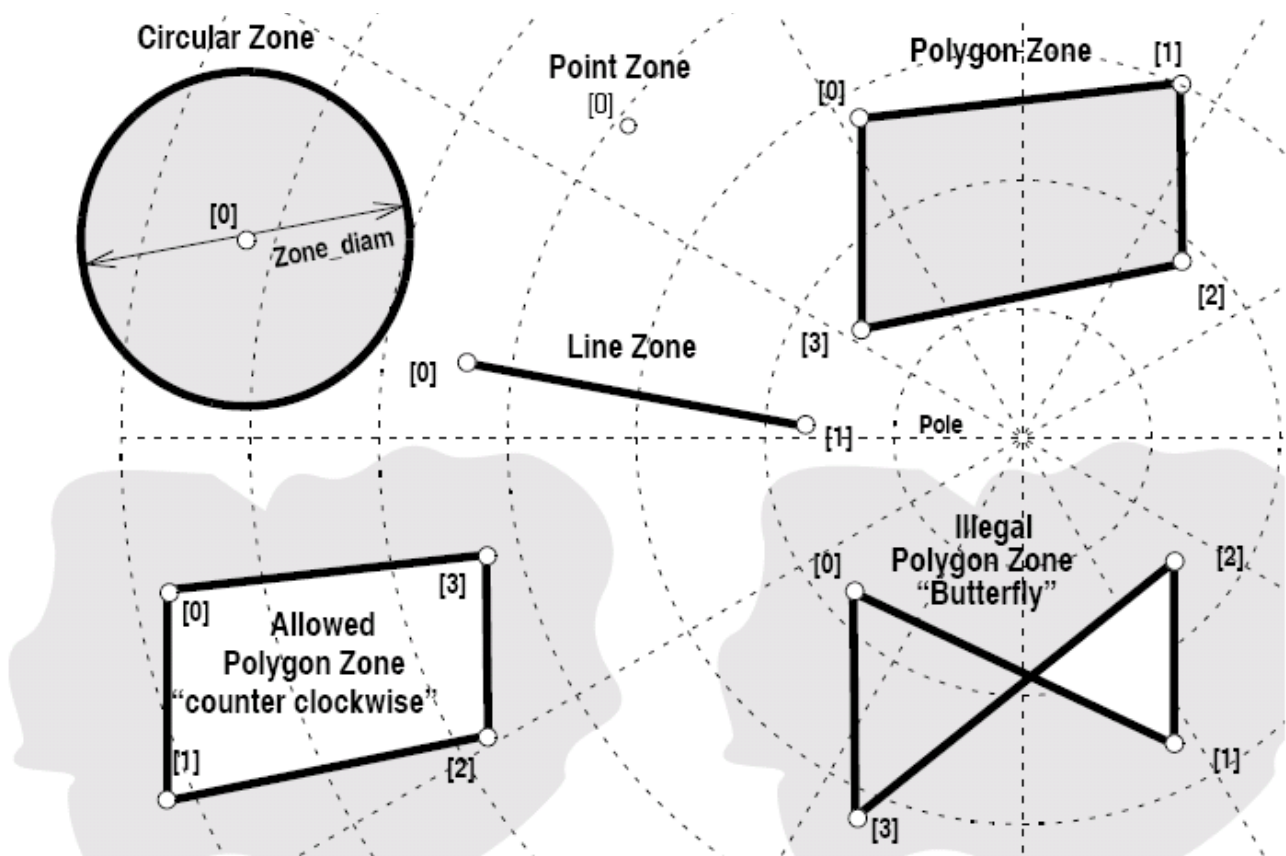

Figure 6: Zone examples

### 7.1.5 Intersection Definition

The `xv_zone_vis_time` intersection times between the instrument swath and the user-defined zone are defined as the first and last occurrence, in chronological order with respect to the satellite direction, of the geometrical super-position of any point belonging to the instrument swath with any single point belonging to the zone (including the zone border).

The entry and exit times for each intersection are given as elapsed seconds (and microseconds) since the ascending node crossing.

Next figure shows some typical intersections.

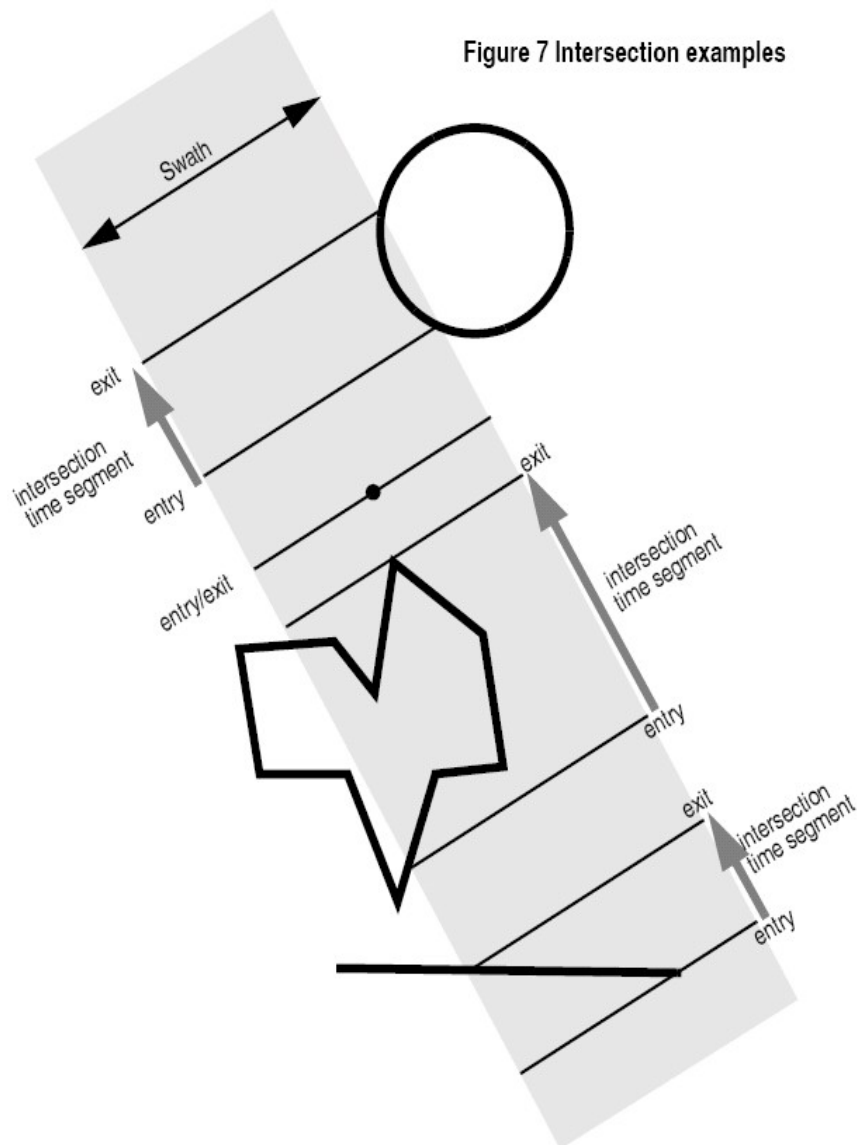

**Figure 7: Intersection examples**

## 7.1.6 Intersection Algorithm

The intersection of a swath and a user-defined zone is to be performed on the Earth projected to a map plane in one of the following projections:

- Rectangular projection
- Gnomonic projection

Although the projections are quite different, the intersection rules are identical. The algorithm can however be different, in order to take advantage of a particular feature of a projection.

The purpose of the CFI function ZONEVISTIME is to obtain quickly, accurate intersection segments with a low precision (1 second).

The algorithms assume that the polygon zones are closed and expects a wrap around between the first and the last point. Thus ZONEVISTIME must first close the polygon if necessary.

For ZONEVISTIME the following swath types are defined:

- point swath: instantaneous swath is a point.
- segment swath: instantaneous swath is a segment.
- multi-segment swath: it can be open or closed.
- inertial swath: not used by ZONEVISTIME

The main concept in the algorithm is the transition, defined as the change in coverage of (part of) the swath and the zone (e.g. edge of the swath crosses one polygon side).

### 7.1.6.1 Intersection with a point swath

The vertices of the polygon defining the area are connected by straight lines in the chosen projection, along track swath points are also connected by straight lines in the same projection.

Transitions are located by linear intersection of the zone sides and the swath along track lines. A transition is only valid if the intersection occurs inside both line segments. The polygon side from  $\langle i \rangle$  to  $\langle j \rangle$  is defined in a clockwise manner inclusive point  $\langle i \rangle$  but exclusive point  $\langle j \rangle$ . The swath line from time  $\langle k \rangle$  to  $\langle l \rangle$  is defined inclusive the template point at  $\langle k \rangle$  but exclusive the template point at  $\langle l \rangle$ .

The fraction of the swath along track line determines the precise timing since time  $\langle k \rangle$  of the intersection. Also the determination if the transition is a on- or off-transition is quite trivial. First a vector is defined, perpendicular to the along track swath line, such that the vector points left. Then, the dot product of the polygon side and this vector is calculated. If the dot product is positive, the transition is on, i.e. the swath enters the zone. If the result is negative, then the swath leaves the zone. If the result equals zero then the transition can be ignored (polygon side and swath overlay, a proper transition will be found with another pair of polygon side - swath line.).

### 7.1.6.2 Intersection with a segment swath

The left and right side of the swath, are located using the same algorithm as for the point swath. Even left and right time segments can be made based on the left and right hand transitions.

The polygon vertices (and not the sides) are intersected with the along track moving line swath, in order to catch zones smaller than the swath, etc. Swaths for intermediate times between two consecutive times in Swath Template File are considered straight segments, joining an intermediate point of the Left swath line from time  $\langle k \rangle$  to time  $\langle l \rangle$ , with an intermediate point in Right swath line.

### 7.1.6.3 Intersection with a multi-segment swath

The algorithm used for segment swath is repeated for every segment of the swath, and the visibility segments obtained in each case are merged with the ones of the other swath segments.

For a closed swath further calculations are done: it is checked if the zone is completely inside the swath area in the interval between contiguous visibility segments, or between the beginning of the first orbit and the first visibility segment, or between the last visibility segment and the end of the last orbit computed. If it is inside, segments must be merged because the zone was visible in the interval.

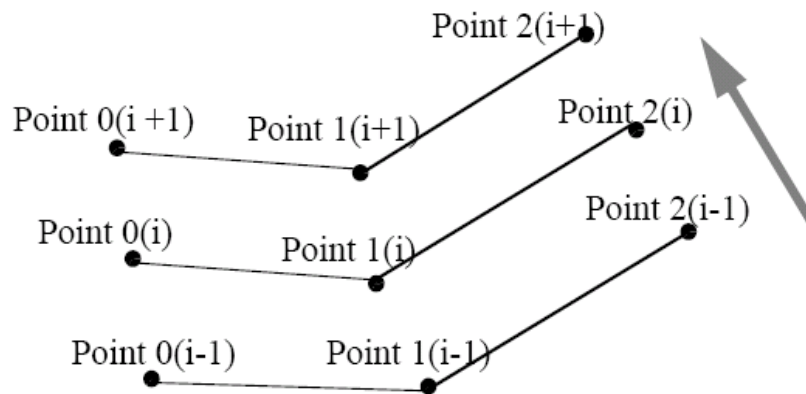

**Figure 8: Swath points**

## 7.1.7 Usage Hints

### 7.1.7.1 Limb-sounding Instruments Intersection

In the case of limb-sounding instrument with a potentially wide azimuth field of view, 2 swaths have to be considered (1 for minimum altitude, 1 for maximum altitude). Furthermore, these 2 swaths are offset in time (i.e. their projection on the earth intersect with a given point at different times). To cope with this, the user must do the following:

- call `xv_zone_vis_time` twice (once for each extreme altitude swath)
- merge/filter the 2 sets of time segments, depending on what he wants to achieve

### 7.1.7.2 Zone Coverage

`xv_zone_vis_time` computes purely geometrical intersections. The resulting zone visibility segments might need some additional filtering by the user. In particular, instrument constraints (e.g. only working outside of sun eclipse) have to be considered by the user.

Furthermore, to help users to deal with zones wider than the swath (i.e. requiring several orbits to cover the whole zone), `xv_zone_vis_time` produces for each zone visibility segment an indication of the coverage type (see Figure 9);

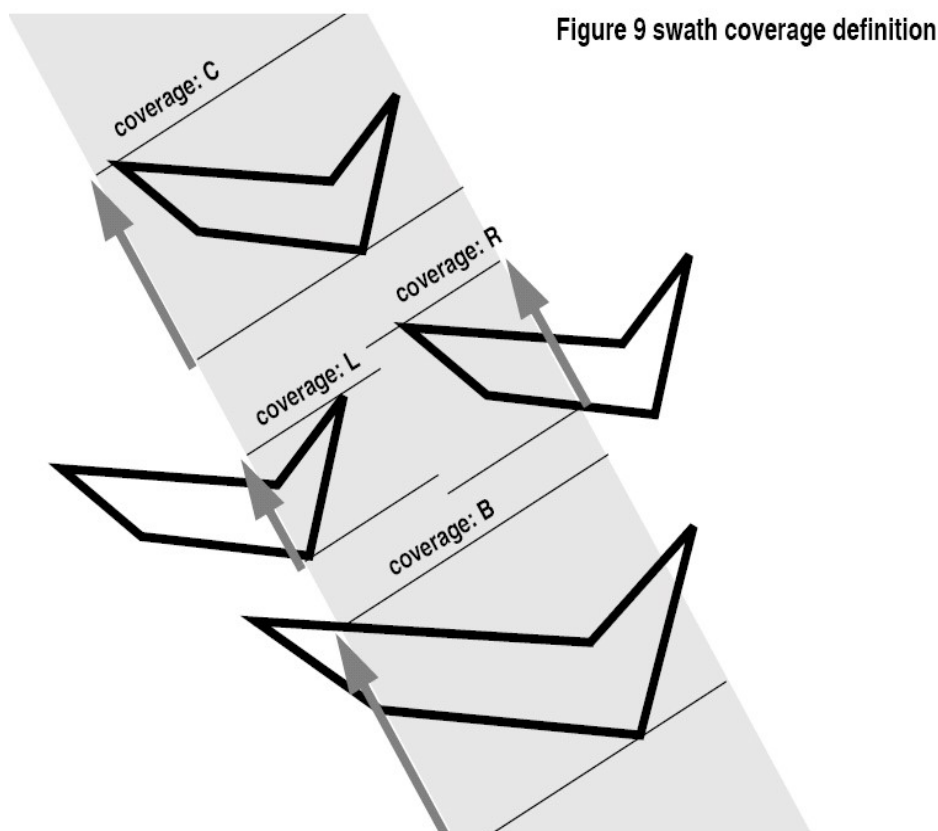

Figure 9: Swath coverage definition



- coverage = C: zone completely covered by the swath
- coverage = R: zone partially covered by the swath, extending over the right edge of the swath
- coverage = L: zone partially covered by the swath, extending over the left edge of the swath
- coverage = B: zone partially covered by the swath, extending over both edges of the swath

### **7.1.7.3 Combined use of xv\_swath\_pos and the coverage flag**

The EO\_VISIBILITY function xv\_swath\_pos can be used to refine the work performed with xv\_zone\_vis\_time.

## 7.1.8 Calling sequence

For C programs, the call to `xv_zone_vis_time` is (input parameters are underlined):

```
#include "explorer_visibility.h"
{
    xo_orbit_id orbit_id = {NULL};
    long    swath_flag, orbit_type,
           start_orbit, start_cycle,
           stop_orbit, stop_cycle,
           zone_num, projection,
           number_segments,
           *bgn_orbit, *bgn_second,
           *bgn_microsec, *bgn_cycle,
           *end_orbit, *end_second,
           *end_microsec, *end_cycle,
           *coverage, ierr[XV_NUM_ERR_ZONE_VIS_TIME],
           status;
    double *zone_long, *zone_lat,
           zone_diam, min_duration;
    char    *swath_file;
    char    *zone_id, *zone_db_file;

    status = xv_zone_vis_time(&orbit_id,
                             &orbit_type,
                             &start_orbit, &start_cycle,
                             &stop_orbit, &stop_cycle,
                             &swath_flag, swath_file,
                             &zone_id, &zone_db_file,
                             &projection, &zone_num,
                             &zone_long, &zone_lat, &zone_diam,
                             &min_duration,
                             &number_segments,
                             &bgn_orbit, &bgn_second,
                             &bgn_microsec, &bgn_cycle,
                             &end_orbit, &end_second,
                             &end_microsec, &end_cycle,
                             &coverage, ierr);
}
```

```
/* Or, using the run_id */  
long run_id;  
  
status = xv_zone_vis_time_run(&run_id,  
                             &orbit_type,  
                             &start_orbit, &start_cycle,  
                             &stop_orbit, &stop_cycle,  
                             &swath_flag, swath_file,  
                             zone_id, zone_db_file,  
                             &projection, &zone_num,  
                             zone_long, zone_lat, &zone_diam,  
                             &min_duration,  
                             &number_segments,  
                             &bgn_orbit, &bgn_second,  
                             &bgn_microsec, &bgn_cycle,  
                             &end_orbit, &end_second,  
                             &end_microsec, &end_cycle,  
                             &coverage, ierr);  
}
```

## 7.1.9 Input parameters

The `xv_zone_vis_time` CFI function has the following input parameters:

**Table 7: Input parameters of `xv_zone_vis_time` function**

| C name                   | C type                    | Array Element | Description (Reference)   | Unit (Format)                     | Allowed Range  |
|--------------------------|---------------------------|---------------|---|-----------------------------------|--|
| <code>orbit_id</code>    | <code>xo_orbit_id*</code> | -             | Structure that contains the orbit data  | -                                 | -  |
| <code>orbit_type</code>  | <code>long*</code>        | -             | Define the type of orbit representation, i.e. absolute or relative orbits in the input/output parameters.<br><br>Relative orbits only can be used when the <code>orbit_id</code> was initialized with orbital changes (with <code>xo_orbit_init_def</code> or with <code>xo_orbit_init_file</code> plus an OSF file). In other cases, only the value <code>XV_ORBIT_ABS</code> can be used.   | -                                 | Complete.  |
| <code>start_orbit</code> | <code>long</code>         | -             | First orbit, segment filter.<br><br>Segments will be filtered as from the beginning of first orbit.<br><br>First Orbit for the orbit initialization will be used when: <ul style="list-style-type: none"> <li>Absolute orbit is set to zero.</li> <li>Relative orbit and cycle number set to zero.</li> </ul>   | absolute or relative orbit number | = 0<br>or:<br><ul style="list-style-type: none"> <li>absolute orbits <math>\geq</math> <code>start_osf</code></li> <li>relative orbits <math>\leq</math> repeat cycle</li> </ul> |
| <code>start_cycle</code> | <code>long</code>         | -             | Cycle number corresponding to the <code>start_orbit</code> . Dummy when using absolute orbits   | cycle number                      | = 0 or<br>$\geq$ first cycle in osf  |
| <code>stop_orbit</code>  | <code>long</code>         | -             | Last orbit, segment filter.<br><br>For <code>orbit_id</code> initialized with orbital changes, when: <ul style="list-style-type: none"> <li><code>stop_orbit = 0</code> (for <code>orbit_type = XV_ORBIT_ABS</code>)</li> </ul> or <ul style="list-style-type: none"> <li><code>stop_orbit = 0</code> and <code>stop_cycle = 0</code> (for <code>orbit_type = XV_ORBIT_REL</code>)</li> </ul> the <code>stop_orbit</code> will be set to the minimum value between: <ul style="list-style-type: none"> <li>the last orbit within the orbital</li> </ul> | absolute or relative orbit number | = 0<br>or:<br><ul style="list-style-type: none"> <li>absolute orbits <math>\geq</math> <code>start_osf</code></li> <li>relative orbits <math>\leq</math> repeat cycle</li> </ul> |

|              |         |     |  |              |                                 |
|--------------|---------|-----|--|--------------|---------------------------------|
|              |         |     | change of the start_orbit.<br><ul style="list-style-type: none"> <li>start_orbit+cycle_length-1 (i.e. the input orbit range will be a complete cycle)</li> </ul>   |              |                                 |
| stop_cycle   | long    | -   | Cycle number corresponding to the stop_orbit. Dummy when using absolute orbits   | cycle number | = 0 or<br>≥ first cycle in osf  |
| swath_flag   | long*   | -   | Define the use of the swath file:<br><ul style="list-style-type: none"> <li>0 = (XV_STF) if the swath file is a swath template file.</li> <li>&gt; 0 if the swath files is a swath definition file. In this case the swath points are generated for every "swath_flag" orbits</li> </ul> | -            | XV_STF = 0<br>XV_SDF = 1<br>> 0 |
| swath_file   | char *  | -   | File name of the swath-file for the appropriate instrument mode  |              |                                 |
| zone_id      | char*   |     | Identification of the zone, as defined in zone_db_file.<br><br>This parameter is used ONLY IF zone_num = 0   |              |                                 |
| zone_db_file | char *  |     | File name of the zone-database-file.<br><br>This file is used ONLY IF zone_num = 0   |              |                                 |
| projection   | long    |     | projection used to define polygon sides as straight lines:<br>= 0 Read projection from Zones DB<br>= 1 Azimuthal gnomonic<br>= 2 Rectangular lat/long  |              |                                 |
| zone_num     | long    |     | Number of vertices of the zone provided in zone_long, zone_lat:<br>= 0 no vertices provided, use zone_id / zone_db_file<br>= 1 Point / Circular zone,<br>= 2 Line zone<br>> 2 Polygon zone   |              | ≥ 0                             |
| zone_long    | double* | all | zone_long[i-1]<br>Geocentric longitude of<br>- circle centre, for circ. zone, i = 1<br>- point, for point zone, i = 1<br>- line-end, for line zone, i = 1 or 2   |              |                                 |

|              |         |     |   |   |       |
|--------------|---------|-----|---|---|-------|
|              |         |     | - vertices, for polygon zone,<br>i = 1... zone_num  |   |       |
| zone_lat     | double* | all | zone_lat[i-1]<br>Geodetic latitude of<br>- circle centre, for circ. zone, i =1<br>- point, for point zone, i = 1<br>- line-end, for line zone, i = 1 or 2<br>- vertices, for polygon zone,<br>i = 1... zone_num |   |       |
| zone_diam    | double  |     | Zone diameter for circular zones,<br>dummy for other zones<br>If diameter equals 0.0 then zone is<br>Point Zone   | m | ≥ 0.0 |
| min_duration | double  |     | Minimum duration for segments.<br>Only segments with a duration<br>longer than min_duration will be<br>given on output.   | s | ≥ 0   |

It is also possible to use enumeration values rather than integer values for some of the input arguments, as shown in the table below:

| Input                                   | Description                            | Enumeration value | long |
|---|--|-------------------|------|
| projection<br>(defined in<br>[D_H_SUM]) | Read projection from the zones DB file | XD_READ_DB        | 0    |
|   | Azimuthal Gnomonic                     | XD_GNOMONIC       | 1    |
|   | Rectangular long/lat                   | XD_RECTANGULAR    | 2    |

## 7.1.10 Output parameters

The output parameters of the `xv_zone_vis_time` CFI function are:

**Table 8: Output parameters of `xv_zone_vis_time` function**

| C name                        | C type | Array Element | Description (Reference)   | Unit (Format) | Allowed Range                         |
|-------------------------------|--------|---------------|---|---------------|---------------------------------------|
| <code>xv_zone_vis_time</code> | long   |               | Function status flag,<br>= 0 No error<br>> 0 Warnings, results generated<br>< 0 Error, no results generated   |               |                                       |
| <code>number_segments</code>  | long   |               | Number of visibility segments returned to the user.   |               | $\geq 0$                              |
| <code>bgn_orbit</code>        | long*  | all           | Orbit number,<br>begin of visibility segment <i>i</i><br><code>bgn_orbit[i-1]</code> ,<br><i>i</i> = 1, <code>number_segments</code>                  |               | > 0                                   |
| <code>bgn_second</code>       | long*  | all           | Seconds since ascending node,<br>begin of visibility segment <i>i</i><br><code>bgn_second[i-1]</code> ,<br><i>i</i> = 1, <code>number_segments</code> | s             | $\geq 0$<br>< orbital period          |
| <code>bgn_microsec</code>     | long*  | all           | Micro seconds within second<br>begin of visibility segment <i>i</i><br><code>bgn_microsec[i-1]</code> ,<br><i>i</i> = 1, <code>number_segments</code> | $\mu$ s       | $\geq 0$<br>999999                    |
| <code>bgn_cycle</code>        | long*  | all           | Cycle number,<br>begin of visibility segment <i>i</i><br><code>bgn_orbit[i-1]</code> ,<br><i>i</i> = 1, <code>number_segments</code>                  |               | >0<br>NULL when using absolute orbits |
| <code>end_orbit</code>        | long*  | all           | Orbit number,<br>end of visibility segment <i>i</i><br><code>end_orbit[i-1]</code> ,<br><i>i</i> = 1, <code>number_segments</code>                    |               | > 0                                   |
| <code>end_second</code>       | long*  | all           | Seconds since ascending node,<br>end of visibility segment <i>i</i><br><code>end_second[i-1]</code> ,<br><i>i</i> = 1, <code>number_segments</code>   | s             | $\geq 0$<br>< orbital period          |

|                                |       |     |   |    |                                       |
|--------------------------------|-------|-----|---|----|---------------------------------------|
| end_microsec                   | long* | all | Micro seconds within second end of visibility segment i<br>end_microsec[i-1],<br>i = 1, number_segments   | μs | ≥0<br>999999                          |
| end_cycle                      | long* | all | Cycle number, end of visibility segment i<br>end_orbit[i-1],<br>i = 1, number_segments  |    | >0<br>NULL when using absolute orbits |
| coverage                       | long* | all | Zone coverage flag for segment<br>= 0 Zone completely covered by swath<br>= 1 Zone not completely covered by swath, extending over the left edge of the swath.<br>= 2 Zone not completely covered by swath, extending over the right edge of the swath.<br>= 3 Zone not completely covered by swath, extending over both edges of the swath<br>coverage[i], i = 0,<br>(number_segments-1) |    |                                       |
| ierr[XV_NUM_ERR_ZONE_VIS_TIME] | long  |     | Error status flags  |    |                                       |

It is also possible to use enumeration values rather than integer values for some of the output arguments, as shown in the table below:

| Input    | Description                      | Enumeration value | long |
|----------|----------------------------------|-------------------|------|
| coverage | Zone completely covered by swath | XV_COMPLETE       | 0    |
|          | Left extreme transitions found   | XV_LEFT           | 1    |
|          | Right extreme transitions found  | XV_RIGHT          | 2    |
|          | Both extreme transitions found   | XV_BOTH           | 3    |

**Memory Management:** Note that the output visibility segments arrays are pointers to integers instead of static arrays. The memory for these dynamic arrays is allocated within the **xv\_zone\_vis\_time** function. So the user will only have to declare those pointers but not to allocate memory for them. However, once the function has returned without error, the user will have the responsibility of freeing the memory for those pointers once they are not used.



### 7.1.11 Warnings and errors

Next table lists the possible error messages that can be returned by the `xv_zone_vis_time` CFI function after translating the returned status vector into the equivalent list of error messages by calling the function of the EO\_VISIBILITY software library `xv_get_msg`.

This table also indicates the type of message returned, i.e. either a warning (WARN) or an error (ERR), the cause of such a message and the impact on the performed calculation, mainly on the results vector.

The table is completed by the error code and value. These error codes can be obtained translating the status vector returned by the `xv_zone_vis_time` CFI function by calling the function of the EO\_VISIBILITY software library `xv_get_code`.

**Table 9: Error messages and codes for `xv_zone_vis_time`**

| Error type | Error message  | Cause and impact          | Error Code                                       | Error No |
|------------|--|---------------------------|--|----------|
| ERR        | Input parameter "Number of ZONE points" is wrong.      | Computation not performed | XV_CFI_ZONE_VIS_TIME_NEGATIVE_NUM_ZONE_ERR       | 0        |
| ERR        | Input parameter "Orbit Id" is wrong.                   | Computation not performed | XV_CFI_ZONE_VIS_TIME_ORBIT_STATUS_ERR            | 1        |
| ERR        | Input parameter "orbit_type" is out of range.          | Computation not performed | XV_CFI_ZONE_VIS_TIME_ORBIT_TYPE_ERR              | 2        |
| ERR        | Input parameter "Minimum duration" cannot be negative. | Computation not performed | XV_CFI_ZONE_VIS_TIME_NEGATIVE_MIN_DURATION_ERR   | 3        |
| ERR        | Input parameter "Projection" out of range.             | Computation not performed | XV_CFI_ZONE_VIS_TIME_PROJECTION_OUT_OF_RANGE_ERR | 4        |
| ERR        | Wrong swath_flag value                                 | Computation not performed | XV_CFI_ZONE_VIS_TIME_SWATH_FLAG_ERR              | 5        |
| ERR        | Swath file is not compatible with the orbit file       | Computation not performed | XV_CFI_ZONE_VIS_TIME_WRONG_SWATH_ERR             | 6        |
| ERR        | Could not generate the swath template file             | Computation not performed | XV_CFI_ZONE_VIS_TIME_GENSWATH_ERR                | 7        |
| ERR        | Error generating visibility segments for orbit "%d"    |                           | XV_ZONE_VIS_TIME_IN_ORBIT_ERR                    | 8        |
| ERR        | Error reading Swath Template File.                     | Computation not performed | XV_CFI_ZONE_VIS_TIME_READ_SWATH_FILE_ERR         | 9        |
| ERR        | Swath type not allowed                                 | Computation not performed | XV_CFI_ZONE_VIS_TIME_INCORRECT_SWATH_TYPE_ERR    | 10       |
| ERR        | Cannot allocate memory for                             | Computation not performed | XV_CFI_ZONE_VIS_TIME                             | 11       |

|       |  |   |   |    |
|-------|--|---|---|----|
|       | the Swath Template File  |   | ME_ALLOCATE_SWATH_MEMORY_ERR                  |    |
| ERR   | Input parameter "start_orbit" cannot be negative.  | Computation not performed                             | XV_CFI_ZONE_VIS_TIME_NEGATIVE_START_ORBIT_ERR | 12 |
| ERR   | Error reading OEF/OSF file.  | Computation not performed                             | XV_CFI_ZONE_VIS_TIME_READ_OSF_ERR             | 13 |
| WAR N | "start_orbit" is before the first orbit in "orbit_event_file".   | Computation performed.<br>Message to inform the user. | XV_CFI_ZONE_VIS_TIME_EARLIER_START_ORBIT_WARN | 14 |
| WAR N | "stop_orbit" is after the last orbit in "orbit_event_file".  | Computation performed.<br>Message to inform the user. | XV_CFI_ZONE_VIS_TIME_LATER_STOP_ORBIT_WARN    | 15 |
| ERR   | Input parameter "start_orbit" cannot be greater than "stop_orbit".   | Computation not performed                             | XV_CFI_ZONE_VIS_TIME_WRONG_ORBIT_RANGE_ERR    | 16 |
| ERR   | Error calling "xv_orbitinfo".  | Computation not performed                             | XV_CFI_ZONE_VIS_TIME_ORBITINFO_CALL_ERR       | 17 |
| ERR   | "cycle_length" read from the input "Swath Template File" is not equal to that of any orbits within the orbit range | Computation not performed                             | XV_CFI_ZONE_VIS_TIME_INCONSISTENT_SWATH_ERR   | 18 |
| WAR N | There is at least one orbital change within the requested orbit range.   | Computation performed.<br>Message to inform the user. | XV_CFI_ZONE_VIS_TIME_ORBITAL_CHANGE_WARN      | 19 |
| ERR   | Input parameter "zone_id" is an empty string.  | Computation not performed                             | XV_CFI_ZONE_VIS_TIME_ZONE_ID_EMPTY_ERR        | 20 |
| ERR   | Number of characters in input string "zone_id" is different from %li.  | Computation not performed                             | XV_CFI_ZONE_VIS_TIME_WRONG_ZONE_ID_LENGTH_ERR | 21 |
| ERR   | Error reading the ZONE Database file.  | Computation not performed                             | XV_CFI_ZONE_VIS_TIME_READ_ZONE_DB_FILE_ERR    | 22 |
| WAR N | "Projection" parameter set to default.   | Computation performed.<br>Message to inform the user. | XV_CFI_ZONE_VIS_TIME_DEFAULT_PROJECTION_WARN  | 23 |
| ERR   | Cannot allocate memory for the ZONE records."  | Computation not performed                             | XV_CFI_ZONE_VIS_TIME_ALLOCATE_ZONE_MEMORY_ERR | 24 |
| ERR   | Latitude must be in the range [-90.0 , 90.0].  | Computation not performed                             | XV_CFI_ZONE_VIS_TIME_WRONG_LATITU             | 25 |

|       |   |   | DE_RANGE_ERR                                      |    |
|-------|---|---|---|----|
| WAR N | Two consecutive points are equal, only one is used.   | Computation performed.<br>Message to inform the user. | XV_CFI_ZONE_VIS_TIME_TWO_EQUAL_POINTS_WARN        | 26 |
| ERR   | Difference in longitude for 2 consecutive ZONE points is equal to 180.0 degrees (RECTANGULAR projection). Zone definition is ambiguous. | Computation not performed                             | XV_CFI_ZONE_VIS_TIME_DIFF_LONG_180_ERR            | 27 |
| ERR   | Two consecutive ZONE points are antipodal (GNOMONIC projection). Zone definition is ambiguous.  | Computation not performed                             | XV_CFI_ZONE_VIS_TIME_ANTIPODAL_POINTS_ERR         | 28 |
| ERR   | Error precomputing intersection of two segments.  | Computation not performed                             | XV_CFI_ZONE_VIS_TIME_SEGMENT_INTERSECT_PREC_ERR   | 32 |
| ERR   | Error computing intersection of two segments.   | Computation not performed                             | XV_CFI_ZONE_VIS_TIME_SEGMENT_INTERSECT_COMP_ERR   | 33 |
| ERR   | Error computing gnomonic coordinates.   | Computation not performed                             | XV_CFI_ZONE_VIS_TIME_GNOMONIC_COORD_ERR           | 34 |
| ERR   | Two ZONE segments intersect.  | Computation not performed                             | XV_CFI_ZONE_VIS_TIME_TWO_SEGMENTS_INTERSECT_ERR   | 35 |
| ERR   | Two consecutive ZONE segments are aligned in the same direction.  | Computation not performed                             | XV_CFI_ZONE_VIS_TIME_ALLIGNED_SEGMENTS_ERR        | 36 |
| ERR   | Input parameter "ZONE diameter" cannot be negative (POINT or CIRCLE zone).  | Computation not performed                             | XV_CFI_ZONE_VIS_TIME_ZONE_DIAM_NEGATIVE_ERR       | 37 |
| ERR   | SWATH contains the POLE (RECTANGULAR projection).   | Computation not performed                             | XV_CFI_ZONE_VIS_TIME_POLE_IN_SWATH_ERR            | 38 |
| ERR   | Not convex SWATH quadrilateral for the specified latitude range.  | Computation not performed                             | XV_CFI_ZONE_VIS_TIME_CUADRILATERAL_NOT_CONVEX_ERR | 39 |
| ERR   | Error checking if a point is inside a quadrilateral.  | Computation not performed                             | XV_CFI_ZONE_VIS_TIME_POINT_IN_CUADRILATERAL_ERR   | 40 |
| ERR   | Error sorting intersections.  | Computation not performed                             | XV_CFI_ZONE_VIS_TIME_SORT_INTERSECTIONS_ERR       | 41 |

|       |  |   |   |    |
|-------|--|---|---|----|
| ERR   | Cannot (re)allocate memory for the segments.                       | Computation not performed                             | XV_CFI_ZONE_VIS_T<br>ME_SEGMENTS_M<br>EMORY_ERR                       | 42 |
| ERR   | Too many time segments (more than MAX_ORBITS).                     | Computation not performed                             | XV_CFI_ZONE_VIS_T<br>ME_MAX_ORBITS_ER R                               | 43 |
| ERR   | Cannot allocate memory for the coverage.                           | Computation not performed                             | XV_CFI_ZONE_VIS_T<br>ME_COVERAGE_ME<br>MORY_ERR                       | 44 |
| WAR N | Warning checking the visibility segments.                          | Computation performed.<br>Message to inform the user. | XV_CFI_ZONE_VIS_T<br>ME_CHECK_SEGMEN<br>TS_WARN                       | 45 |
| ERR   | Error checking the visibility segments.                            | Computation not performed                             | XV_CFI_ZONE_VIS_T<br>ME_CHECK_SEGMEN<br>TS_ERR                        | 46 |
| ERR   | Error computing final segments for the POINT swath and POINT zone. | Computation not performed                             | XV_CFI_ZONE_VIS_T<br>ME_ORBIT_TO_TIME_<br>CALL_ERR                    | 47 |
| ERR   | Wrong input Orbit Id. Unknown orbit initialization mode            | Computation not performed                             | XV_CFI_ZONE_VIS_T<br>ME_ORBIT_MODEL_E RR                              | 48 |
| WAR N | "stop_orbit" is after the last orbit in the orbit file.            | Computation performed.<br>Message to inform the user. | XV_CFI_ZONE_VIS_T<br>ME_STOP_ORBIT_WA RN                              | 49 |
| ERR   | Error computing the ANX longitude                                  | Computation not performed                             | XV_CFI_ZONE_VIS_T<br>ME_COMPUTE_ANX_ ERR                              | 50 |
| ERR   | Error calling "orbit info"   | Computation not performed                             | XV_CFI_ZONE_VIS_T<br>ME_ORBIT_INFO_ERR                                | 51 |
| ERR   | Error computing Multi- Point swath visibilities                    | Computation not performed                             | XV_CFI_ZONE_VIS_T<br>ME_MULTI_POINT_S<br>WATH_INTERS_ERR              | 52 |
| ERR   | Error computing Point swath visibilities                           | Computation not performed                             | XV_CFI_ZONE_VIS_T<br>ME_POINT_SWATH_I<br>NTERS_ERR                    | 53 |
| ERR   | Error checking visibility segments                                 | Computation not performed                             | XV_CFI_ZONE_VIS_T<br>ME_ON_OFF_CHECKI<br>NG_ERR                       | 54 |
| ERR   | Error merging visibility segments                                  | Computation not performed                             | XV_CFI_ZONE_VIS_T<br>ME_MERGE_SWATH_<br>SEGMENTS_VISIBILIT<br>IES_ERR | 55 |
| ERR   | Error trying to allocate memory                                    | Computation not performed                             | XV_CFI_ZONE_VIS_T<br>ME_MEMORY_ALLO<br>CATION_ERR                     | 56 |
| ERR   | Error calling "swath_pos"  | Computation not performed                             | XV_CFI_ZONE_VIS_T   | 57 |

|      |   |                           | ME_SWATH_POS_ER R   |    |
|------|---|---------------------------|---|----|
| ERR  | Error calling "Polygon_inner_point"   | Computation not performed | XV_CFI_ZONE_VIS_TI<br>ME_POLYGON_INNE<br>R_POINT_ERR                        | 58 |
| ERR  | Error comparing orbits orbital changes  | Computation not performed | XV_CFI_ZONE_VIS_TI<br>ME_CHECK_ORBITAL_CH<br>ANGE_ERR                       | 59 |
| ERR  | Error converting zone point arrays to zone record   | Computation not performed | XV_CFI_ZONE_VIS_TI<br>ME_CONVERT_ZONE_ER<br>R                               | 64 |
| ERR  | No suitable zone found for orbit interval   | Computation not performed | XV_CFI_ZONE_VIS_TI<br>ME_ZONE_ORBIT_ERR                                     | 65 |
| ERR  | Error cloning zone  | Computation not performed | XV_CFI_ZONE_VIS_TI<br>ME_CLONE_ZONE_ERR                                     | 66 |
| ERR  | Input orbit interval is completely outside STF validity interval                                    | Computation not performed | XV_CFI_ZONE_VIS_TIME_<br>ORBIT_INTERVAL_STF_ER<br>R                         | 67 |
| WARN | Input orbit interval is partially outside STF validity interval                                     | Computation performed     | XV_CFI_ZONE_VIS_TIME_<br>ORBIT_INTERVAL_STF_W<br>ARN                        | 68 |
| ERR  | Input OSF has non-trivial MLST non linear terms but STF was generated without them                  | Computation not performed | XV_CFI_ZONE_VIS_TIME_<br>OSF_NON_LIN_STF_OLD_<br>WARN                       | 69 |
| WARN | Swath flag larger than MLST linear approximation validity. MLST linear approximation validity used. | Computation performed     | XV_CFI_ZONE_VIS_TIME_<br>SWATH_FLAG_LARGER_T<br>HAN_LIN_APPROX_VAL_W<br>ARN | 70 |
| ERR  | Geostationary satellite not allowed for this function.  | Computation not performed | XV_CFI_ZONE_VIS_TIME_<br>GEO_SAT_ERR  | 71 |
| WARN | This function is deprecated. Use xv_zonevistime_compute instead                                     | Computation performed     | XV_CFI_ZONE_VIS_TIME_<br>DEPRECATED_WARN                                    | 72 |
| WARN | Visibility computations with precise propagator can be very slow                                    | Computation performed     | XV_CFI_ZONE_VIS_TIME_<br>PRECISE_PROPAG_WARN                                | 73 |

Note that error codes and messages have been completely modified since the last issue due to a completely new implementation of the CFI function.

## 7.2 xv\_zone\_vis\_time\_no\_file

### 7.2.1 Overview

**Note:** this function is deprecated. Use `xv_zonevistime_compute` instead.

The `xv_zone_vis_time_no_file` function computes all the orbital segments for which a given instrument swath intercepts a user-defined zone at the surface of the Earth ellipsoid.

The aim of this function is to provide another interface for the function `xv_zone_vis_time` in which the zone and the swath are not provided with files but with the data structures (see section 7.2.2).

Information about zones, swaths and intersection algorithms can be found in section 7.1.

### 7.2.2 Calling sequence

For C programs, the call to `xv_zone_vis_time_no_file` is (input parameters are underlined):

```
#include "explorer_visibility.h"
{
    xo_orbit_id orbit_id = {NULL};
    long    orbit_type,
           start_orbit, start_cycle,
           stop_orbit, stop_cycle,
           zone_num, projection,
           number_segments,
           *bgn_orbit, *bgn_second,
           *bgn_microsec, *bgn_cycle,
           *end_orbit, *end_second,
           *end_microsec, *end_cycle,
           *coverage, ierr[XV_NUM_ERR_ZONE_VIS_TIME],
           status;
    double *zone_long, *zone_lat,
           zone_diam, min_duration;
    xd_stf_file stf_data;
    xd_zone_rec zone_data;

    status = xv_zone_vis_time_no_file(&orbit_id,
                                     &orbit_type,
                                     &start_orbit, &start_cycle,
                                     &stop_orbit, &stop_cycle,
                                     &stf_data,
                                     &zone_data,
                                     &projection, &zone_num,
```

```
zone_long, zone_lat, &zone_diam,  
&min_duration,  
number_segments,  
&bgn_orbit, &bgn_second,  
&bgn_microsec, &bgn_cycle,  
&end_orbit, &end_second,  
&end_microsec, &end_cycle,  
&coverage, ierr);  
  
/* Or, using the run_id */  
long run_id;  
  
status = xv_zone_vis_time_no_file_run(&run_id,  
orbit_type,  
&start_orbit, &start_cycle,  
&stop_orbit, &stop_cycle,  
&stf_data,  
&zone_data,  
&projection, &zone_num,  
zone_long, zone_lat, &zone_diam,  
&min_duration,  
number_segments,  
&bgn_orbit, &bgn_second,  
&bgn_microsec, &bgn_cycle,  
&end_orbit, &end_second,  
&end_microsec, &end_cycle,  
&coverage, ierr);  
}
```

### 7.2.3 Input parameters

The `xv_zone_vis_time_no_file` CFI function has the following input parameters:

**Table 10: Input parameters of `xv_zone_vis_time_no_file` function**

| C name                     | C type                    | Array Element | Description (Reference)   | Unit (Format)                     | Allowed Range  |
|----------------------------|---------------------------|---------------|---|-----------------------------------|--|
| <code>orbit_id</code>      | <code>xo_orbit_id*</code> | -             | Structure that contains the orbit data  | -                                 | -  |
| <code>orbit_type</code>    | <code>long*</code>        | -             | Define the type of orbit representation, i.e. absolute or relative orbits in the input/output parameters.<br><br>Relative orbits only can be used when the <code>orbit_id</code> was initialized with orbital changes (with <code>xo_orbit_init_def</code> or with <code>xo_orbit_init_file</code> plus an OSF file). In other cases, only the value <code>XV_ORBIT_ABS</code> can be used.   | -                                 | Complete.  |
| <code>start_orbit</code>   | <code>long</code>         | -             | First orbit, segment filter.<br><br>Segments will be filtered as from the beginning of first orbit.<br><br>First Orbit for the orbit initialization will be used when: <ul style="list-style-type: none"> <li>Absolute orbit is set to zero.</li> <li>Relative orbit and cycle number set to zero.</li> </ul>   | absolute or relative orbit number | = 0<br>or:<br><ul style="list-style-type: none"> <li>absolute orbits <math>\geq \text{start\_osf}</math></li> <li>relative orbits <math>\leq \text{repeat cycle}</math></li> </ul> |
| • <code>start_cycle</code> | <code>long</code>         | -             | Cycle number corresponding to the <code>start_orbit</code> . Dummy when using absolute orbits   | cycle number                      | = 0 or $\geq \text{first cycle in osf}$  |
| <code>stop_orbit</code>    | <code>long</code>         | -             | Last orbit, segment filter.<br><br>For <code>orbit_id</code> initialized with orbital changes, when: <ul style="list-style-type: none"> <li><code>stop_orbit = 0</code> (for <code>orbit_type = XV_ORBIT_ABS</code>)</li> </ul> or <ul style="list-style-type: none"> <li><code>stop_orbit = 0</code> and <code>stop_cycle = 0</code> (for <code>orbit_type = XV_ORBIT_REL</code>)</li> </ul> the <code>stop_orbit</code> will be set to the minimum value between: <ul style="list-style-type: none"> <li>the last orbit within the orbital</li> </ul> | absolute or relative orbit number | = 0<br>or:<br><ul style="list-style-type: none"> <li>absolute orbits <math>\geq \text{start\_osf}</math></li> <li>relative orbits <math>\leq \text{repeat cycle}</math></li> </ul> |



|            |              |     |   |              |                                |
|------------|--------------|-----|---|--------------|--------------------------------|
|            |              |     | <p>change of the start_orbit.</p> <ul style="list-style-type: none"> <li>start_orbit+cycle_length-1 (i.e. the input orbit range will be a complete cycle)</li> </ul> <p>If it is not initialized with orbital changes, stop orbit will be set to the last orbit in orbit_id initialization.</p>                         |              |                                |
| stop_cycle | long         | -   | Cycle number corresponding to the stop_orbit. Dummy when using absolute orbits  | cycle number | = 0 or<br>≥ first cycle in osf |
| sff_data   | xd_stf_file  | -   | <p>Swath template data (structure described in [D_H_SUM]).</p> <p>The swath structure can be got by:</p> <ul style="list-style-type: none"> <li>Reading a swath template file with the CFI function <b>xd_read_stf</b>.</li> <li>Generating the swath data with the CFI function <b>xv_gen_swath_no_file</b></li> </ul> | -            | -                              |
| zone_data  | xd_zone_read | -   | Zone data (structure described in [D_H_SUM]) that can be got by reading a zone from a zone database file with the CFI function <b>xd_read_zone</b> .  | -            | -                              |
| projection | long         |     | <p>projection used to define polygon sides as straight lines:</p> <p>= 0 Read projection from Zones DB</p> <p>= 1 Azimuthal gnomonic</p> <p>= 2 Rectangular lat/long</p>  | -            | -                              |
| zone_num   | long         |     | <p>Number of vertices of the zone provided in zone_long, zone_lat:</p> <p>= 0 no vertices provided, use zone_id / zone_db_file</p> <p>= 1 Point / Circular zone,</p> <p>= 2 Line zone</p> <p>&gt; 2 Polygon zone</p>  |              | ≥ 0                            |
| zone_long  | double*      | all | <p>zone_long[i-1]</p> <p>Geocentric longitude of</p> <p>- circle centre, for circ. zone, i =1</p> <p>- point, for point zone, i = 1</p>   |              |                                |

|              |         |     |   |   |       |
|--------------|---------|-----|---|---|-------|
|              |         |     | - line-end, for line zone, i = 1 or 2<br>- vertices, for polygon zone,<br>i = 1... zone_num   |   |       |
| zone_lat     | double* | all | zone_lat[i-1]<br>Geodetic latitude of<br>- circle centre, for circ. zone, i =1<br>- point, for point zone, i = 1<br>- line-end, for line zone, i = 1 or 2<br>- vertices, for polygon zone,<br>i = 1... zone_num |   |       |
| zone_diam    | double  |     | Zone diameter for circular zones,<br>dummy for other zones<br>If diameter equals 0.0 then zone is<br>Point Zone   | m | ≥ 0.0 |
| min_duration | double  |     | Minimum duration for segments.<br>Only segments with a duration<br>longer than min_duration will be<br>given on output.   | s | ≥ 0   |

It is also possible to use enumeration values rather than integer values for some of the input arguments, as shown in the table below:

| Input                                   | Description                            | Enumeration value | long |
|---|--|-------------------|------|
| projection<br>(defined in<br>[D_H_SUM]) | Read projection from the zones DB file | XD_READ_DB        | 0    |
|   | Azimuthal Gnomonic                     | XD_GNOMONIC       | 1    |
|   | Rectangular long/lat                   | XD_RECTANGULAR    | 2    |

## 7.2.4 Output parameters

The output parameters of the `xv_zone_vis_time_no_file` CFI function are:

**Table 11: Output parameters of `xv_zone_vis_time_no_file` function**

| C name                                | C type | Array Element | Description (Reference)   | Unit (Format) | Allowed Range                          |
|---------------------------------------|--------|---------------|---|---------------|--|
| <code>xv_zone_vis_time_no_file</code> | long   |               | Function status flag,<br>= 0 No error<br>> 0 Warnings, results generated<br>< 0 Error, no results generated   |               |  |
| <code>number_segments</code>          | long   |               | Number of visibility segments returned to the user.   |               | $\geq 0$                               |
| <code>bgn_orbit</code>                | long*  | all           | Orbit number,<br>begin of visibility segment <i>i</i><br><code>bgn_orbit[i-1]</code> ,<br><i>i</i> = 1, <code>number_segments</code>                  |               | > 0                                    |
| <code>bgn_second</code>               | long*  | all           | Seconds since ascending node,<br>begin of visibility segment <i>i</i><br><code>bgn_second[i-1]</code> ,<br><i>i</i> = 1, <code>number_segments</code> | s             | $\geq 0$<br>< orbital period           |
| <code>bgn_microsec</code>             | long*  | all           | Micro seconds within second<br>begin of visibility segment <i>i</i><br><code>bgn_microsec[i-1]</code> ,<br><i>i</i> = 1, <code>number_segments</code> | $\mu$ s       | $\geq 0$<br>999999                     |
| <code>bgn_cycle</code>                | long*  | all           | Cycle number,<br>begin of visibility segment <i>i</i><br><code>bgn_orbit[i-1]</code> ,<br><i>i</i> = 1, <code>number_segments</code>                  |               | > 0<br>NULL when using absolute orbits |
| <code>end_orbit</code>                | long*  | all           | Orbit number,<br>end of visibility segment <i>i</i><br><code>end_orbit[i-1]</code> ,<br><i>i</i> = 1, <code>number_segments</code>                    |               | > 0                                    |
| <code>end_second</code>               | long*  | all           | Seconds since ascending node,<br>end of visibility segment <i>i</i><br><code>end_second[i-1]</code> ,<br><i>i</i> = 1, <code>number_segments</code>   | s             | $\geq 0$<br>< orbital period           |

|                                    |       |     |  |    |  |
|------------------------------------|-------|-----|--|----|--|
| end_microsec                       | long* | all | Micro seconds within second<br>end of visibility segment i<br>end_microsec[i-1],<br>i = 1, number_segments   | μs | ≥ 0<br>999999                            |
| end_cycle                          | long* | all | Cycle number,<br>end of visibility segment i<br>end_orbit[i-1],<br>i = 1, number_segments  |    | >0<br>NULL when using<br>absolute orbits |
| coverage                           | long* | all | Zone coverage flag for segment<br>= 0 Zone completely covered by<br>swath<br>= 1 Zone not completely covered<br>by swath, extending over the left<br>edge of the swath.<br>= 2 Zone not completely covered<br>by swath, extending over the right<br>edge of the swath.<br>= 3 Zone not completely covered<br>by swath, extending over both<br>edges of the swath<br>coverage[i], i = 0,<br>(number_segments-1) |    |  |
| ierr[XV_NUM_ERR_Z<br>ONE_VIS_TIME] | long  |     | Error status flags   |    |  |

It is also possible to use enumeration values rather than integer values for some of the output arguments, as shown in the table below:

| Input    | Description                      | Enumeration value | long |
|----------|----------------------------------|-------------------|------|
| coverage | Zone completely covered by swath | XV_COMPLETE       | 0    |
|          | Left extreme transitions found   | XV_LEFT           | 1    |
|          | Right extreme transitions found  | XV_RIGHT          | 2    |
|          | Both extreme transitions found   | XV_BOTH           | 3    |

**Memory Management:** Note that the output visibility segments arrays are pointers to integers instead of static arrays. The memory for these dynamic arrays is allocated within the `xv_zone_vis_time_no_file` function. So the user will only have to declare those pointers but not to allocate memory for them. However, once the function has returned without error, the user will have the responsibility of freeing the memory for those pointers once they are not used.

### **7.2.5 Warnings and errors**

The error and warning messages and codes for `xv_zone_vis_time_no_file` are the same than for `xv_zone_vis_time` (see Table 9) .

The error messages/codes can be returned by the CFI function `xv_get_msg/xv_get_code` after translating the returned status vector into the equivalent list of error messages/codes. The function identifier to be used in that functions is `XV_ZONE_VIS_TIME_ID` (from Table 2).

## 7.3 xv\_zonevistime\_compute

### 7.3.1 Overview

The `xv_zonevistime_compute` function computes all the orbital segments for which a given instrument swath intercepts a one or more user-defined zones at the surface of the Earth ellipsoid.

An orbital segment is a time interval along the orbit, defined by start and stop times expressed as seconds (and microseconds) elapsed since the ascending node crossing.

A user-defined zone can be:

- a polygon specified by a set of latitude and longitude points
- a circle specified by the centre latitude, longitude, and the diameter

Note that particular cases of the above can be used to define the zone as:

- a point
- a line

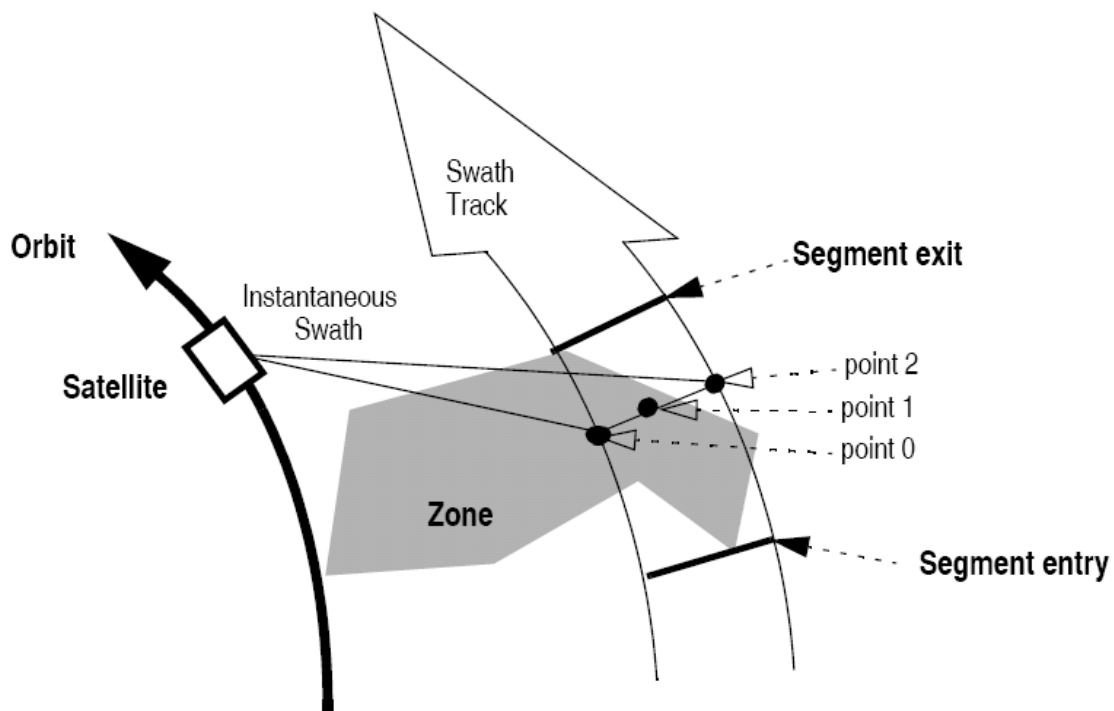

Figure 10: Segment Definition `xv_zonevistime_compute`

If more than one zone is used as input, the visibilities are internally computed for each zone, and the segments are merged and ordered by start time. In the output visibility list, the zones where the segment has visibility are provided, and also the coverage of the segment for each zone (see Figure 11).

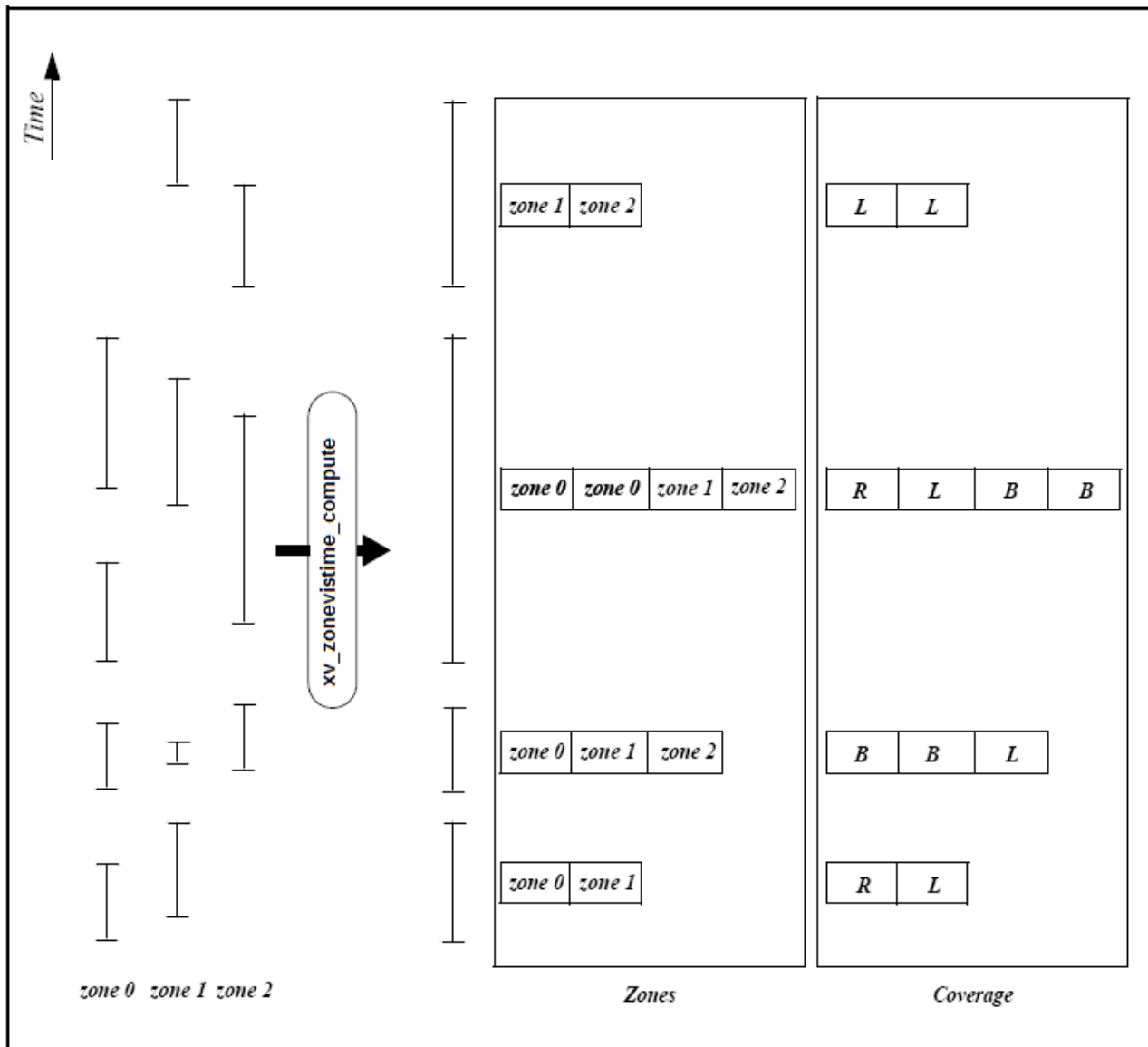

Figure 11: `xv_zonevistime_compute` function (more than one zone)

`xv_zonevistime_compute` requires access to several data structures and files to produce its results:

- the `orbit_id` (`xo_orbit_id`) providing the orbital data. The `orbit_id` can be initialized with the following data or files, also with precise propagator initialization if applicable (see [ORBIT\_SUM]):
  - data for an orbital change
  - Orbit scenario files
  - Predicted orbit files
  - Orbit Event Files (**Note: Orbit Event File is deprecated, only supported for CRYOSAT mission**).
  - Restituted orbit files
  - DORIS Preliminary orbit files
  - DORIS Navigator files
  - TLE files

Note: if the orbit is initialized for precise propagation, the execution of the visibility function can be very slow. As alternative, a POF can be generated with the precise propagator (function `xo_gen_pof`) for the range of orbits the user usually needs, and use this generated file to initialize the orbit id. The execution time performance will be much better for the visibility function and it will not have a big impact on the precision of the calculations.

- the `swath_id` (`xv_swath_id`, initialized using `xv_swath_id_init` -section 7.32-) providing the Instrument Swath information, excluding inertial swath files, describing the area seen by the relevant instrument all along the current orbit. If the `swath_id` is initialized with a Swath definition file or Swath definition data, `xv_zonevistime_compute` generates the swath points for a number of orbits given by the user.
- The information of the zone or zones (`xv_zone_info_list`).

The time intervals (`xv_time_interval`) used by `xv_zonevistime_compute` can be expressed as UTC times or orbit times (orbit plus seconds and microseconds since ascending node). This intervals express the start time/orbit and last time/orbit for the computations.

In case the time intervals are expressed as orbits, they can be expressed as absolute orbit numbers or in relative orbit and cycle numbers.

The orbit representation (absolute or relative) for the output segments will be the same as in the input orbits. The output segments will contain UTC times and orbit times. Moreover, the segments will be ordered chronologically.

**NOTE:** If `xv_zonevistime_compute` is used with a range of orbits that includes an orbital change (e.g. change in the repeat cycle or cycle length), [the behavior depends on the type of the data used to initialize the `swath\_id` \(via `xv\_swath\_id\_init`, section 7.32\):](#)

•If a **swath template file** is used, `xv_zonevistime_compute` automatically will ignore the orbits that do not correspond with the template file (i.e. no visibility segments will be generated for those orbits), since swath template file is generated from a reference orbit with a particular geometry, so it is not valid for a different geometry.

•If a **swath definition file** is introduced, `xv_zonevistime_compute` will perform the computations across orbital changes, and will return the visibility segments corresponding to the whole orbital range. Internally, swath template files valid for every orbital change are generated to perform the calculations.

**NOTE 2:**If a swath template file with the variable header tags *Start\_VValidity\_Range* and *Stop\_VValidity\_Range* is used as input, only the segments belonging to that orbit range will be returned.

**NOTE 3:** If a swath definition file is introduced, it can be also introduced every how many orbits the swath template file must be recomputed (the number of orbit for regeneration is introduced in `swath_id` initialization). If the `orbit_id` has been initialized with an OSF file with MLST non linear terms and the number of orbits for regeneration is greater than the linear approximation validity, the recomputation of swath template file will be done every linear approximation validity orbits.



### **7.3.2 Swath Definition**

The swath file that can be used to initialize the swath id is generated using the `xv_gen_swath` function, within the `EO_VISIBILITY` library. There are 3 different types of swaths:

- earth-observing instruments ('nadir curve', 'nadir point' or "area swaths")
- limb-sounding instruments ('limb', narrow or wide)
- limb-sounding instruments observing inertial objects ('inertial')

The following sub-sections provide some details on the various swath definitions.

#### **7.3.2.1 Earth-observing Instruments Swath Definition**

The term swath must be clearly defined to understand the explanations in this document:

- instantaneous swath: the part of the earth surface observed by an instrument at a given time
- swath track: represents the track made on the earth surface by the instantaneous swath over a period of time

For instruments observing the surface of the earth, the instantaneous swath is constituted by the point/curve/area on the ground observed by the instrument at a given time. It is calculated taking the earth ellipsoid as a reference for the earth surface. The wider the field-of-view of the instrument, the wider the swath on the ground.

When the satellite moves over a period of time, this point/curve/area defines a band on the earth surface. This constitutes the swath track.

See next figure for an illustration of these definitions.

Note that the terms curve or point are an idealized view of the instrument FOV, which usually have a thickness.

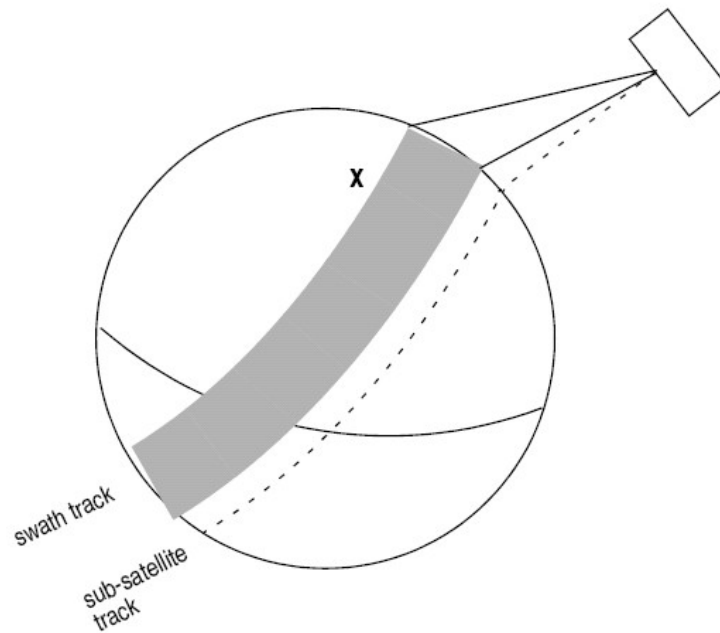

**Figure 12: Earth-observing instrument: swath definition**

### 7.3.2.2 Limb-sounding Instruments Swath Definition

For limb sounding instruments, the concept can be generalized to define a “thick swath”. This is obtained by defining a minimum and a maximum altitude, and considering the tangent points to these altitudes as the edges of the swath. Two cases have to be considered:

- deterministic (narrow) azimuth field of view (e.g. MIPAS sideward-looking): the swath projection on the earth surface is similar to a regular sideward-looking swath, with the lower altitude defining the further swath edge and the higher altitude defining the closer swath edge. See Figure 13.
- non-deterministic (potentially wide) azimuth field of view (e.g. MIPAS rearward-looking): due to the potentially wide azimuth field of view, each altitude defines a swath projection on the earth surface. Depending on the altitude, these swaths are of different width across-track, and also at different distance from the satellite. See Figure 14.

For these, 2 Instrument Swath Files are provided:

- one at the highest altitude
- one at the lowest altitude

The user must handle both swath himself to determine his required visibility time segments

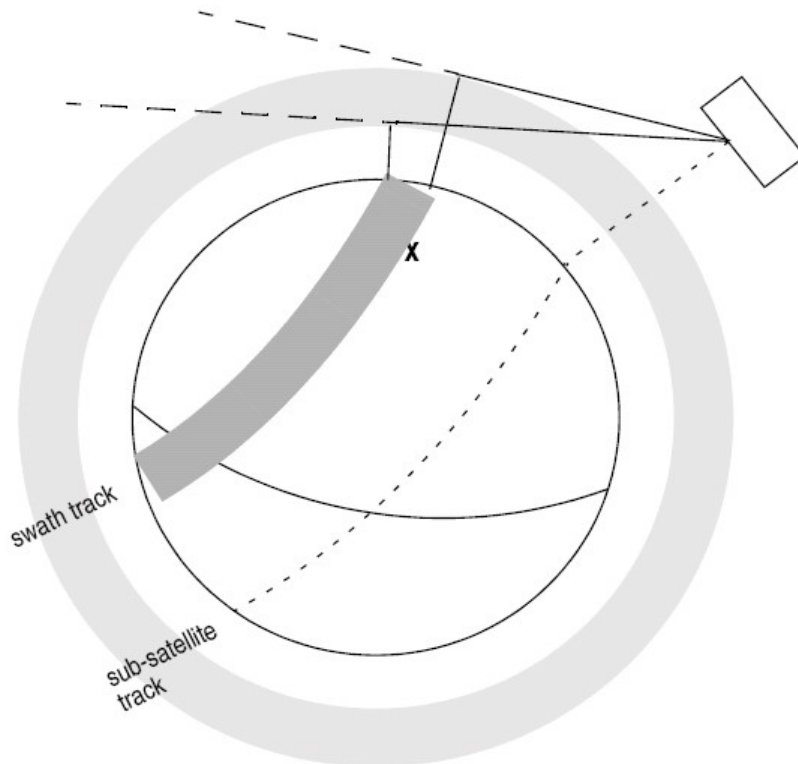

**Figure 13: Limb-sounding instrument: swath definition (1)**

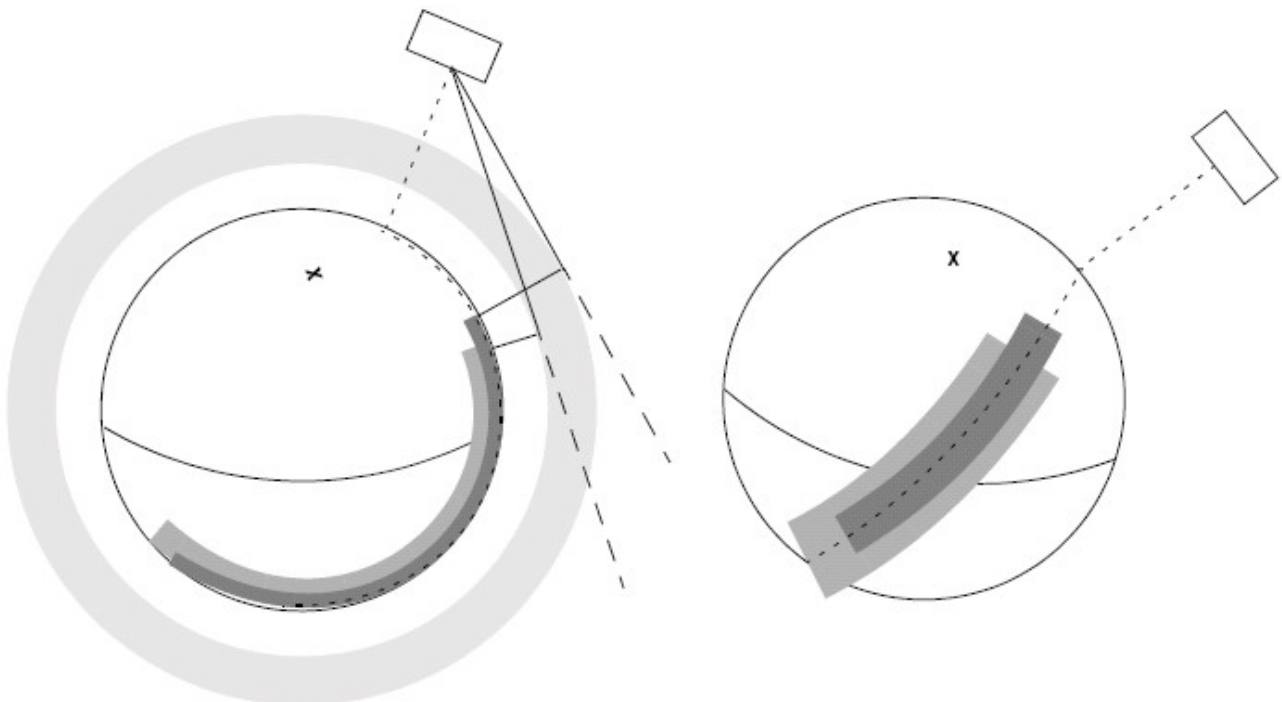

**Figure 14: Limb-sounding instrument: swath definition (2)**

### 7.3.2.3 Limb-sounding Instruments Inertial Swath Definition

This type corresponds to the observation of inertial targets (e.g. Gomos occultation mode and Mipas Line of Sight mode in Envisat). For the CFI function **xv\_star\_vis\_time** the FOV direction in inertial coordinates must be available. Therefore for these instrument modes the direction in inertial space, for a given tangent altitude, is given in the swath template file.

### 7.3.2.4 Swath Definition for Envisat

Next table lists all instrument modes and the relevance of the swaths for Envisat. It shows also:

- the prefix to be used when generating the swath template file name
- the different types of algorithms to be used by **xv\_gen\_swath** (this is transparent to the user)

**Table 12: Envisat Swaths**

| instrument | Mode                              | File Prefix<br>= swath | Swath<br>geometry<br>(Table 90) | Swath Type         | Remarks   |
|------------|-----------------------------------|------------------------|---------------------------------|--------------------|---|
| RA         |                                   | RA_2__                 | POINTING (1 point)              | Nadir point        | Modeled as sub-satellite track  |
| MERIS      | Averaging /<br>Direct & Averaging | MERIS_                 | POINTING (3 points)             | Nadir line         |   |
| ASAR       | Image Modes (IS1... IS7)          | SARxIM (x=1...7)       | ASAR                            | Nadir line         | Modeled as a continuous swath any where within the image swath  |
|            | Alt. Polarization (IS1... IS7)    |                        |                                 |                    |   |
|            | Wide Swath                        | SARWIM                 |                                 |                    |   |
|            | Global Monitoring                 |                        |                                 |                    |   |
|            | Wave (IS1... IS7)                 | SARxWV (x=1...7)       |                                 |                    |   |
| GOMOS      | Occultation                       | GOMOIL<br>GOMOIH       | INERTIAL                        | Inertial direction | IFOV much smaller than swath.<br>IFOV Very dependent on star avail ability.<br><br>2 swaths defined:<br>- 1 for high altitude (GOMOIH)<br>- 1 for low altitude (GOMOIL) |
|            | Occultation                       | GOMO_H<br>GOMO_L       | LIMB                            | Limb wide          | Same mode as above, now swath defined as Earth-fixed location.<br><br>IFOV much smaller than swath.<br>IFOV Very dependent on star avail ability.                       |

|           |                                     |  |                        |                       |  |
|-----------|-------------------------------------|--|------------------------|-----------------------|--|
|           |                                     |  |                        |                       | 2 swaths defined:<br>- 1 for high altitude (GOMO_H)<br>- 1 for low altitude (GOMO_L)   |
| SCIAMACHY | Nadir /<br>Nadir of Nadir &<br>Limb | SCIAN_                                   | POINTING (3<br>points) | Nadir line            | Continuous Nadir swath modeled   |
|           | Limb /<br>Limb of Nadir &<br>Limb   | SCIALH<br>SCIALL                         |                        | Limb wide             | 2 swaths defined:<br>- 1 for high altitude (SCIALH)<br>- 1 for low altitude (SCIALL)   |
| AATSR     |                                     | ATSR_N<br>ATSR_F                         | POINTING (3<br>points) | Nadir line            | 2 swaths defined:<br>- 1 for nadir swath<br>- 1 for forward swath  |
| MWR       |                                     | MWR__                                    | POINTING (1<br>points) | Nadir point           | Modeled as sub-satellite track   |
| MIPAS     | Nominal                             | MIPN_H<br>MIPN_L                         | LIMB                   | Limb narrow           | 2 swaths defined:<br>- 1 for high altitude (MIPN_H)<br>- 1 for low altitude (MIPN_L)   |
|           | Special Event<br>Mode<br>(across)   | MIP_X_                                   | LIMB                   | Limb narrow           | Modeled as an across track swath,<br>in the middle of the MIPAS SEM<br>acquisition scan.   |
|           | Special Event<br>Mode<br>(rearward) | MIP_RH<br>MIP_RL                         | LIMB                   | Limb wide             | IFOV much smaller than swath.<br>2 swaths defined:<br>- 1 for high altitude (MIP_RH)<br>- 1 for low altitude (MIP_RL)  |
|           | Rearward<br><br>Sideward            | MIPIRH<br>MIPIRL<br><br>MIPIXH<br>MIPIXL | INERTIAL               | Inertial<br>direction | 2 swaths defined for rearward<br>mode:<br>- 1 for high altitude (MIPIRH)<br>- 1 for low altitude (MIPIRL)<br>3 swaths defined for sideward<br>mode:<br>- 1 for high altitude (MIPIXH)<br>- 1 for back mode (MIPIXB)<br>- 1 for forward mode (MIPIXF) |

### 7.3.3 Zone Borders and Projection

When defining a polygon zone, the user is assumed to wish polygon sides as straight lines. But on the earth surface, a straight line is, at best, a confusing concept.

The only way to define unambiguously straight lines is to work in a 2-dimensional projection of the earth surface. There are many possible projections, each having advantages and drawbacks.

`xv_zonevistime_compute` can handle zone borders in 2 different projections:

- rectangular projection, using longitude and latitude as the X and Y axis; this is appropriate to express zones where (some of) the edges follow constant latitude lines, and provide a reasonable approximation for straight lines at low-medium latitudes
- azimuthal gnomonic projection, where great circles are always projected as straight lines; this is better for high latitudes, where the rectangular projection suffers from too much distortion and the singularity at the poles.

`xv_zonevistime_compute` allows the user to specify which projection he wants to work in, i.e. in which projection the polygon sides will be represented by `xv_zonevistime_compute` as straight lines. The user is assumed to be aware of how the polygon sides behave on the Earth surface.

### 7.3.4 Zone Definition

The user-defined zone can be either (see Table 13);

- a point
- a line
- a polygon
- a circle

A zone is defined by the area of the earth surface enclosed by the zone borders:

- in the case of a circular zone, the area inside the circle
- in the case of a polygonal zone, the area which is always to the right of any polygon side; if the polygon is defined as a sequence of N points, each polygon side is considered as a line from point i to point i+1; this unambiguously defines the right side of the polygon sides.

**Table 13: Zone definition (for `xd_zone_rec`)**

| Zone definition | num_points | zone_point (long, lat) | zone_diam              | Description  |
|-----------------|------------|------------------------|------------------------|--|
| Circular Zone   | 1          | [0]: centre point      | yes<br>zone_diam > 0.0 | The zone is represented as a circle, around the centre point   |
| Point Zone      | 1          | [0]: Point             | yes<br>zone_diam = 0.0 | The zone is defined by the point. Resulting segments will have a zero duration. The zone will always be completely covered by the swath. |
| Line Zone       | 2          | [0], [1]: Line         | no                     | The zone is defined by the line from point [0] to point [1].   |
| Polygon Zone    | >2         | [i]                    | no                     | The zone is defined by the area right of the line from point [i] to point [i+1].   |

For the gnomonic projection, a side of a zone is always smaller than a half great circle, because two polygon points are considered to be joined by the shortest line.

For the rectangular projection, two consecutive points of the zone are also joined by the shortest line; so the difference in longitude must be less than 180 degrees.

The polygon zone can be closed (i.e. the first and last points are the same) or not. If the zone is not closed, `xv_zonevistime_compute` closes it by joining the last point with the first one in its internal computations.

See Figure 15 for examples of zone definitions.

`xv_zonevistime_compute` will issue an error on the zone definition if the polygon has intersecting sides (“butterfly” zone).

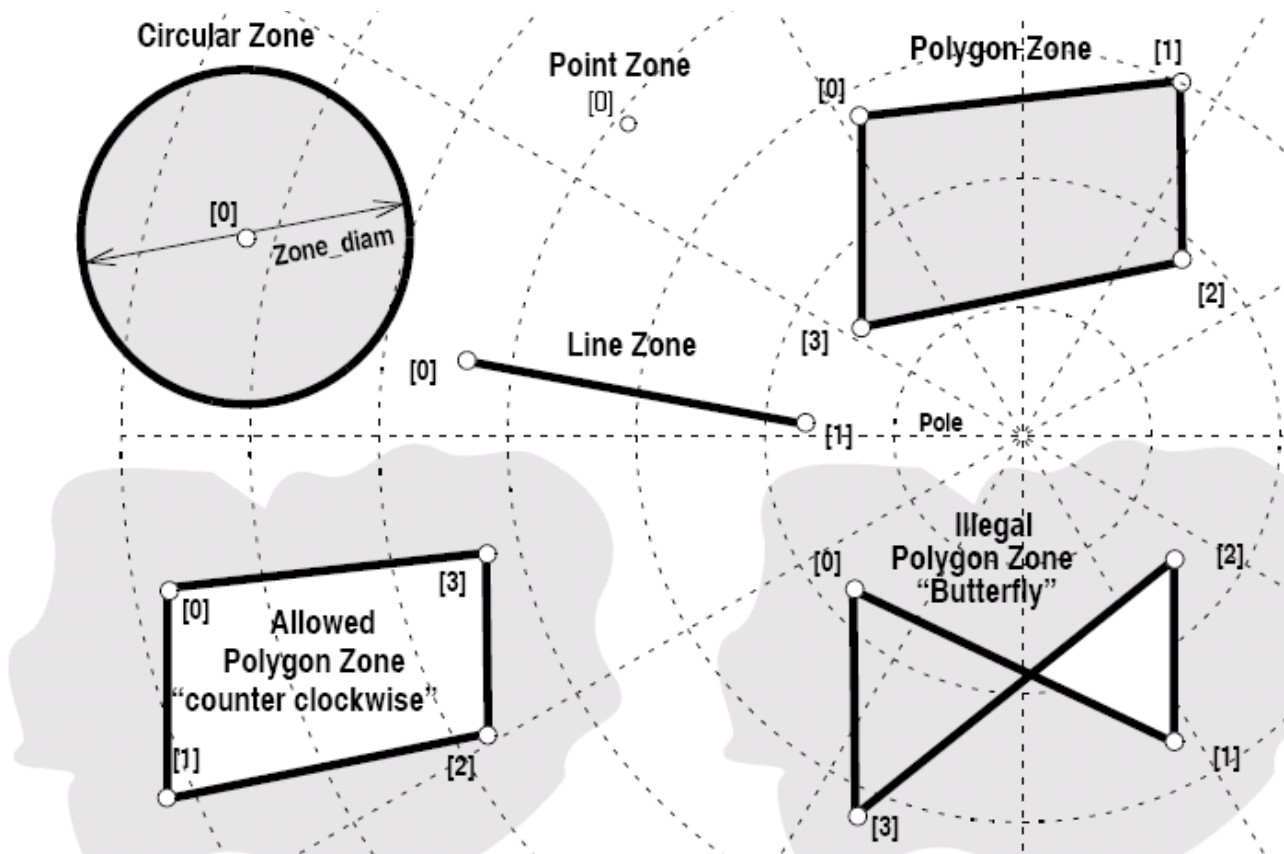

Figure 15: Zone examples

### 7.3.5 Intersection Definition

The `xv_zonevistime_compute` intersection times between the instrument swath and the user-defined zone are defined as the first and last occurrence, in chronological order with respect to the satellite direction, of the geometrical super-position of any point belonging to the instrument swath with any single point belonging to the zone (including the zone border).

The entry and exit times for each intersection are given as elapsed seconds (and microseconds) since the ascending node crossing.

Next figure shows some typical intersections.

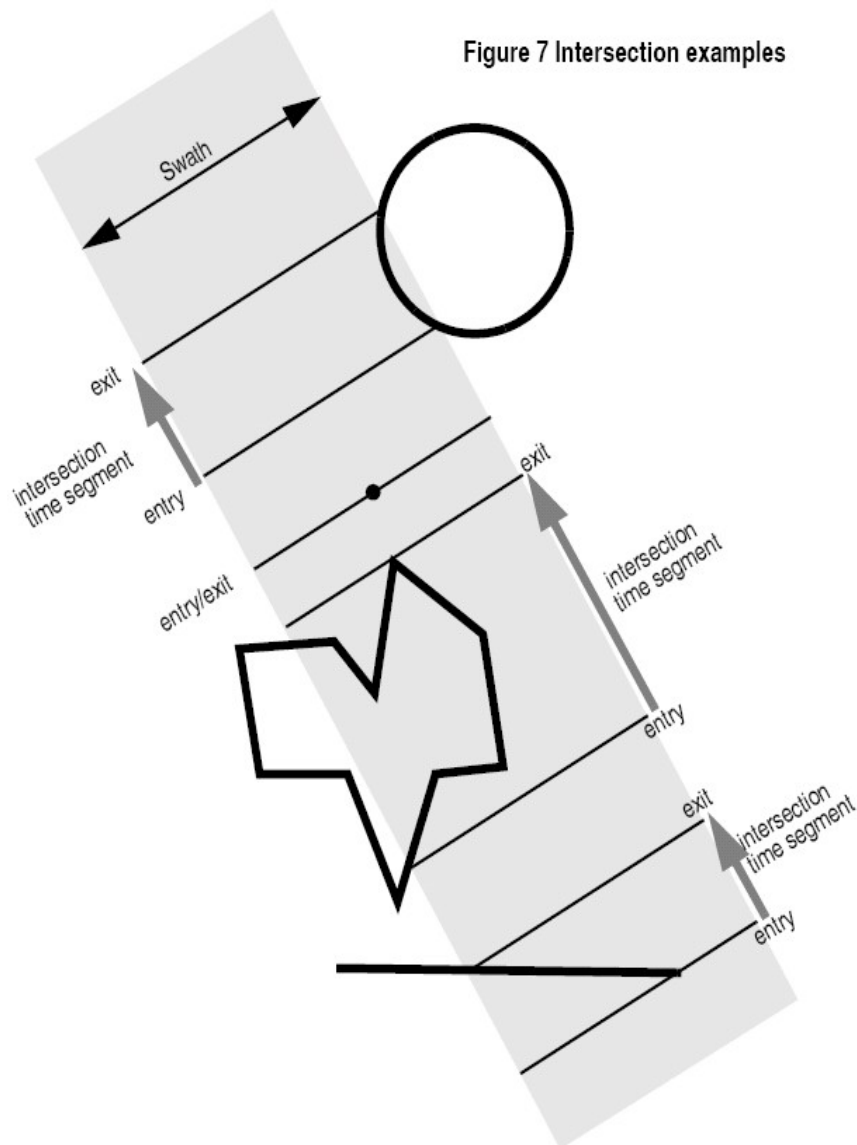

Figure 16: Intersection examples



### **7.3.6 Intersection Algorithm**

The intersection of a swath and a user-defined zone is to be performed on the Earth projected to a map plane in one of the following projections:

- Rectangular projection
- Gnomonic projection

Although the projections are quite different, the intersection rules are identical. The algorithm can however be different, in order to take advantage of a particular feature of a projection.

The purpose of the CFI function `ZONEVISTIME_COMPUTE` is to obtain quickly, accurate intersection segments with a low precision (1 second).

The algorithms assume that the polygon zones are closed and expects a wrap around between the first and the last point. Thus `ZONEVISTIME_COMPUTE` must first close the polygon if necessary.

For `ZONEVISTIME` the following swath types are defined:

- point swath: instantaneous swath is a point.
- segment swath: instantaneous swath is a segment.
- multi-segment swath: it can be open or closed.
- inertial swath: not used by `ZONEVISTIME`

The main concept in the algorithm is the transition, defined as the change in coverage of (part of) the swath and the zone (e.g. edge of the swath crosses one polygon side).

#### **7.3.6.1 Intersection with a point swath**

The vertices of the polygon defining the area are connected by straight lines in the chosen projection, along track swath points are also connected by straight lines in the same projection.

Transitions are located by linear intersection of the zone sides and the swath along track lines. A transition is only valid if the intersection occurs inside both line segments. The polygon side from  $\langle i \rangle$  to  $\langle j \rangle$  is defined in a clockwise manner inclusive point  $\langle i \rangle$  but exclusive point  $\langle j \rangle$ . The swath line from time  $\langle k \rangle$  to  $\langle l \rangle$  is defined inclusive the template point at  $\langle k \rangle$  but exclusive the template point at  $\langle l \rangle$ .

The fraction of the swath along track line determines the precise timing since time  $\langle k \rangle$  of the intersection. Also the determination if the transition is a on- or off-transition is quite trivial. First a vector is defined, perpendicular to the along track swath line, such that the vector points left. Then, the dot product of the polygon side and this vector is calculated. If the dot product is positive, the transition is on, i.e. the swath enters the zone. If the result is negative, then the swath leaves the zone. If the result equals zero then the transition can be ignored (polygon side and swath overlay, a proper transition will be found with another pair of polygon side - swath line.).

#### **7.3.6.2 Intersection with a segment swath**

The left and right side of the swath, are located using the same algorithm as for the point swath. Even left and right time segments can be made based on the left and right hand transitions.

The polygon vertices (and not the sides) are intersected with the along track moving line swath, in order to catch zones smaller than the swath, etc. Swaths for intermediate times between two consecutive times in Swath Template File are considered straight segments, joining an intermediate point of the Left swath line from time  $\langle k \rangle$  to time  $\langle l \rangle$ , with an intermediate point in Right swath line.

### 7.3.6.3 Intersection with a multi-segment swath

The algorithm used for segment swath is repeated for every segment of the swath, and the visibility segments obtained in each case are merged with the ones of the other swath segments.

For a closed swath further calculations are done: it is checked if the zone is completely inside the swath area in the interval between contiguous visibility segments, or between the beginning of the first orbit and the first visibility segment, or between the last visibility segment and the end of the last orbit computed. If it is inside, segments must be merged because the zone was visible in the interval.

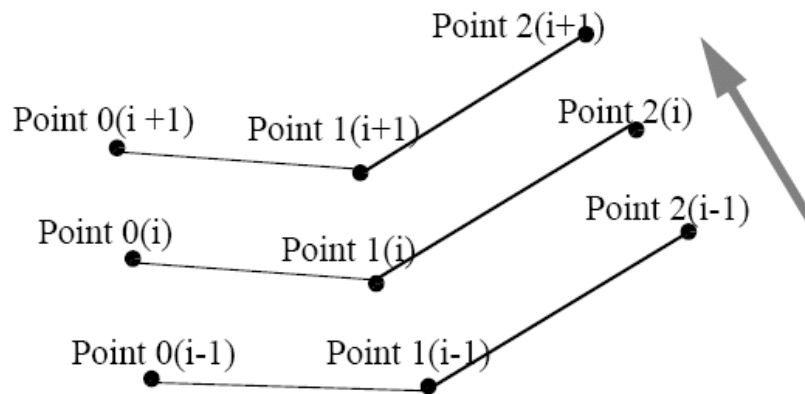

Figure 17: Swath points

## 7.3.7 Usage Hints

### 7.3.7.1 Limb-sounding Instruments Intersection

In the case of limb-sounding instrument with a potentially wide azimuth field of view, 2 swaths have to be considered (1 for minimum altitude, 1 for maximum altitude). Furthermore, these 2 swaths are offset in time (i.e. their projection on the earth intersect with a given point at different times). To cope with this, the user must do the following:

- call `xv_zonevistime_compute` twice (once for each extreme altitude swath)
- merge/filter the 2 sets of time segments, depending on what he wants to achieve

### 7.3.7.2 Zone Coverage

`xv_zonevistime_compute` computes purely geometrical intersections. The resulting zone visibility segments might need some additional filtering by the user. In particular, instrument constraints (e.g. only working outside of sun eclipse) have to be considered by the user.

Furthermore, to help users to deal with zones wider than the swath (i.e. requiring several orbits to cover the whole zone), `xv_zonevistime_compute` produces for each zone visibility segment an indication of the coverage type (see Figure 18) and the name of the zone (or a lists in case several zones are seen by that segment);

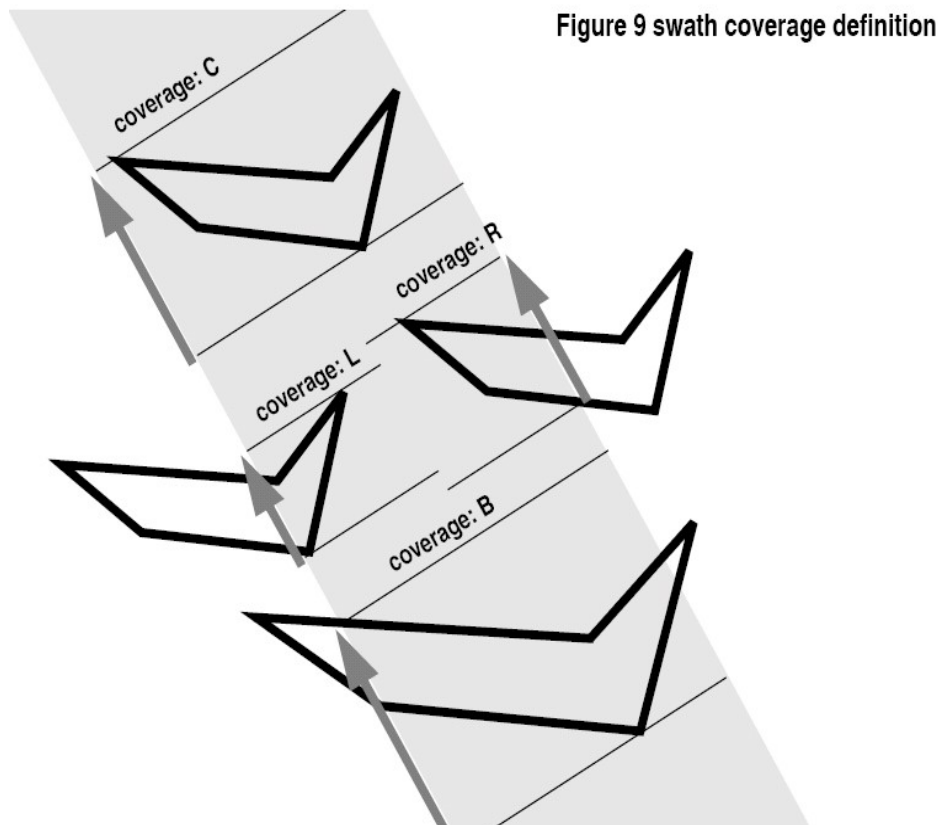

Figure 18: Swath coverage definition

- coverage = C: zone completely covered by the swath
- coverage = R: zone partially covered by the swath, extending over the right edge of the swath
- coverage = L: zone partially covered by the swath, extending over the left edge of the swath
- coverage = B: zone partially covered by the swath, extending over both edges of the swath

#### **7.3.7.3 Combined use of xv\_swathpos\_compute and the coverage flag**

The EO\_VISIBILITY function `xv_swathpos_compute` can be used to refine the work performed with `xv_zonevistime_compute`.

#### **7.3.7.4 Use of input xp\_attitude\_def\_struct**

The definition of the input structure `xp_attitude_def` can be consulted in section 6.3 of [POINT\_SUM].

The “type” field defines how this struct is used, and it can take the following values:

- `XP_NONE_ATTITUDE`: no attitude defined in struct. In this case, when the Swath Template File must be computed internally, the attitudes defined in Swath Definition File are used.
- `XP_SAT_NOMINAL_ATT`, `XP_SAT_ATT`, `XP_INSTR_ATT`: the attitudes defined in the structure are used in internal Swath Template File generation. The “type” field in this case indicates the target frame for the computation.

#### **7.3.7.5 Use of input xv\_zone\_info\_list\_struct**

The zone or zones to be used in algorithm are passed to `xv_zonevistime_compute` function with the struct `xv_zone_info_list` (see section 6.3 for description). It contains the following fields:

- `calc_flag`: it can take the enumeration values `XV_COMPUTE` or `XV_DO_NOT_COMPUTE`. This flag indicates if the extra information regarding the zones (coverage) must be computed or not.
- `num_rec`: Indicates the number of input zones where the visibility is going to be computed.
- `zone_info`: description of the zones to be computed. Every position of the array is a `xv_zone_info` struct. The value of `type` field indicates the type of zone data:
  - If `type` is equal to enum value `XV_USE_ZONE_DB_FILE`, then the zone `zone_id` is read from `zone_db_filename` zone file and `projection` projection (possible values are the following enums: `XD_READ_DB`, `XD_GNOMONIC` or `XD_RECTANGULAR`) is used.
  - If `type` is equal to enum value `XV_USE_ZONE_DATA`, then the information contained in `zone_data` field is used (see [D\_H\_SUM] for description of `xd_zone_rec`).
  - `min_duration`: indicates the minimum duration for the segments (seconds).

### 7.3.8 Calling sequence

For C programs, the call to `xv_zonevistime_compute` is (input parameters are underlined):

```
#include "explorer_visibility.h"
{
    xo_orbit_id orbit_id = {NULL};
    xp_attitude_def attitude_def;
    xv_swath_id swath_id = {NULL};
    xv_zone_info_list zone_info_list;
    xv_time_interval search_interval;
    xv_zonevisibility_interval_list visibility_interval_list;
    long ierr[XV_NUM_ERR_ZONEVISTIME_COMPUTE];

    status = xv_zonevistime_compute(&orbit_id,
                                    &attitude_def,
                                    &swath_id, &zone_info_list,
                                    &search_interval,
                                    &visibility_interval_list, ierr);

}
```

### 7.3.9 Input parameters

The `xv_zonevistime_compute` CFI function has the following input parameters:

**Table 14: Input parameters of `xv_zonevistime_compute` function**

| C name          | C type             | Array Element | Description (Reference)                                     | Unit (Format) | Allowed Range |
|-----------------|--------------------|---------------|---|---------------|---------------|
| orbit_id        | xo_orbit_id*       | -             | Structure that contains the orbit data                      | -             | -             |
| attitude_def    | xp_attitude_def*   | -             | Structure with the definition of the attitudes.             | -             | -             |
| swath_id        | xv_swath_id*       | -             | Swath id.   | -             | -             |
| zone_info_list  | xv_zone_info_list* | -             | List of zones where the visibility is going to be computed. | -             | -             |
| search_interval | xv_time_interval*  | -             | Interval where the computations are performed               | -             | -             |

### 7.3.10 Output parameters

The output parameters of the `xv_zonevistime_compute` CFI function are:

**Table 15: Output parameters of `xv_zonevistime_compute` function**

| C name  | C type  | Array Element | Description (Reference)   | Unit (Format) | Allowed Range |
|---|---|---------------|---|---------------|---------------|
| <code>xv_zonevistime_compute</code>               | long  |               | Function status flag,<br>= 0 No error<br>> 0 Warnings, results generated<br>< 0 Error, no results generated |               |               |
| <code>visibility_interval_list</code>             | <code>xv_zonevisibility_interval_list*</code> | -             | List of visibility segments and additional information  | -             | -             |
| <code>ierr[XV_NUM_ERR_ZONEVISTIME_COMPUTE]</code> | long  |               | Error status flags  |               |               |

It is also possible to use enumeration values rather than integer values for some of the output arguments, as shown in the table below:

| Input    | Description                      | Enumeration value | long |
|----------|----------------------------------|-------------------|------|
| coverage | Zone completely covered by swath | XV_COMPLETE       | 0    |
|          | Left extreme transitions found   | XV_LEFT           | 1    |
|          | Right extreme transitions found  | XV_RIGHT          | 2    |
|          | Both extreme transitions found   | XV_BOTH           | 3    |

**Memory Management:** Note that the output visibility segment list (`xv_zonevisibility_interval_list->visibility_interval`) is a pointer to the list of segments computed inside `xv_zonevistime_compute`. The memory for these dynamic array is allocated within the `xv_zonevistime_compute` function. So the user will only have to declare the variable `xv_zonevisibility_interval_list`. However, once the function has returned without error, the user will have the responsibility of freeing the memory for the pointers inside that variable and the rest of structs inside `xv_zone_coverage_info_list` struct.

### 7.3.11 Warnings and errors

Next table lists the possible error messages that can be returned by the `xv_zonevistime_compute` CFI function after translating the returned status vector into the equivalent list of error messages by calling the function of the `EO_VISIBILITY` software library `xv_get_msg`.

This table also indicates the type of message returned, i.e. either a warning (WARN) or an error (ERR), the cause of such a message and the impact on the performed calculation, mainly on the results vector.

The table is completed by the error code and value. These error codes can be obtained translating the status vector returned by the `xv_zonevistime_compute` CFI function by calling the function of the `EO_VISIBILITY` software library `xv_get_code`.

**Table 16: Error messages and codes for `xv_zonevistime_compute`**

| Error type | Error message  | Cause and impact           | Error Code   | Error No |
|------------|--|----------------------------|--|----------|
| ERR        | Input parameter \"Number of ZONE points\" is wrong.                | No computations performed. | XV_CFI_ZONEVISTIME_COMPUTE_NEGATIVE_NUM_ZONE_ERR       | 0        |
| ERR        | Input parameter \"Orbit Id\" is wrong.                             | No computations performed. | XV_CFI_ZONEVISTIME_COMPUTE_ORBIT_STATUS_ERR            | 1        |
| ERR        | Input parameter \"orbit_type\" is out of range.                    | No computations performed. | XV_CFI_ZONEVISTIME_COMPUTE_ORBIT_TYPE_ERR              | 2        |
| ERR        | Input parameter \"Minimum duration\" cannot be negative.           | No computations performed. | XV_CFI_ZONEVISTIME_COMPUTE_NEGATIVE_MIN_DURATION_ERR   | 3        |
| ERR        | Input parameter \"Projection\" out of range.                       | No computations performed. | XV_CFI_ZONEVISTIME_COMPUTE_PROJECTION_OUT_OF_RANGE_ERR | 4        |
| ERR        | Swath id not initialized   | No computations performed. | XV_CFI_ZONEVISTIME_COMPUTE_SWATH_STATUS_ERR            | 5        |
| ERR        | Swath file is not compatible with the orbit file                   | No computations performed. | XV_CFI_ZONEVISTIME_COMPUTE_WRONG_SWATH_ERR             | 6        |
| ERR        | Error reading Swath File: %s                                       | No computations performed. | XV_CFI_ZONEVISTIME_COMPUTE_READ_SWATH_FILE_ERR         | 7        |
| ERR        | Input parameter \"start_orbit\" cannot be negative.                | No computations performed. | XV_CFI_ZONEVISTIME_COMPUTE_NEGATIVE_START_ORBIT_ERR    | 8        |
| WARN       | \"start_orbit\" is before the first orbit in \"orbit_event_file\". | Computations performed.    | XV_CFI_ZONEVISTIME_COMPUTE_EARLIER_START_ORBIT_WARN    | 9        |



|      |   |                            |   |    |
|------|---|----------------------------|---|----|
| ERR  | Input parameter \"start_orbit\" cannot be greater than \"stop_orbit\".                              | No computations performed. | XV_CFI_ZONEVISTIME_C<br>OMPUTE_WRONG_ORBIT<br>_RANGE_ERR                          | 10 |
| ERR  | Error calling \"xv_orbitinfo\".   | No computations performed. | XV_CFI_ZONEVISTIME_C<br>OMPUTE_ORBITINFO_CAL<br>L_ERR                             | 11 |
| ERR  | Input parameter \"zone_id\" is an empty string.   | No computations performed. | XV_CFI_ZONEVISTIME_C<br>OMPUTE_ZONE_ID_EMPT<br>Y_ERR                              | 12 |
| ERR  | Error reading the ZONE Database file: %s  | No computations performed. | XV_CFI_ZONEVISTIME_C<br>OMPUTE_READ_ZONE_D<br>B_FILE_ERR                          | 13 |
| ERR  | Cannot (re)allocate memory for the segments.  | No computations performed. | XV_CFI_ZONEVISTIME_C<br>OMPUTE_SEGMENTS_ME<br>MORY_ERR                            | 14 |
| ERR  | Wrong input Orbit Id. Unknown orbit initialization mode   | No computations performed. | XV_CFI_ZONEVISTIME_C<br>OMPUTE_ORBIT_MODEL_<br>ERR                                | 15 |
| WARN | \"stop_orbit\" is after the last orbit in the orbit file.   | Computations performed.    | XV_CFI_ZONEVISTIME_C<br>OMPUTE_STOP_ORBIT_W<br>ARN                                | 16 |
| ERR  | Error calling \"orbit info\"  | No computations performed. | XV_CFI_ZONEVISTIME_C<br>OMPUTE_ORBIT_INFO_ER<br>R                                 | 17 |
| ERR  | Error cloning zone  | No computations performed. | XV_CFI_ZONEVISTIME_C<br>OMPUTE_CLONE_ZONE_<br>ERR                                 | 18 |
| ERR  | Input orbit interval is completely outside STF validity interval                                    | No computations performed. | XV_CFI_ZONEVISTIME_C<br>OMPUTE_ORBIT_INTERVA<br>L_STF_ERR                         | 19 |
| WARN | Input orbit interval is partially outside STF validity interval                                     | Computations performed.    | XV_CFI_ZONEVISTIME_C<br>OMPUTE_ORBIT_INTERVA<br>L_STF_WARN                        | 20 |
| WARN | Input OSF has non-trivial MLST non linear terms but STF was generated without them                  | Computations performed.    | XV_CFI_ZONEVISTIME_C<br>OMPUTE_OSF_NON_LIN_<br>STF_OLD_WARN                       | 21 |
| WARN | Swath flag larger than MLST linear approximation validity. MLST linear approximation validity used. | Computations performed.    | XV_CFI_ZONEVISTIME_C<br>OMPUTE_SWATH_FLAG_L<br>ARGER_THAN_LIN_APPR<br>OX_VAL_WARN | 22 |
| ERR  | Geostationary satellite not allowed for this function.  | No computations performed. | XV_CFI_ZONEVISTIME_C<br>OMPUTE_GEO_SAT_ERR  | 23 |
| ERR  | Error computing overlap for multizones  | No computations performed. | XV_CFI_ZONEVISTIME_C<br>OMPUTE_OVERLAP_ERR  | 24 |

|      |  |                            |  |    |
|------|--|----------------------------|--|----|
| ERR  | Error computing zonevistime loop   | No computations performed. | XV_CFI_ZONEVISTIME_COMPUTE_ZONEVISTIME_LOOP_ERR        | 25 |
| ERR  | Two ZONE segments intersect.   | No computations performed. | XV_CFI_ZONEVISTIME_COMPUTE_TWO_SEGMENT_S_INTERSECT_ERR | 26 |
| WARN | There is at least one orbital change within the requested orbit range.   | Computations performed.    | XV_CFI_ZONEVISTIME_COMPUTE_ORBITAL_CHANGE_WARN         | 27 |
| ERR  | "cycle_length" read from the input "Swath Template File" is not equal to that of any orbits within the orbit range | No computations performed. | XV_CFI_ZONEVISTIME_COMPUTE_INCONSISTENT_SWATH_ERR      | 28 |
| ERR  | Input time type is not correct   | No computations performed. | XV_CFI_ZONEVISTIME_COMPUTE_TIME_TYPE_ERR               | 32 |
| ERR  | Error checking output segments   | No computations performed. | XV_CFI_ZONEVISTIME_COMPUTE_CHECK_SEGMENTS_ERR          | 33 |
| ERR  | Error transforming time to orbit   | No computations performed. | XV_CFI_ZONEVISTIME_COMPUTE_TIME_TO_ORBIT_ERR           | 34 |
| ERR  | Error computing UTC time   | No computations performed. | XV_CFI_ZONEVISTIME_COMPUTE_GET_UTC_TIME_ERR            | 35 |
| ERR  | Input file is not a swath file   | No computations performed. | XV_CFI_ZONEVISTIME_COMPUTE_DETECT_SWATH_TYPE_ERR       | 36 |
| WARN | Visibility computations with precise propagator can be very slow   | Computation performed      | XV_CFI_ZONEVISTIME_COMPUTE_PRECISE_PROPAG_WARN         | 37 |

## 7.4 xv\_station\_vis\_time

### 7.4.1 Overview

**Note:** this function is deprecated. Use `xv_stationvistime_compute` instead.

The `xv_station_vis_time` function computes ground station visibility segments, the orbital segments for which the satellite is visible from a ground station located at the surface of the Earth.

An orbital segment is a time interval along the orbit, defined by start and stop times expressed as seconds elapsed since the ascending node crossing.

In addition, `xv_station_vis_time` calculates for every visibility segment the time of zero-doppler (i.e. the time at which the range-rate to the station is zero).

`xv_station_vis_time` requires access to several data structures and files to produce its results:

- the `orbit_id` (`xo_orbit_id`) providing the orbital data. The `orbit_id` can be initialized with the following data and files, also for precise propagation if applicable (see [ORBIT\_SUM]):
  - data for an orbital change
  - Orbit scenario files
  - Predicted orbit files
  - Orbit Event Files (**Note: Orbit Event File is deprecated, only supported for CRYOSAT mission**).
  - Restituted orbit files
  - DORIS Preliminary orbit files
  - DORIS Navigator files
  - TLE files

Note: if the orbit is initialized for precise propagation, the execution of the visibility function can be very slow. As alternative, a POF can be generated with the precise propagator (function `xo_gen_pof`) for the range of orbits the user usually needs, and use this generated file to initialize the orbit id. The execution time performance will be much better for the visibility function and it will not have a big impact on the precision of the calculations.

- the Instrument Swath File, describing the area seen by the relevant instrument all along the current orbit. The Swath data can be provided by:
  - A swath template file produced off-line by the EO\_VISIBILITY library (`xv_gen_swath` function).
  - A swath definition file, describing the swath geometry. In this case the `xv_station_vis_time` generates the swath points for a number of orbits given by the user.
- The Station Database File, describing the location and the physical mask of each ground station, and the mask parameters for a list of spacecrafts from each station (considered only when mask 'from file' option is selected).

The time intervals used by `xv_station_vis_time` are expressed in absolute or relative orbit numbers. This is valid for both:

- input parameter “Orbit Range”: first and last orbit to be considered. In case of using relative orbits, the corresponding cycle number should be used, otherwise, this the cycle number will be a dummy parameter.

- output parameter “Station Visibility Segments”: time segments with time expressed as {absolute orbit number (or relative orbit and cycle number), number of seconds since ANX, number of microseconds}

The orbit representation (absolute or relative) for the output segments will be the same as in the input orbits. Moreover, the segments will be ordered chronologically.

Users who need to use processing times must make use of the conversion routines provided in EO\_ORBIT (**xo\_time\_to\_orbit** and **xo\_orbit\_to\_time** functions).

**NOTE:** If **xv\_station\_vis\_time** is used with a range of orbits that includes an orbital change (e.g. change in the repeat cycle or cycle length), the behaviour depends on the swath file introduced as input:

•If a **swath template file** is used, **xv\_station\_vis\_time** automatically will ignore the orbits that do not correspond with the template file (i.e. no visibility segments will be generated for those orbits), since swath template file is generated from a reference orbit with a particular geometry, so it is not valid for a different geometry.

•If a **swath definition file** is introduced, **xv\_station\_vis\_time** will perform the computations across orbital changes, and will return the visibility segments corresponding to the whole orbital range. Internally, swath template files valid for every orbital change are generated to perform the calculations.

**NOTE 2:**If a swath template file with the variable header tags *Start\_VValidity\_Range* and *Stop\_VValidity\_Range* is used as input, only the segments belonging to that orbit range will be returned.

**NOTE 3:** If a swath definition file is introduced, it can be also introduced every how many orbits the swath template file must be recomputed (**swath\_flag** parameter, see section 111). If the **orbit\_id** has been initialized with an OSF file with MLST non linear terms and the parameter **swath\_flag** is greater than the linear approximation validity, the recomputation of swath template file will be done every linear approximation validity orbits.

## 7.4.2 Calling interface

For C programs, the call to `xv_station_vis_time` is (input parameters are underlined):

```
#include "explorer_visibility.h"
{
    xo_orbit_id orbit_id = {NULL};
    long    swath_flag, orbit_type,
           start_orbit, start_cycle,
           stop_orbit, stop_cycle,
           mask, number_segments,
           *bgn_orbit, *bgn_second,
           *bgn_microsec, *bgn_cycle,
           *end_orbit, *end_second,
           *end_microsec, *end_cycle,
           *zdop_orbit, *zdop_second,
           *zdop_microsec, *zdop_cycle,
           ierr[XV_NUM_ERR_STATION_VIS_TIME],
           status;
    double  aos_elevation, los_elevation, min_duration;
    char    *swath_file;
    char    *sta_id, *sta_db_file;

    status = xv_station_vis_time(
        &orbit_id, &orbit_type,
        &start_orbit, &start_cycle,
        &stop_orbit, &stop_cycle,
        &swath_flag, &swath_file, sta_id, sta_db_file,
        &mask, &aos_elevation, &los_elevation,
        &min_duration,
        &number_segments,
        &bgn_orbit, &bgn_second,
        &bgn_microsec, &bgn_cycle,
        &end_orbit, &end_second,
        &end_microsec, &end_cycle,
        &zdop_orbit, &zdop_second,
        &zdop_microsec, &zdop_cycle,
        ierr);
}
```

```
/* Or, using the run_id */
long run_id;

status = xv_station_vis_time_run(
    &run_id, &orbit_type,
    &start_orbit, &start_cycle,
    &stop_orbit, &stop_cycle,
    &swath_flag, &swath_file, sta_id, sta_db_file,
    &mask, &aos_elevation, &los_elevation,
    &min_duration,
    &number_segments,
    &bgn_orbit, &bgn_second,
    &bgn_microsec, &bgn_cycle,
    &end_orbit, &end_second,
    &end_microsec, &end_cycle,
    &zdop_orbit, &zdop_second,
    &zdop_microsec, &zdop_cycle,
    ierr);
}
```

### 7.4.3 Input parameters

Table 17: Input parameters of xv\_station\_vis\_time

| C name      | C type       | Array Element | Description (Reference)  | Unit (Format)                     | Allowed Range   |
|-------------|--------------|---------------|--|-----------------------------------|---|
| orbit_id    | xo_orbit_id* | -             | Structure that contains the orbit data   | -                                 | -   |
| orbit_type  | long         | -             | Define the type of orbit representation, i.e. absolute or relative orbits in the input/output parameters   | -                                 | Complete  |
| start_orbit | long         | -             | First orbit, segment filter.<br>Segments will be filtered as from the beginning of first orbit (within orbit range from orbit_scenario_file)<br>First Orbit in the orbit_scenario_file will be used when: <ul style="list-style-type: none"> <li>Absolute orbit is set to zero.</li> <li>Relative orbit and cycle number set to zero.</li> </ul>   | absolute or relative orbit number | = 0<br>or:<br><ul style="list-style-type: none"> <li>absolute orbits <math>\geq</math>start_osf</li> <li>relative orbits <math>\leq</math>repeat cyc</li> </ul>   |
| start_cycle | long         | -             | Cycle number corresponding to the start_orbit. Dummy when using relative orbits  | cycle number                      | = 0 or $\geq$ first cycle in osf  |
| stop_orbit  | long         | -             | Last orbit, segment filter.<br>When: <ul style="list-style-type: none"> <li>stop_orbit = 0 (for orbit_type = XV_ORBIT_ABS)</li> <li>stop_orbit = 0 and stop_cycle = 0 (for orbit_type = XV_ORBIT_REL)</li> </ul> the stop_orbit will be set to the minimum value between: <ul style="list-style-type: none"> <li>the last orbit within the orbital change of the start_orbit.</li> <li>start_orbit+cycle_length-1 (i.e. the input orbit range will be a complete cycle)</li> </ul> If it is not initialized with orbital changes, stop orbit will be set to the last orbit in orbit_id initialization. | absolute or relative orbit number | = 0<br>or:<br><ul style="list-style-type: none"> <li>absolute orbits <math>\geq</math>start_osf</li> <li>relative orbits <math>\leq</math>repeat cycle</li> </ul> |
| stop_cycle  | long         | -             | Cycle number corresponding to the stop_orbit. Dummy when using relative orbits   | cycle number                      | = 0 or $\geq$ first cycle in osf  |

|                 |        |   |  |     |                                 |
|-----------------|--------|---|--|-----|---------------------------------|
| swath_flag      | long*  | - | Define the use of the swath file:<br><ul style="list-style-type: none"> <li>• 0 = (XV_STF) if the swath file is a swath template file.</li> <li>• &gt; 0 if the swath files is a swath definition file. In this case the swath points are generated for every "swath_flag" orbits</li> </ul> | -   | XV_STF = 0<br>XV_SDF = 1<br>> 0 |
| swath_file      | char * | - | File name of the swath-file for the appropriate instrument mode  |     |                                 |
| sta_id          | char*  |   | identification name of the station   |     |                                 |
| station_db_file | char * |   | File name of the station database file<br>This file is read each time the function is called   |     |                                 |
| mask            | long   |   | mask used to define visibility<br>= XV_COMBINE combine AOS/LOS elevations and physical mask (nominal mode)<br>= XV_AOS_LOS consider only AOS/LOS elevations<br>= XV_PHYSICAL consider only physical mask<br>= XV_FROM_FILE consider mask given in the Station Database File                  |     | all                             |
| aos_elevation   | double |   | Minimum elevation to consider at AOS (i.e. before considering start of visibility).<br>Not used if mask=XV_FROM_FILE   | deg | ≥ 0.0                           |
| los_elevation   | double |   | Maximum elevation to consider at LOS (i.e. before considering end of visibility).<br>Not used if mask=XV_FROM_FILE   | deg | ≥ 0.0<br>aos_elevation          |
| min_duration    | double |   | Minimum duration for segments.<br>Only segments with a duration longer than min_duration will be given on output.  | s   | ≥ 0.0                           |

It is also possible to use enumeration values rather than integer values for some of the input arguments, as shown in the table below:

| Input | Description                       | Enumeration value | long |
|-------|-----------------------------------|-------------------|------|
| mask  | Combine AOS/LOS and physical mask | XV_COMBINE        | 0    |



---

|  |                        |              |   |
|--|------------------------|--------------|---|
|  | Use only AOS/LOS       | XV_AOS_LOS   | 1 |
|  | Use only physical mask | XV_PHYSICAL  | 2 |
|  | Use mask from file     | XV_FROM_FILE | 3 |

## 7.4.4 Output parameters

Table 18: Output parameters of `xv_station_vis_time` function

| C name                           | C type | Array Element | Description   | Unit (Format) | Allowed Range                          |
|----------------------------------|--------|---------------|---|---------------|--|
| <code>xv_station_vis_time</code> | long   |               | Function status flag,<br>= 0 No error<br>> 0 Warnings, results generated<br>< 0 Error, no results generated   |               |  |
| <code>number_segments</code>     | long   |               | Number of visibility segments returned to the user  |               | $\geq 0$                               |
| <code>bgn_orbit</code>           | long*  | all           | Orbit number,<br>begin of visibility segment <i>i</i><br><code>bgn_orbit[i-1]</code> ,<br><i>i</i> = 1, <code>number_segments</code>                  |               | > 0                                    |
| <code>bgn_second</code>          | long*  | all           | Seconds since ascending node,<br>begin of visibility segment <i>i</i><br><code>bgn_second[i-1]</code> ,<br><i>i</i> = 1, <code>number_segments</code> | s             | $\geq 0$<br>< orbital period           |
| <code>bgn_microsec</code>        | long*  | all           | Micro seconds within second<br>begin of visibility segment <i>i</i><br><code>bgn_microsec[i-1]</code> ,<br><i>i</i> = 1, <code>number_segments</code> | $\mu$ s       | $\geq 0$<br>$\leq 999999$              |
| <code>bgn_cycle</code>           | long*  | all           | Cycle number,<br>begin of visibility segment <i>i</i><br><code>bgn_cycle[i-1]</code> ,<br><i>i</i> = 1, <code>number_segments</code>                  |               | > 0<br>NULL when using absolute orbits |
| <code>end_orbit</code>           | long*  | all           | Orbit number,<br>end of visibility segment <i>i</i><br><code>end_orbit[i-1]</code> ,<br><i>i</i> = 1, <code>number_segments</code>                    |               | > 0                                    |
| <code>end_second</code>          | long*  | all           | Seconds since ascending node,<br>end of visibility segment <i>i</i><br><code>end_second[i-1]</code> ,<br><i>i</i> = 1, <code>number_segments</code>   | s             | $\geq 0$<br>< orbital period           |
| <code>end_microsec</code>        | long*  | all           | Micro seconds within second   | $\mu$ s       | $\geq 0$                               |

|                                   |       |     |  |    |   |
|-----------------------------------|-------|-----|--|----|---|
|                                   |       |     | end of visibility segment i<br>end_microsec[i-1],<br>i = 1, number_segments  |    | ≤ 999999                                  |
| end_cycle                         | long* | all | Cycle number,<br>end of visibility segment i<br>end_cycle[i-1],<br>i = 1, number_segments  |    | >0<br><br>NULL when using absolute orbits |
| zdop_orbit                        | long* | all | Orbit number,<br>time of zero doppler (-1 if no zero doppler within corresponding visibility segment)<br>zdop_orbit[i-1],<br>i = 1, number_segments                  |    | > 0                                       |
| zdop_second                       | long* | all | Seconds since ascending node,<br>time of zero doppler (-1 if no zero doppler within corresponding visibility segment)<br>zdop_second[i-1],<br>i = 1, number_segments | s  | >= 0<br><br>< orbital period              |
| zdop_microsec                     | long* | all | Micro seconds within second<br>time of zero doppler (-1 if no zero doppler within corresponding visibility segment)<br>zdop_microsec[i-1],<br>i = 1, number_segments | μs | 0 =<<br><br>=< 999999                     |
| zdop_cycle                        | long* | all | Cycle number,<br>time of zero doppler (-1 if no zero doppler within corresponding visibility segment)<br>zdop_second[i-1],<br>i = 1, number_segments                 |    | >0<br><br>NULL when using absolute orbits |
| ierr[XV_NUM_ERR_STATION_VIS_TIME] | long  |     | Error status flags   |    |   |

**Memory Management:** Note that the output visibility segments arrays are pointers to integers instead of static arrays. The memory for these dynamic arrays is allocated within the **xv\_station\_vis\_time** function. So the user will only have to declare those pointers but not to allocate memory for them. However, once the function has returned without error, the user will have the responsibility of freeing the memory for those pointers once they are not used.

### 7.4.5 Warnings and errors

Next table lists the possible error messages that can be returned by the `xv_station_vis_time` CFI function after translating the returned status vector into the equivalent list of error messages by calling the function of the `EO_VISIBILITY` software library `xv_get_msg`.

This table also indicates the type of message returned, i.e. either a warning (WARN) or an error (ERR), the cause of such a message and the impact on the performed calculation, mainly on the results vector.

The table is completed by the error code and value. These error codes can be obtained translating the status vector returned by the `xv_station_vis_time` CFI function by calling the function of the `EO_VISIBILITY` software library `xv_get_code`.

**Table 19: Error messages and codes for `xv_station_vis_time`**

| Error type | Error message  | Cause and impact          | Error Code                                   | Error No |
|------------|--|---------------------------|--|----------|
| ERR        | Error in input parameter Orbit Id.                               | Computation not performed | XV_CFI_STATION_VIS_TIME_ORBIT_STATUS_ERR     | 0        |
| ERR        | Error in input parameter to stavistime.                          | Computation not performed | XV_CFI_STATION_VIS_TIME_INPUTS_CHECK_ERR     | 1        |
| ERR        | Input parameter "orbit_type" is out of range.                    | Computation not performed | XV_CFI_STATION_VIS_TIME_ORBIT_TYPE_ERR       | 2        |
| ERR        | Wrong input Orbit Id. Unknown orbit initialization mode          | Computation not performed | XV_CFI_STATION_VIS_TIME_ORBIT_MODEL_ERR      | 3        |
| ERR        | Error transforming start orbit from relative to absolute orbits. | Computation not performed | XV_CFI_STATION_VIS_TIME_REL_TO_ABS_START_ERR | 4        |
| ERR        | Error transforming stop orbit from relative to absolute orbits   | Computation not performed | XV_CFI_STATION_VIS_TIME_REL_TO_ABS_STOP_ERR  | 5        |
| ERR        | Error reading the Orbit scenario file.                           | Computation not performed | XV_CFI_STATION_VIS_TIME_OSF_READ_ERR         | 6        |
| ERR        | Error reading the swath template file.                           | Computation not performed | XV_CFI_STATION_VIS_TIME_SWATH_FLAG_ERR       | 7        |
| ERR        | Error reading the swath template file.                           | Computation not performed | XV_CFI_STATION_VIS_TIME_SWATH_READ_ERR       | 8        |
| ERR        | Error wrong swath type selected.                                 | Computation not performed | XV_CFI_STATION_VIS_TIME_SWATH_TYPE_ERR       | 9        |

|       |   |   |  |    |
|-------|---|---|--|----|
| ERR   | Swath file is not compatible with the orbit file  | Computation not performed                             | XV_CFI_STATION_VI<br>S_TIME_WRONG_SWATH_ERR        | 10 |
| WAR N | Warning, start orbit is outside range of OSF.   | Computation performed.<br>Message to inform the user. | XV_CFI_STATION_VI<br>S_TIME_FIRST_ORBIT_WARN       | 11 |
| WAR N | Warning, stop orbit is outside range of OSF.  | Computation performed.<br>Message to inform the user. | XV_CFI_STATION_VI<br>S_TIME_LAST_ORBIT_WARN        | 12 |
| ERR   | Actual stop orbit is earlier than actual start orbit.   | Computation not performed                             | XV_CFI_STATION_VI<br>S_TIME_WRONG_INTERVAL_ERR     | 13 |
| ERR   | Error obtaining orbital information in orbit info.  | Computation not performed                             | XV_CFI_STATION_VI<br>S_TIME_ORBIT_INFO_ERR         | 14 |
| WAR N | Warning, there is an orbital change within the requested orbits.                                | Computation performed.<br>Message to inform the user. | XV_CFI_STATION_VI<br>S_TIME_ORBIT_CHANGE_WARN      | 15 |
| ERR   | Error allocating internal memory.   | Computation not performed                             | XV_CFI_STATION_VI<br>S_TIME_INTERNAL_MEMORY_ERR    | 16 |
| ERR   | There is a potential memory overload, try with a smaller orbital interval.                      | Computation not performed                             | XV_CFI_STATION_VI<br>S_TIME_POTENTIAL_MEMORY_ERR   | 17 |
| ERR   | Orbital information does not coincide with reference swath.                                     | Computation not performed                             | XV_CFI_STATION_VI<br>S_TIME_INCONSISTENT_SWATH_ERR | 18 |
| ERR   | Error read info the ground station's mask data file.  | Computation not performed                             | XV_CFI_STATION_VI<br>S_TIME_READ_STATION_MASK_ERR  | 19 |
| ERR   | Error transforming the station's mask into an equivalent zone.                                  | Computation not performed                             | XV_CFI_STATION_VI<br>S_TIME_AZEL2LONLAT_ERR        | 20 |
| ERR   | Error calling ZONEVISTIME to calculate transitions.   | Computation not performed                             | XV_CFI_STATION_VI<br>S_TIME_ZONE_VISTIME_CALL_ERR  | 21 |
| ERR   | Error refining intersection time.   | Computation not performed                             | XV_CFI_STATION_VI<br>S_TIME_CALL_STAVISS_ERR       | 22 |
| WAR N | Accuracy of 0.001 deg in elevation not reached in orbit %li. Orbit too close to the mask limit. | Computation performed.<br>Message to inform the user. | XV_CFI_STATION_VI<br>S_TIME_CALL_STAVISS_WARN      | 23 |
| ERR   | Error allocating memory for the time segments.  | Computation not performed.                            | XV_CFI_STATION_VI<br>S_TIME_SEGMENTS_MEMORY_ERR    | 24 |
| ERR   | Error calculating zero  | Computation not performed                             | XV_CFI_STATION_VI                                  | 25 |

|      |   |   |   |    |
|------|---|---|---|----|
|      | doppler interval.   |   | S_TIME_ZERO_DOPPLER_ERR   |    |
| WARN | Segment longer than half nodal period deleted.  | Computation performed.<br>Message to inform the user. | XV_CFI_STATION_VIS_TIME_LONG_SEGMENT_SKIPPED_WARN                       | 26 |
| ERR  | Error transforming from absolute to relative.   | Computation not performed                             | XV_CFI_STATION_VIS_TIME_ABS_TO_REL_ERR                                  | 27 |
| ERR  | Error in the mask type read from the mask data given in the file                                    | Computation not performed                             | XV_CFI_STATION_VIS_TIME_MASK_FROM_FILE_MASK_TYPE_ERR                    | 32 |
| ERR  | Error finding the spacecraft for the station when mask data given from file                         | Computation not performed                             | XV_CFI_STATION_VIS_TIME_MASK_FROM_FILE_NO_SC_ERR                        | 33 |
| ERR  | Error converting zone point array to zone record  | Computation not performed                             | XV_CFI_STATION_VIS_TIME_CONVERT_ZONE_ERR                                | 34 |
| ERR  | Input orbit interval is completely outside STF validity interval                                    | Computation not performed                             | XV_CFI_STATION_VIS_TIME_ORBIT_INTERVAL_STF_ERR                          | 35 |
| WARN | Input orbit interval is partially outside STF validity interval                                     | Computation performed                                 | XV_CFI_STATION_VIS_TIME_ORBIT_INTERVAL_STF_WARN                         | 36 |
| ERR  | Input OSF has non-trivial MLST non linear terms but STF was generated without them                  | Computation not performed                             | XV_CFI_STATION_VIS_TIME_OSF_NON_LIN_STF_OLD_WARN                        | 37 |
| WARN | Swath flag larger than MLST linear approximation validity. MLST linear approximation validity used. | Computation performed                                 | XV_CFI_STATION_VIS_TIME_SWATH_FLAG_LARGER_THAN_LIN_APPROX_VALIDITY_WARN | 38 |
| ERR  | Geostationary satellite not allowed for this function.  | Computation not performed                             | XV_CFI_STATION_VIS_TIME_GEO_SAT_ERR                                     | 39 |
| WARN | Deprecated function. Use xv_stationvistime_compute instead  | Computation performed                                 | XV_CFI_STATION_VIS_TIME_DEPRECATED_WARN                                 | 40 |
| WARN | Visibility computations with precise propagator can be very slow                                    | Computation performed                                 | XV_CFI_STATION_VIS_TIME_PRECISE_PROPAGATOR_WARN                         | 41 |

## 7.5 xv\_station\_vis\_time\_no\_file

### 7.5.1 Overview

**Note:** this function is deprecated. Use `xv_stationvistime_compute` instead.

The `xv_station_vis_time_no_file` function computes ground station visibility segments, the orbital segments for which the satellite is visible from a ground station located at the surface of the Earth.

The aim of this function is to provide another interface for the function `xv_station_vis_time` in which the station and the swath are not provided with files but with data structures (see section 7.2.2).

### 7.5.2 Calling interface

For C programs, the call to `xv_station_vis_time_no_file` is (input parameters are underlined):

```
#include"explorer_visibility.h"
{
    xo_orbit_id orbit_id = {NULL};
    long        swath_flag, orbit_type,
               start_orbit, start_cycle,
               stop_orbit, stop_cycle,
               mask, number_segments,
               *bgn_orbit, *bgn_second,
               *bgn_microsec, *bgn_cycle,
               *end_orbit, *end_second,
               *end_microsec, *end_cycle,
               *zdop_orbit, *zdop_second,
               *zdop_microsec, *zdop_cycle,
               ierr[XV_NUM_ERR_STATION_VIS_TIME],
               status;
    double  aos_elevation, los_elevation, min_duration;
    xd_stf_file  stf_data;
    xd_station_rec station_data;

    status = xv_station_vis_time_no_file(
        &orbit_id, &orbit_type,
        &start_orbit, &start_cycle,
        &stop_orbit, &stop_cycle,
        &stf_data, &station_data,
        &mask, &aos_elevation, &los_elevation,
        &min_duration,
        &number_segments,
        &bgn_orbit, &bgn_second,
```

```
        &bgn_microsec, &bgn_cycle,  
        &end_orbit, &end_second,  
        &end_microsec, &end_cycle,  
        &zdop_orbit, &zdop_second,  
        &zdop_microsec, &zdop_cycle,  
        ierr);  
  
/* Or, using the run_id */  
long run_id;  
  
status = xv_station_vis_time_no_file_run(  
        &run_id, &orbit_type,  
        &start_orbit, &start_cycle,  
        &stop_orbit, &stop_cycle,  
        &stf_data, &station_data,  
        &mask, &aos_elevation, &los_elevation,  
        &min_duration,  
        &number_segments,  
        &bgn_orbit, &bgn_second,  
        &bgn_microsec, &bgn_cycle,  
        &end_orbit, &end_second,  
        &end_microsec, &end_cycle,  
        &zdop_orbit, &zdop_second,  
        &zdop_microsec, &zdop_cycle,  
        ierr);  
}
```



### 7.5.3 Input parameters

Table 20: Input parameters of *xv\_station\_vis\_time\_no\_file*

| C name      | C type       | Array Element | Description  | Unit (Format)                     | Allowed Range   |
|-------------|--------------|---------------|--|-----------------------------------|---|
| orbit_id    | xo_orbit_id* | -             | Structure that contains the orbit data   | -                                 | -   |
| orbit_type  | long         | -             | Define the type of orbit representation, i.e. absolute or relative orbits in the input/output parameters   | -                                 | Complete  |
| start_orbit | long         | -             | First orbit, segment filter.<br>Segments will be filtered as from the beginning of first orbit (within orbit range from orbit_scenario_file)<br>First Orbit in the orbit_scenario_file will be used when: <ul style="list-style-type: none"> <li>Absolute orbit is set to zero.</li> <li>Relative orbit and cycle number set to zero.</li> </ul>   | absolute or relative orbit number | = 0<br>or:<br><ul style="list-style-type: none"> <li>absolute orbits <math>\geq</math> start_osf</li> <li>relative orbits <math>\leq</math> repeat cycle</li> </ul> |
| start_cycle | long         | -             | Cycle number corresponding to the start_orbit. Dummy when using relative orbits  | cycle number                      | = 0 or<br>$\geq$ first cycle in osf   |
| stop_orbit  | long         | -             | Last orbit, segment filter.<br>When: <ul style="list-style-type: none"> <li>stop_orbit = 0 (for orbit_type = XV_ORBIT_ABS)</li> <li>stop_orbit = 0 and stop_cycle = 0 (for orbit_type = XV_ORBIT_REL)</li> </ul> the stop_orbit will be set to the minimum value between: <ul style="list-style-type: none"> <li>the last orbit within the orbital change of the start_orbit.</li> <li>start_orbit+cycle_length-1 (i.e. the input orbit range will be a complete cycle)</li> </ul> If it is not initialized with orbital changes, stop orbit will be set to the last orbit in orbit_id initialization. | absolute or relative orbit number | = 0<br>or:<br><ul style="list-style-type: none"> <li>absolute orbits <math>\geq</math> start_osf</li> <li>relative orbits <math>\leq</math> repeat cycle</li> </ul> |
| stop_cycle  | long         | -             | Cycle number corresponding to the stop_orbit. Dummy when using relative orbits   | cycle number                      | = 0 or<br>$\geq$ first cycle in osf   |
| stf_data    | xd_stf       | -             | Swath template data (structure   | -                                 | -   |

|               |                |   |   |     |                          |
|---------------|----------------|---|---|-----|--------------------------|
|               | _file          |   | described in [D_H_SUM]).<br>The swath structure can be got by: <ul style="list-style-type: none"> <li>• Reading a swath template file with the CFI function <b>xd_read_stf</b>.</li> <li>• Generating the swath data with the CFI function <b>xv_gen_swath_no_file</b></li> </ul> |     |                          |
| station_data  | xd_station_rec | - | Station data (structure described in [D_H_SUM]) that can be got by reading a station from a station database file with the CFI function <b>xd_read_station</b> .  | -   | -                        |
| mask          | long           |   | mask used to define visibility<br>= XV_COMBINE combine AOS/LOS elevations and physical mask (nominal mode)<br>= XV_AOS_LOS consider only AOS/LOS elevations<br>= XV_PHYSICAL consider only physical mask<br>= XV_FROM_FILE consider mask given in the Station Database File       |     | all                      |
| aos_elevation | double         |   | Minimum elevation to consider at AOS (i.e. before considering start of visibility).<br>Not used if mask=XV_FROM_FILE  | deg | ≥ 0.0                    |
| los_elevation | double         |   | Maximum elevation to consider at LOS (i.e. before considering end of visibility).<br>Not used if mask=XV_FROM_FILE  | deg | ≥ 0.0<br>≤ aos_elevation |
| min_duration  | double         |   | Minimum duration for segments.<br>Only segments with a duration longer than min_duration will be given on output.   | s   | ≥ 0.0                    |

*It is also possible to use enumeration values rather than integer values for some of the input arguments, as shown in the table below:*

| Input | Description                       | Enumeration value | long |
|-------|-----------------------------------|-------------------|------|
| mask  | Combine AOS/LOS and physical mask | XV_COMBINE        | 0    |
|       | Use only AOS/LOS                  | XV_AOS_LOS        | 1    |
|       | Use only physical mask            | XV_PHYSICAL       | 2    |

---

|  |                    |              |   |
|--|--------------------|--------------|---|
|  |                    |              |   |
|  | Use mask from file | XV_FROM_FILE | 3 |

## 7.5.4 Output parameters

Table 21: Output parameters of `xv_station_vis_time_no_file` function

| C name                                   | C type | Array Element | Description   | Unit (Format) | Allowed Range                          |
|--|--------|---------------|---|---------------|--|
| <code>xv_station_vis_time_no_file</code> | long   |               | Function status flag,<br>= 0 No error<br>> 0 Warnings, results generated<br>< 0 Error, no results generated   |               |  |
| <code>number_segments</code>             | long   |               | Number of visibility segments returned to the user  |               | $\geq 0$                               |
| <code>bgn_orbit</code>                   | long*  | all           | Orbit number,<br>begin of visibility segment <i>i</i><br><code>bgn_orbit[i-1]</code> ,<br><i>i</i> = 1, <code>number_segments</code>                  |               | > 0                                    |
| <code>bgn_second</code>                  | long*  | all           | Seconds since ascending node,<br>begin of visibility segment <i>i</i><br><code>bgn_second[i-1]</code> ,<br><i>i</i> = 1, <code>number_segments</code> | s             | $\geq 0$<br>< orbital period           |
| <code>bgn_microsec</code>                | long*  | all           | Micro seconds within second<br>begin of visibility segment <i>i</i><br><code>bgn_microsec[i-1]</code> ,<br><i>i</i> = 1, <code>number_segments</code> | $\mu$ s       | $\geq 0$<br>$\leq 999999$              |
| <code>bgn_cycle</code>                   | long*  | all           | Cycle number,<br>begin of visibility segment <i>i</i><br><code>bgn_cycle[i-1]</code> ,<br><i>i</i> = 1, <code>number_segments</code>                  |               | > 0<br>NULL when using absolute orbits |
| <code>end_orbit</code>                   | long*  | all           | Orbit number,<br>end of visibility segment <i>i</i><br><code>end_orbit[i-1]</code> ,<br><i>i</i> = 1, <code>number_segments</code>                    |               | > 0                                    |
| <code>end_second</code>                  | long*  | all           | Seconds since ascending node,<br>end of visibility segment <i>i</i><br><code>end_second[i-1]</code> ,<br><i>i</i> = 1, <code>number_segments</code>   | s             | $\geq 0$<br>< orbital period           |
| <code>end_microsec</code>                | long*  | all           | Micro seconds within second   | $\mu$ s       | $\geq 0$                               |

|   |       |     |  |    |   |
|---|-------|-----|--|----|---|
|   |       |     | end of visibility segment i<br>end_microsec[i-1],<br>i = 1, number_segments  |    | ≤ 999999                                    |
| end_cycle                                 | long* | all | Cycle number,<br>end of visibility segment i<br>end_cycle[i-1],<br>i = 1, number_segments  |    | >0<br>NULL when<br>using absolute<br>orbits |
| zdop_orbit                                | long* | all | Orbit number,<br>time of zero doppler (-1 if no zero<br>doppler within corresponding<br>visibility segment)<br>zdop_orbit[i-1],<br>i = 1, number_segments                  |    | > 0   |
| zdop_second                               | long* | all | Seconds since ascending node,<br>time of zero doppler (-1 if no zero<br>doppler within corresponding<br>visibility segment)<br>zdop_second[i-1],<br>i = 1, number_segments | s  | ≥ 0<br>< orbital<br>period                  |
| zdop_microsec                             | long* | all | Micro seconds within second<br>time of zero doppler (-1 if no zero<br>doppler within corresponding<br>visibility segment)<br>zdop_microsec[i-1],<br>i = 1, number_segments | μs | 0 =<br>=< 999999                            |
| zdop_cycle                                | long* | all | Cycle number,<br>time of zero doppler (-1 if no zero<br>doppler within corresponding<br>visibility segment)<br>zdop_second[i-1],<br>i = 1, number_segments                 |    | >0<br>NULL when<br>using absolute<br>orbits |
| ierr[XV_NUM_ER<br>R_STATION_VIS_<br>TIME] | long  |     | Error status flags   |    |   |

**Memory Management:** Note that the output visibility segments arrays are pointers to integers instead of static arrays. The memory for these dynamic arrays is allocated within the **xv\_station\_vis\_time\_no\_file** function. So the user will only have to declare those pointers but not to allocate memory for them. However, once the function has returned without error, the user will have the responsibility of freeing the memory for those pointers once they are not used.

### **7.5.5 Warnings and errors**

The error and warning messages and codes for `xv_station_vis_time_no_file` are the same than for `xv_station_vis_time` (see Table 19) .

The error messages/codes can be returned by the CFI function `xv_get_msg/xv_get_code` after translating the returned status vector into the equivalent list of error messages/codes. The function identifier to be used in that functions is `XV_STATION_VIS_TIME_ID` (from Table 2).

## 7.6 xv\_stationvistime\_compute

### 7.6.1 Overview

The **xv\_stationvistime\_compute** function computes ground station visibility segments, the orbital segments for which the satellite is visible from one or several ground stations located at the surface of the Earth.

An orbital segment is a time interval along the orbit, defined by start and stop times expressed as seconds elapsed since the ascending node crossing.

If more than one ground station is provided, the visibility segments are computed internally for each of them. Those segments are merged and ordered by start time. In the output visibility segments, it is listed the stations from which the satellite is visible in each segment.

In addition, **xv\_stationvistime\_compute** calculates for every visibility segment the time of zero-doppler (i.e. the time at which the range-rate to the station is zero). It is computed per station, in case several stations are used as input.

**xv\_stationvistime\_compute** requires access to several data structures and files to produce its results:

- the orbit\_id (xo\_orbit\_id) providing the orbital data. The orbit\_id can be initialized with the following data and files, also for precise propagation if applicable (see [ORBIT\_SUM]):
  - data for an orbital change
  - Orbit scenario files
  - Predicted orbit files
  - Orbit Event Files (**Note: Orbit Event File is deprecated, only supported for CRYOSAT mission**).
  - Restituted orbit files
  - DORIS Preliminary orbit files
  - DORIS Navigator files
  - TLE files

Note: if the orbit is initialized for precise propagation, the execution of the visibility function can be very slow. As alternative, a POF can be generated with the precise propagator (function xo\_gen\_pof) for the range of orbits the user usually needs, and use this generated file to initialize the orbit id. The execution time performance will be much better for the visibility function and it will not have a big impact on the precision of the calculations.

- The swath\_id (xv\_swath\_id, initialized using xv\_swath\_id\_init -section 7.32-), which provides the Instrument Swath data, describing the area seen by the relevant instrument all along the current orbit.
- The Station data (xv\_station\_info\_list), describing the location and the physical mask of each ground station, and the mask parameters for a list of spacecrafts from each station (considered only when mask 'from file' option is selected).

The time intervals (xv\_time\_interval) used by **xv\_stationvistime\_compute** can be expressed as UTC times or orbit times (orbit plus seconds and microseconds since ascending node). These intervals express the start time/orbit and last time/orbit for the computations.

In case the time intervals are expressed as orbits, they can be expressed as absolute orbit numbers or in relative orbit and cycle numbers.

The orbit representation (absolute or relative) for the output segments will be the same as in the input orbits. The output segments will contain UTC times and orbit times. Moreover, the segments will be ordered chronologically.

**NOTE:** If `xv_stationvistime_compute` is used with a range of orbits that includes an orbital change (e.g. change in the repeat cycle or cycle length), the behavior depends on the type of the data used to initialize the `swath_id` (via `xv_swath_id_init`, section 7.32):

• If a **swath template file** is used, `xv_stationvistime_compute` automatically will ignore the orbits that do not correspond with the template file (i.e. no visibility segments will be generated for those orbits), since swath template file is generated from a reference orbit with a particular geometry, so it is not valid for a different geometry.

• If a **swath definition file** is introduced, `xv_stationvistime_compute` will perform the computations across orbital changes, and will return the visibility segments corresponding to the whole orbital range. Internally, swath template files valid for every orbital change are generated to perform the calculations.

**NOTE 2:** If a swath template file with the variable header tags *Start\_VValidity\_Range* and *Stop\_VValidity\_Range* is used as input, only the segments belonging to that orbit range will be returned.

**NOTE 3:** If a swath definition file is introduced, it can be also introduced every how many orbits the swath template file must be recomputed (according to the number of regeneration orbits used in swath id initialization). If the orbit\_id has been initialized with an OSF file with MLST non linear terms and the number of regeneration orbits is greater than the linear approximation validity, the recomputation of swath template file will be done every linear approximation validity orbits.

## 7.6.2 Usage Hints

### 7.6.2.1 Use of input `xp_attitude_def_struct`

The definition of the input structure `xp_attitude_def` can be consulted in section 6.3 of [POINT\_SUM].

The “type” field defines how this struct is used, and it can take the following values:

- `XP_NONE_ATTITUDE`: no attitude defined in struct. In this case, when the Swath Template File must be computed internally, the attitudes defined in Swath Definition File are used.
- `XP_SAT_NOMINAL_ATT`, `XP_SAT_ATT`, `XP_INSTR_ATT`: the attitudes defined in the structure are used in internal Swath Template File generation. The “type” field in this case indicates the target frame for the computation.

### 7.6.2.2 Use of input `xv_station_info_list_struct`

The station or stations to be used in algorithm are passed to `xv_stationvistime_compute` function with the struct `xv_station_info_list` (see section 6.3 for description). It contains the following fields:

- *calc\_flag*: it can take the enumeration values `XV_COMPUTE` or `XV_DO_NOT_COMPUTE`. This flag indicates if the extra information regarding the stations (zero doppler time) must be computed or not.
- *num\_rec*: Indicates the number of input stations where the visibility is going to be computed.
- *station\_info*: description of the stations to be computed. Every position of the array is a `xv_station_info` struct. The value of *type* field indicates the type of station data:



- If *type* is equal to enum value `XV_USE_STATION_FILE`, then the station *station\_id* is read from *station\_db\_filename* station file. If AOS, LOS and mask are not defined in the file, the values are taken from the fields *default\_aos*, *default\_lo*s and *default\_mask*.
- If *type* is equal to enum value `XV_USE_STATION_FILE_AND_MASK_OVERRIDE`, then the station *station\_id* is read from *station\_db\_filename* station file. In this case, the values used in computations for AOS, LOS and mask are taken from the fields *default\_aos*, *default\_lo*s and *default\_mask*, not from the information read from station file.
- If *type* is equal to enum value `XV_USE_STATION_DATA`, then the information contained in *station\_data* field is used (see [D\_H\_SUM] for description of *xd\_station\_rec*). If AOS, LOS and mask are not defined in the struct, the values are taken from the fields *default\_aos*, *default\_lo*s and *default\_mask*.
- If *type* is equal to enum value `XV_USE_STATION_DATA_AND_MASK_OVERRIDE`, then the information contained in *station\_data* field is used (see [D\_H\_SUM] for description of *xd\_station\_rec*). In this case, the values used in computations for AOS, LOS and mask are taken from the fields *default\_aos*, *default\_lo*s and *default\_mask*, not from the information read from station file.
- *min\_duration*: indicates the minimum duration for the segments (seconds).

### 7.6.3 Calling interface

For C programs, the call to `xv_stationvistime_compute` is (input parameters are underlined):

```
#include"explorer_visibility.h"
{
    xo_orbit_id orbit_id = {NULL};
    xp_attitude_def attitude_def;
    xv_swath_id swath_id = {NULL};
    xv_station_info_list station_info_list;
    xv_time_interval search_interval;
    xv_stationvisibility_interval_list visibility_interval_list;
    long ierr[XV_NUM_ERR_STATIONVISTIME_COMPUTE];

    status = xv_stationvistime_compute(
        &orbit_id, &attitude_def,
        &swath_id, &station_info_list,
        &search_interval,
        &visibility_interval_list, ierr);
}
```

## 7.6.4 Input parameters

Table 22: Input parameters of `xv_stationvistime_compute`

| C name                         | C type                             | Array Element | Description (Reference)                                       | Unit (Format) | Allowed Range |
|--------------------------------|------------------------------------|---------------|---|---------------|---------------|
| <code>orbit_id</code>          | <code>xo_orbit_id*</code>          | -             | Structure that contains the orbit data                        | -             | -             |
| <code>attitude_def</code>      | <code>xp_attitude_def*</code>      | -             | Structure with the definition of the attitudes.               | -             | -             |
| <code>swath_id</code>          | <code>xv_swath_id*</code>          | -             | Swath id.   | -             | -             |
| <code>station_info_list</code> | <code>xv_station_info_list*</code> | -             | List of station where the visibility is going to be computed. | -             | -             |

It is also possible to use enumeration values rather than integer values for some of the input arguments, as shown in the table below:

| Input | Description                       | Enumeration value | long |
|-------|-----------------------------------|-------------------|------|
| mask  | Combine AOS/LOS and physical mask | XV_COMBINE        | 0    |
|       | Use only AOS/LOS                  | XV_AOS_LOS        | 1    |
|       | Use only physical mask            | XV_PHYSICAL       | 2    |
|       | Use mask from file                | XV_FROM_FILE      | 3    |

## 7.6.5 Output parameters

*Table 23: Output parameters of xv\_stationvistime\_compute function*

| C name                                    | C type                              | Array Element | Description   | Unit (Format) | Allowed Range |
|---|-------------------------------------|---------------|---|---------------|---------------|
| xv_station_vis_time                       | long                                |               | Function status flag,<br>= 0 No error<br>> 0 Warnings, results generated<br>< 0 Error, no results generated |               |               |
| visibility_interval_list                  | xv_stationvisibility_interval_list* | -             | List of visibility segments and additional information (zero doppler and station names)                     | -             | -             |
| ierr[XV_NUM_ERROR_STATIONVISTIME_COMPUTE] | long                                |               | Error status flags  |               |               |

Memory Management: Note that the output visibility segment list (xv\_stationvisibility\_interval\_list->visibility\_interval) is a pointer to the list of segments computed inside xv\_stationvistime\_compute. The memory for this dynamic array is allocated within the **xv\_stationvistime\_compute** function. So the user will only have to declare the variable xv\_stationvisibility\_interval\_list. However, once the function has returned without error, the user will have the responsibility of freeing the memory for the pointers inside that variable and the rest of structs inside xv\_station\_coverage\_info\_list struct.

### 7.6.6 Warnings and errors

Next table lists the possible error messages that can be returned by the `xv_stationvistime_compute` CFI function after translating the returned status vector into the equivalent list of error messages by calling the function of the EO\_VISIBILITY software library `xv_get_msg`.

This table also indicates the type of message returned, i.e. either a warning (WARN) or an error (ERR), the cause of such a message and the impact on the performed calculation, mainly on the results vector.

The table is completed by the error code and value. These error codes can be obtained translating the status vector returned by the `xv_stationvistime_compute` CFI function by calling the function of the EO\_VISIBILITY software library `xv_get_code`.

**Table 24: Error messages and codes for `xv_stationvistime_compute`**

| Error type | Error message  | Cause and impact          | Error Code   | Error No |
|------------|--|---------------------------|--|----------|
| ERR        | Input parameter \"Orbit Id\" is wrong.                           | Computation not performed | XV_CFI_STATIONVISTIME_COMPUTE_ORBIT_STATU<br>S_ERR     | 0        |
| ERR        | Geostationary satellite not allowed for this function.           | Computation not performed | XV_CFI_STATIONVISTIME_COMPUTE_GEO_SAT_ER<br>R          | 1        |
| ERR        | Swath id not initialized   | Computation not performed | XV_CFI_STATIONVISTIME_COMPUTE_SWATH_STATU<br>S_ERR     | 2        |
| ERR        | Error in input parameter to stavistime.                          | Computation not performed | XV_CFI_STATIONVISTIME_COMPUTE_INPUTS_CHEC<br>K_ERR     | 3        |
| ERR        | Input parameter \"orbit_type\" is out of range.                  | Computation not performed | XV_CFI_STATIONVISTIME_COMPUTE_ORBIT_TYPE_<br>ERR       | 4        |
| ERR        | Input parameter \"swath_flag\" is out of range.                  | Computation not performed | XV_CFI_STATIONVISTIME_COMPUTE_SWATH_FLAG_<br>ERR       | 5        |
| ERR        | Warning, start orbit is outside range of OSF.                    | Computation not performed | XV_CFI_STATIONVISTIME_COMPUTE_FIRST_ORBIT_<br>WARN     | 6        |
| ERR        | Error transforming start orbit from relative to absolute orbits. | Computation not performed | XV_CFI_STATIONVISTIME_COMPUTE_REL_TO_ABS_<br>START_ERR | 7        |
| ERR        | Actual stop orbit is earlier than actual start orbit.            | Computation not performed | XV_CFI_STATIONVISTIME_COMPUTE_WRONG_INTE<br>RVAL_ERR   | 8        |
| ERR        | Swath file is not compatible with the orbit file                 | Computation not performed | XV_CFI_STATIONVISTIME_COMPUTE_WRONG_SWA<br>TH_ERR      | 9        |

|      |   |   |   |    |
|------|---|---|---|----|
| ERR  | Error wrong swath type selected.  | Computation not performed                             | XV_CFI_STATIONVISTIME_COMPUTE_SWATH_TYPE_ERR                                  | 10 |
| ERR  | Error obtaining orbital information in orbit info .   | Computation not performed.                            | XV_CFI_STATIONVISTIME_COMPUTE_ORBIT_INFO_ERR                                  | 11 |
| ERR  | Orbital information does not coincide with reference swath.   | Computation not performed.                            | XV_CFI_STATIONVISTIME_COMPUTE_INCONSISTENT_SWATH_ERR                          | 12 |
| ERR  | Warning, there is an orbital change within the requested orbits .                                   | Computation not performed                             | XV_CFI_STATIONVISTIME_COMPUTE_ORBIT_CHANGE_WARN                               | 13 |
| ERR  | Error computing segments for one station  | Computation not performed                             | XV_CFI_STATIONVISTIME_COMPUTE_STA_COMPUTE_ERR                                 | 14 |
| ERR  | Error allocating memory for the time segments.  | Computation not performed.                            | XV_CFI_STATIONVISTIME_COMPUTE_SEGMENTS_MEMORY_ERR                             | 15 |
| ERR  | Error transforming from absolute to relative.   | Computation not performed                             | XV_CFI_STATIONVISTIME_COMPUTE_ABS_TO_REL_ERR                                  | 16 |
| ERR  | Wrong input Orbit Id. Unknown orbit initialization mode   | Computation not performed                             | XV_CFI_STATIONVISTIME_COMPUTE_ORBIT_MODEL_ERR                                 | 17 |
| ERR  | Error reading Swath File: %s  | Computation not performed                             | XV_CFI_STATIONVISTIME_COMPUTE_READ_SWATH_FILE_ERR                             | 18 |
| ERR  | Input orbit interval is completely outside STF validity interval                                    | Computation not performed                             | XV_CFI_STATIONVISTIME_COMPUTE_ORBIT_INTERVAL_STF_ERR                          | 19 |
| WARN | Input orbit interval is partially outside STF validity interval                                     | Computation performed.<br>Message to inform the user. | XV_CFI_STATIONVISTIME_COMPUTE_ORBIT_INTERVAL_STF_WARN                         | 20 |
| WARN | Input OSF has non-trivial MLST non linear terms but STF was generated without them                  | Computation performed.<br>Message to inform the user. | XV_CFI_STATIONVISTIME_COMPUTE_OSF_NON_LINEAR_STF_OLD_WARN                     | 21 |
| ERR  | Error computing overlap for multistations   | Computation not performed                             | XV_CFI_STATIONVISTIME_COMPUTE_OVERLAP_ERR                                     | 22 |
| WARN | Swath flag larger than MLST linear approximation validity. MLST linear approximation validity used. | Computation performed.<br>Message to inform the user. | XV_CFI_STATIONVISTIME_COMPUTE_SWATH_FLAG_LARGER_THAN_LINEAR_APPROX_VALID_WARN | 23 |
| ERR  | Error transforming time to orbit  | Computation not performed.                            | XV_CFI_STATIONVISTIME_COMPUTE_TIME_TO_ORBIT_ERR                               | 24 |

|      |  |                            |   |    |
|------|--|----------------------------|---|----|
| ERR  | Error checking output segments                                   | Computation not performed  | XV_CFI_STATIONVISTIME_COMPUTE_CHECK_SEGMENTS_ERR    | 25 |
| ERR  | Error computing UTC time   | Computation not performed. | XV_CFI_STATIONVISTIME_COMPUTE_GET_UTCTIME_ERR       | 26 |
| ERR  | Input file is not a swath file                                   | Computation not performed  | XV_CFI_STATIONVISTIME_COMPUTE_DETECT_SWATH_TYPE_ERR | 32 |
| WARN | Visibility computations with precise propagator can be very slow | Computation performed      | XV_CFI_STATIONVISTIME_COMPUTE_PRECISE_PROPAG_WARN   | 33 |

## 7.7 xv\_sc\_vis\_time

### 7.7.1 Overview

The **xv\_sc\_vis\_time** function computes all the orbital segments for which Communication Terminal of a target satellite (LEO or GEO) is visible from Communication Terminal of a source satellite (LEO).

An orbital segment is a time interval along the orbit, defined by start and stop times expressed as seconds elapsed since the ascending node crossing.

**xv\_sc\_vis\_time** requires access to the orbit\_id (xo\_orbit\_id) data structure of both satellites. For orbit id initialization please refer to [ORBIT\_SUM].

Note: if the orbit is initialized for precise propagation, the execution of the visibility function can be very slow. As alternative, a POF can be generated with the precise propagator (function xo\_gen\_pof) for the range of orbits the user usually needs, and use this generated file to initialize the orbit id. The execution time performance will be much better for the visibility function and it will not have a big impact on the precision of the calculations.

The time intervals used by **xv\_sc\_vis\_time** are expressed in absolute or relative orbit numbers (with respect to source satellite). This is valid for both:

- input parameter “Orbit Range”: first and last orbit to be considered. In case of using relative orbits, the corresponding cycle number should be used, otherwise, this the cycle number will be a dummy parameter.
- output parameter “Target Satellite Visibility Segments”: time segments with time expressed as {absolute orbit number (or relative orbit and cycle number), number of seconds since ANX, number of microseconds}

The orbit representation (absolute or relative) for the output segments will be the same as in the input orbits. Moreover, the segments will be ordered chronologically.

Users who need to use processing times must make use of the conversion routines provided in [ORBIT\_SUM] (**xo\_time\_to\_orbit** and **xv\_orbit\_to\_time** functions).

The **xv\_sc\_vis\_time** function considers the following sources of occultation, which can be configured through xv\_link\_data input struct:

- Earth plus a minimum tangent height.
- Satellite inclusive and exclusive masks, which are zones of azimuth and elevation where visibility is possible (inclusive mask) or not possible (exclusive mask). These masks can be used to model constraints (e.g. mechanical) or occlusion of the field of view.

In the following figure, the behaviour of the mask is explained. The four mask combinations are represented:

- Inclusive mask **disabled**, exclusive mask **disabled**.
- Inclusive mask **enabled**, exclusive mask **disabled**.
- Inclusive mask **disabled**, exclusive mask **enabled**.
- Inclusive mask **enabled**, exclusive mask **enabled**.



In every case, the full field of view is represented. The internal rectangle represents the inclusive mask and the internal ellipse represents the exclusive mask. In every case, the zone in orange colour background is the field of view allowed by the enabled masks.

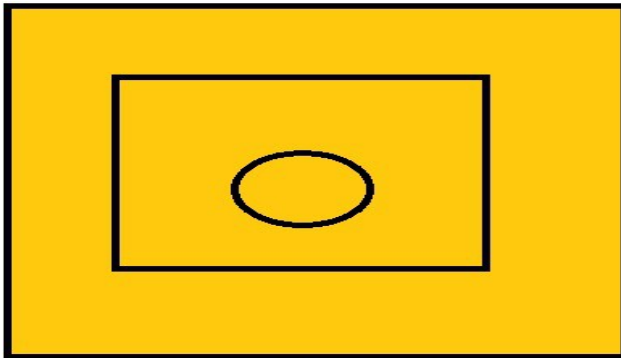

**inclusive mask disabled  
 exclusive mask disabled**

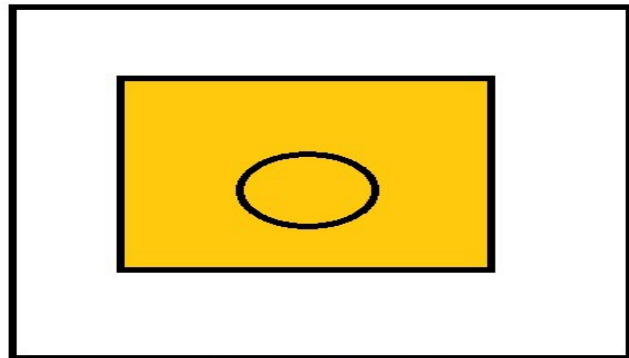

**inclusive mask enabled  
 exclusive mask disabled**

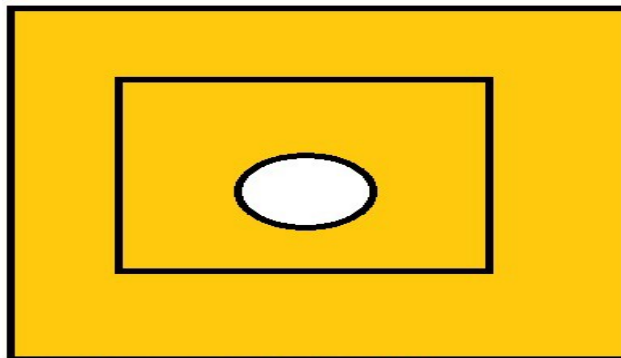

**inclusive mask disabled  
 exclusive mask enabled**

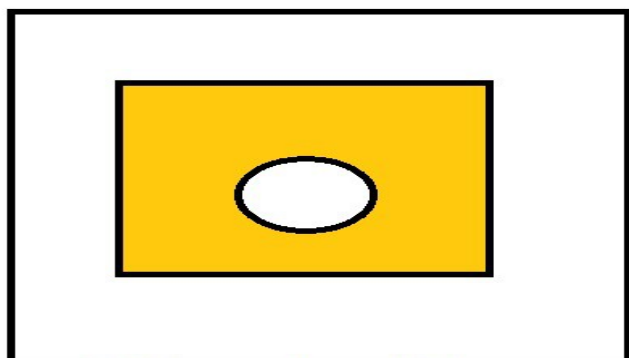

**inclusive mask enabled  
 exclusive mask enabled**

Notes about definition of masks:

- The masks are defined as closed zones.
- These zones are defined in the input struct `xv_link_data` with arrays of azimuth and elevation points that define a polygon in the azimuth-elevation plane (last point in array is closed with first point in array internally).
- It must be distinguished between azimuth = 0. deg and azimuth = 360. deg, since they are considered different in the azimuth-elevation plane; this has been done to make the definition of masks easier.
- The masks are enabled or disabled using the field status of `xv_az_el_mask` struct, setting its value to `XP_TRUE` or `XP_FALSE` respectively.

## 7.7.2 Calling interface

For C programs, the call to `xv_sc_vis_time` is (input parameters are underlined):

```
#include "explorer_visibility.h"
{
    xo_orbit_id orbit_id1 = {NULL};
    xo_orbit_id orbit_id2 = {NULL};
    xp_sat_nom_trans_id sat_nom_trans_id1 = {NULL};
```

```
xp_sat_nom_trans_id sat_nom_trans_id2 = {NULL};
xp_sat_trans_id     sat_trans_id1 = {NULL};
xp_sat_trans_id     sat_trans_id2 = {NULL};
xp_instr_trans_id   instr_trans_id1 = {NULL};
xp_instr_trans_id   instr_trans_id2 = {NULL};
long                orbit_type,
                   start_orbit, start_cycle,
                   stop_orbit, stop_cycle,
                   number_segments,
                   *bgn_orbit, *bgn_second,
                   *bgn_microsec, *bgn_cycle,
                   *end_orbit, *end_second,
                   *end_microsec, *end_cycle,
                   ierr[XV_NUM_ERR_SC_VIS_TIME],
                   status;
double              min_duration;
xv_link_data        link_data;

status = xv_sc_vis_time(
    &orbit_id1, &sat_nom_trans_id1,
    &sat_trans_id1, &instr_trans_id1, &orbit_type,
    &start_orbit, &start_cycle,
    &stop_orbit, &stop_cycle,
    &orbit_id2, &sat_nom_trans_id2,
    &sat_trans_id2, &instr_trans_id2,
    &link_data, &min_duration,
    &number_segments,
    &bgn_orbit, &bgn_second,
    &bgn_microsec, &bgn_cycle,
    &end_orbit, &end_second,
    &end_microsec, &end_cycle,
    ierr);

/* Or, using the run_id */
long run_id1, run_id2;

status = xv_sc_vis_time_run(
    &run_id1, &run_id2, &orbit_type,
    &start_orbit, &start_cycle,
    &stop_orbit, &stop_cycle,
    &link_data, &min_duration,
    &number_segments,
```

```
        &bgn_orbit, &bgn_second,  
        &bgn_microsec, &bgn_cycle,  
        &end_orbit, &end_second,  
        &end_microsec, &end_cycle,  
        ierr);  
}
```

### 7.7.3 Input parameters

Table 25: Input parameters of xv\_sc\_vis\_time

| C name            | C type               | Array Element | Description  | Unit (Format)                     | Allowed Range   |
|-------------------|----------------------|---------------|--|-----------------------------------|---|
| orbit_id1         | xo_orbit_id*         | -             | Structure that contains the orbit data of the source satellite   | -                                 | -   |
| sat_nom_trans_id1 | xp_sat_nom_trans_id* | -             | Structure that contains the Sat. Nom. Trans. of the source satellite   | -                                 | -   |
| sat_trans_id1     | xp_sat_trans_id*     | -             | Structure that contains the Sat. Trans. of the source satellite  | -                                 | -   |
| instr_trans_id1   | xp_instr_trans_id*   | -             | Structure that contains the Instr. Trans. of the source satellite  | -                                 | -   |
| orbit_type        | long                 | -             | Define the type of orbit representation, i.e. absolute or relative orbits in the input/output parameters   | -                                 | Complete  |
| start_orbit       | long                 | -             | <p>First orbit, segment filter.</p> <p>Segments will be filtered as from the beginning of first orbit (within orbit range from orbit_scenario_file)</p> <p>First Orbit in the orbit_scenario_file will be used when:</p> <ul style="list-style-type: none"> <li>Absolute orbit is set to zero.</li> <li>Relative orbit and cycle number set to zero.</li> </ul>  | absolute or relative orbit number | <p>= 0</p> <p>or:</p> <ul style="list-style-type: none"> <li>absolute orbits <math>\geq</math> start_osf</li> <li>relative orbits <math>\leq</math> repeat cycle</li> </ul> |
| start_cycle       | long                 | -             | Cycle number corresponding to the start_orbit. Dummy when using relative orbits  | cycle number                      | <p>= 0 or</p> <p><math>\leq</math> first cycle in osf</p>   |
| stop_orbit        | long                 | -             | <p>Last orbit, segment filter.</p> <p>When:</p> <ul style="list-style-type: none"> <li>stop_orbit = 0 (for orbit_type = XV_ORBIT_ABS)</li> <li>stop_orbit = 0 and stop_cycle = 0 (for orbit_type = XV_ORBIT_REL)</li> </ul> <p>the stop_orbit will be set to the minimum value between:</p> <ul style="list-style-type: none"> <li>the last orbit within the orbital change of the start_orbit.</li> <li>start_orbit+cycle_length-1 (i.e. the input orbit range will be a</li> </ul> | absolute or relative orbit number | <p>= 0</p> <p>or:</p> <ul style="list-style-type: none"> <li>absolute orbits <math>\geq</math> start_osf</li> <li>relative orbits <math>\leq</math> repeat cycle</li> </ul> |

|                   |                      |   | complete cycle)   |   |   |
|-------------------|----------------------|---|---|---|---|
| stop_cycle        | long                 | - | Cycle number corresponding to the stop_orbit. Dummy when using relative orbits                                    | cycle number  | = 0 or $\leq$ first cycle in osf  |
| orbit_id2         | xo_orbit_id*         | - | Structure that contains the orbit data of the target satellite  | -   | -   |
| sat_nom_trans_id2 | xp_sat_nom_trans_id* | - | Structure that contains the Sat. Nom. Trans. of the source satellite  | -   | -   |
| sat_trans_id2     | xp_sat_trans_id*     | - | Structure that contains the Sat. Trans. of the target satellite   | -   | -   |
| instr_trans_id2   | xp_instr_trans_id*   | - | Structure that contains the Instr. Trans. of the target satellite   | -   | -   |
| link_data         | xv_link_data*        | - | Link data (minimum tangent height and masks)  | [m] for minimum height<br>[deg] for azimuth and elevation | Height $\geq$ 0.<br>Azimuth range: [0., 360.]<br>Elevation range: [-90., 90.] |
| min_duration      | double               | - | Minimum duration for segments.<br>Only segments with a duration longer than min_duration will be given on output. | s   | $\geq$ 0.0  |

## 7.7.4 Output parameters

Table 26: Output parameters of *xv\_sc\_vis\_time* function

| C name                 | C type | Array Element | Description  | Unit (Format) | Allowed Range                          |
|------------------------|--------|---------------|--|---------------|--|
| <i>xv_sc_vis_time</i>  | long   |               | Function status flag,<br>= 0 No error<br>> 0 Warnings, results generated<br>< 0 Error, no results generated  |               |  |
| <i>number_segments</i> | long   |               | Number of visibility segments returned to the user   |               | ≥ 0                                    |
| <i>bgn_orbit</i>       | long*  | all           | Orbit number,<br>begin of visibility segment <i>i</i><br><i>bgn_orbit</i> [ <i>i</i> -1],<br><i>i</i> = 1, <i>number_segments</i>                  |               | > 0                                    |
| <i>bgn_second</i>      | long*  | all           | Seconds since ascending node,<br>begin of visibility segment <i>i</i><br><i>bgn_second</i> [ <i>i</i> -1],<br><i>i</i> = 1, <i>number_segments</i> | s             | ≥ 0<br>< orbital period                |
| <i>bgn_microsec</i>    | long*  | all           | Micro seconds within second<br>begin of visibility segment <i>i</i><br><i>bgn_microsec</i> [ <i>i</i> -1],<br><i>i</i> = 1, <i>number_segments</i> | ms            | ≥ 0<br>≤ 999999                        |
| <i>bgn_cycle</i>       | long*  | all           | Cycle number,<br>begin of visibility segment <i>i</i><br><i>bgn_cycle</i> [ <i>i</i> -1],<br><i>i</i> = 1, <i>number_segments</i>                  |               | > 0<br>NULL when using absolute orbits |
| <i>end_orbit</i>       | long*  | all           | Orbit number,<br>end of visibility segment <i>i</i><br><i>end_orbit</i> [ <i>i</i> -1],<br><i>i</i> = 1, <i>number_segments</i>                    |               | > 0                                    |
| <i>end_second</i>      | long*  | all           | Seconds since ascending node,<br>end of visibility segment <i>i</i><br><i>end_second</i> [ <i>i</i> -1],<br><i>i</i> = 1, <i>number_segments</i>   | s             | ≥ 0<br>< orbital period                |
| <i>end_microsec</i>    | long*  | all           | Micro seconds within second  | ms            | ≥ 0                                    |

|                                  |       |     |   |  |   |
|----------------------------------|-------|-----|---|--|---|
|                                  |       |     | end of visibility segment i<br>end_microsec[i-1],<br>i = 1, number_segments                 |  | ≤ 999999                                    |
| end_cycle                        | long* | all | Cycle number,<br>begin of visibility segment i<br>bgn_cycle[i-1],<br>i = 1, number_segments |  | >0<br>NULL when<br>using absolute<br>orbits |
| ierr[XV_NUM_E<br>RR_SC_VIS_TIME] | long  |     | Error status flags  |  |   |

Memory Management: Note that the output visibility segments arrays are pointers to integers instead of static arrays. The memory for these dynamic arrays is allocated within the **xv\_sc\_vis\_time** function. So the user will only have to declare those pointers but not to allocate memory for them. However, once the function has returned without error, the user will have the responsibility of freeing the memory for those pointers once they are not used.

## 7.7.5 Warnings and errors

Next table lists the possible error messages that can be returned by the `xv_sc_vis_time` CFI function after translating the returned status vector into the equivalent list of error messages by calling the function of the EO\_VISIBILITY software library `xv_get_msg`.

This table also indicates the type of message returned, i.e. either a warning (WARN) or an error (ERR), the cause of such a message and the impact on the performed calculation, mainly on the results vector.

The table is completed by the error code and value. These error codes can be obtained translating the status vector returned by the `xv_sc_vis_time` CFI function by calling the function of the EO\_VISIBILITY software library `xv_get_code`.

**Table 27: Error messages of `xv_sc_vis_time`**

| Error type | Error message   | Cause and impact         | Error Code                                | Error No |
|------------|---|--------------------------|---|----------|
| ERR        | Error allocating internal memory.   | No computation performed | XV_CFI_SC_VIS_TIME_INTERNAL_MEMORY_ERR    | 0        |
| ERR        | Wrong input orbit Id.   | No computation performed | XV_CFI_SC_VIS_TIME_ORBIT_STATUS_ERR       | 1        |
| ERR        | Error in input parameters.  | No computation performed | XV_CFI_SC_VIS_TIME_XV_SC_INPUTS_CHECK_ERR | 2        |
| ERR        | Input parameter "orbit_type" is out of range.                                     | No computation performed | XV_CFI_SC_VIS_TIME_ORBIT_TYPE_ERR         | 3        |
| WARN       | Input "start_orbit" below first OSF orbit: take first OSF orbit for computations. | Computation performed    | XV_CFI_SC_VIS_TIME_START_ORBIT_WARN       | 4        |
| ERR        | Error in absolute start orbit computation.  | No computation performed | XV_CFI_SC_VIS_TIME_REL_TO_ABS_START_ERR   | 5        |
| ERR        | Error in absolute stop orbit computation.   | No computation performed | XV_CFI_SC_VIS_TIME_REL_TO_ABS_STOP_ERR    | 6        |
| ERR        | Wrong orbit range.  | No computation performed | XV_CFI_SC_VIS_TIME_WRONG_ORBIT_RANGE_ERR  | 7        |
| ERR        | Error in orbit parameters computation. Orbit no: (%ld).                           | No computation performed | XV_CFI_SC_VIS_TIME_XV_ORBIT_INFO_ERR      | 8        |
| ERR        | Error performing a time transformation.   | No computation performed | XV_CFI_SC_VIS_TIME_TIME_CHANGE_ERR        | 9        |
| ERR        | Error checking the visibility.  | No computation performed | XV_CFI_SC_VIS_TIME_VISIBILITY_CHECK_ERR   | 10       |
| WARN       | First orbit starts with visibility.   | Computation performed    | XV_CFI_SC_VIS_TIME_FIRST_ORBIT_VIS_WARN   | 11       |



|      |  |                          |  |    |
|------|--|--------------------------|--|----|
| ERR  | Maximum number of iterations. Orbit no: (%ld).                   | No computation performed | XV_CFI_SC_VIS_TIME_MAX_NUMBER_ITER_ERR     | 12 |
| ERR  | Error in time computations. Orbit no: (%ld).                     | No computation performed | XV_CFI_SC_VIS_TIME_XV_TIME_SEC_ERR         | 13 |
| ERR  | Error transforming absolute to relative begin segments.          | No computation performed | XV_CFI_SC_VIS_TIME_ABS_TO_REL_BGN_ERR      | 14 |
| ERR  | Error transforming absolute to relative end segments.            | No computation performed | XV_CFI_SC_VIS_TIME_ABS_TO_REL_END_ERR      | 15 |
| WARN | Last orbit ends with visibility                                  | Computation performed    | XV_CFI_SC_VIS_TIME_LAST_ORBIT_VIS_WARN     | 16 |
| ERR  | Wrong satellite nominal attitude Id.                             | No computation performed | XV_CFI_SC_VIS_TIME_SAT_NOM_ATT_STATUS_ERR, | 17 |
| ERR  | Wrong satellite attitude Id.                                     | No computation performed | XV_CFI_SC_VIS_TIME_SAT_ATT_STATUS_ERR      | 18 |
| ERR  | Wrong instrument attitude Id.                                    | No computation performed | XV_CFI_SC_VIS_TIME_INSTR_ATT_STATUS_ERR    | 19 |
| WARN | Visibility computations with precise propagator can be very slow | Computation performed    | XV_CFI_SC_VIS_TIME_PRECISE_PROPAG_WARN     | 20 |

## 7.8 xv\_swath\_pos

### 7.8.1 Overview

**Note:** this function is deprecated. Use `xv_swathpos_compute` instead.

The `xv_swath_pos` function computes the location of a swath at a given time.

Swath location is expressed as<sup>1</sup>:

- longitude
- latitude
- altitude

for  $n$  points (with  $n \geq 1$ ). In Figure 2 we can see an example.

`xv_swath_pos` requires access to several data structures and files to produce its results:

- the `orbit_id` (`xo_orbit_id`) providing the orbital data. The `orbit_id` can be initialized with the following data and files, also with precise propagation if applicable (see [ORBIT\_SUM]):
  - data for an orbital change
  - Orbit scenario files
  - Predicted orbit files
  - Orbit Event Files (**Note: Orbit Event File is deprecated, only supported for CRYOSAT mission**)

<sup>1</sup> For inertial swaths, right ascension and declination are used instead of longitude and latitude

- Restituted orbit files
- DORIS Preliminary orbit files
- DORIS Navigator files
- TLE file
- the Instrument Swath data, describing the area seen by the relevant instrument all along the current orbit. The swath file is produced off-line by the EO\_VISIBILITY library (**xv\_gen\_swath** function) and the data structure can be got by reading the file with **xd\_read\_stf**.

The input time used by **xv\_swath\_pos** is expressed in orbit-relative time.

Users who need to use processing time must make use of the conversion routine provided in EO\_VISIBILITY (**xv\_time\_to\_orbit** and **xv\_orbit\_to\_time** functions).

**NOTE:** Since the swath template file is generated from a reference orbit, it is not allowed to use **xv\_swath\_pos** for an orbit in the orbit scenario file with different repeat cycle or cycle length. If this would happen, **xv\_swath\_pos** will return an error and no computation will be performed.

## 7.8.2 Calling sequence of `xv_swath_pos`

For C programs, the call to `xv_swath_pos` is (input parameters are underlined):

```
#include "explorer_visibility.h"
{
    xo_orbit_id  orbit_id = {NULL};
    long         orbit_type,
                orbit, second, microsec, cycle,
                ierr[XV_NUM_ERR_SWATH_POS], status;
    double      *longitude, *latitude, *altitude;
    xd_stf_file  stf_data;

    status = xv_swath_pos(&orbit_id,
                        &stf_data,
                        &orbit_type,
                        &orbit, &second, &microsec, &cycle,
                        longitude, latitude, altitude,
                        ierr);

    /* Or, using the run_id */
    long run_id;

    status = xv_swath_pos_run(&run_id,
                            &stf_data,
                            &orbit_type,
                            &orbit, &second, &microsec, &cycle,
                            longitude, latitude, altitude,
                            ierr);
}
```

### 7.8.3 Input parameters *xv\_swath\_pos*

Table 28: Input parameters of *xv\_swath\_pos*

| C name     | C type       | Array Element | Description  | Unit (Format) | Allowed Range            |
|------------|--------------|---------------|--|---------------|--------------------------|
| orbit_id   | xo_orbit_id* | -             | Structure that contains the orbit data   | -             | -                        |
| stf_data   | xd_stf_file  |               | Swath Template data structure  | -             | -                        |
| orbit_type | long         | -             | Define the type of orbit representation, i.e. absolute or relative orbits in the input/output parameters | -             | Complete                 |
| orbit      | long         |               | Orbit number   |               | > 0                      |
| second     | long         |               | Seconds since ascending node   | s             | >= 0<br>< orbital period |
| microsec   | long         |               | Micro seconds within second  | ms            | 0 =<<br>=< 999999        |
| cycle      | long         |               | Cycle number   |               | >0                       |

### 7.8.4 Output parameters *xv\_swath\_pos*

Table 29: Output parameters of *xv\_swath\_pos*

| C name              | C type  | Array Element | Description  | Unit (Format) | Allowed Range |
|---------------------|---------|---------------|--|---------------|---------------|
| <i>xv_swath_pos</i> | long    |               | Function status flag,<br>= 0 No error<br>> 0 Warnings, results generated<br>< 0 Error, no results generated  |               |               |
| longitude           | double* | all           | longitude (right ascension for inertial swaths) of points of the swath.<br><br>The user must reserve as many array positions as the number of points of the instantaneous swath. | deg           | [-180, 180]   |
| latitude            | double* | all           | latitude (declination for inertial swaths) of points of the swath.   | deg           | [-90, 90]     |

|                            |         |     |   |   |  |
|----------------------------|---------|-----|---|---|--|
|                            |         |     | The user must reserve as many array positions as the number of points of the instantaneous swath.   |   |  |
| altitude                   | double* | all | altitude of point is of the swath.<br><br>The user must reserve as many array positions as the number of points of the instantaneous swath. | m |  |
| ierr[XV_NUM_ERR_SWATH_POS] | long    |     | Error status flags  |   |  |

## 7.8.5 Warnings and errors

Next table lists the possible error messages that can be returned by the **xv\_swath\_pos** CFI function after translating the returned status vector into the equivalent list of error messages by calling the function of the EO\_VISIBILITY software library **xv\_get\_msg**.

This table also indicates the type of message returned, i.e. either a warning (WARN) or an error (ERR), the cause of such a message and the impact on the performed calculation, mainly on the results vector.

The table is completed by the error code and value. These error codes can be obtained translating the status vector returned by the **xv\_swath\_pos** CFI function by calling the function of the EO\_VISIBILITY software library **xv\_get\_code**.

**Table 30: Error messages and codes**

| Error type | Error message  | Cause and impact          | Error Code                              | Error No |
|------------|--|---------------------------|---|----------|
| ERR        | Wrong orbit Id.  | Computation not performed | XV_CFI_SWATH_POS_ORBIT_STATUS_ERR       | 0        |
| ERR        | Wrong input Orbit Id.<br>Unknown orbit initialization mode               | Computation not performed | XV_CFI_SWATH_POS_ORBIT_MODEL_ERR        | 1        |
| ERR        | Orbital information does not coincide with reference swath.              | Computation not performed | XV_CFI_SWATH_POS_INCONSISTENT_SWATH_ERR | 2        |
| ERR        | Orbit number must be positive.   | Computation not performed | XV_CFI_SWATH_POS_ORB_NUM_LIM_ERR        | 3        |
| ERR        | Seconds since ascending node must be zero or positive.                   | Computation not performed | XV_CFI_SWATH_POS_SEC_LIM_ERR            | 4        |
| ERR        | MicroSeconds must be zero or positive                                    | Computation not performed | XV_CFI_SWATH_POS_MICROSEC_1ST_ERR       | 5        |
| ERR        | MicroSeconds can not be bigger than 999999.                              | Computation not performed | XV_CFI_SWATH_POS_MICROSEC_2ND_ERR       | 6        |
| ERR        | Orbit type switch out of range.  | Computation not performed | XV_CFI_SWATH_POS_ORBIT_TYPE_ERR         | 7        |
| ERR        | Cycle number must be positive.   | Computation not performed | XV_CFI_SWATH_POS_CYCLE_ERR              | 8        |
| ERR        | Orbit number is not included in the Orbit Scenario File                  | Computation not performed | XV_CFI_SWATH_POS_ORB_NUM_OEF_ERR        | 9        |
| ERR        | Input time greater than orbital period.                                  | Computation not performed | XV_CFI_SWATH_POS_TIME_ERR               | 10       |
| ERR        | Repeat Days Cycle of this orbit is not the same than the swath template. | Computation not performed | XV_CFI_SWATH_POS_REP_CYCLE_ERR          | 11       |

|      |   |                           |                                    |    |
|------|---|---------------------------|------------------------------------|----|
| ERR  | Orbits Cycle Length of this orbit is not the same than the swath template | Computation not performed | XV_CFI_SWATH_POS_CYCLE_LENGTH_ERR  | 12 |
| ERR  | MLST drift of this orbit is not the same than the swath template.         | Computation not performed | XV_CFI_SWATH_POS_MLST_DRIFT_ERR    | 13 |
| ERR  | No spherical triangle.  | Computation not performed | XV_CFI_SWATH_POS_SPHER_TRIANG_ERR  | 14 |
| ERR  | Error while transforming from relative to absolute orbit.                 | Computation not performed | XV_CFI_SWATH_POS_REL_TO_ABS_ERR    | 15 |
| ERR  | Error while computing information of the orbit.                           | Computation not performed | XV_CFI_SWATH_POS_XV_ORBIT_INFO_ERR | 16 |
| ERR  | The swath template structure contains invalid data                        | Computation not performed | XV_CFI_SWATH_POS_SWATH_INIT_ERR    | 17 |
| ERR  | Error allocating internal memory.   | Computation not performed | XV_CFI_SWATH_POS_MEMORY_ERR        | 18 |
| ERR  | Geostationary satellite not allowed for this function.                    | Computation not performed | XV_CFI_SWATH_POS_GEO_SAT_ERR       | 19 |
| WARN | Deprecated function. Use xv_swathpos_compute instead                      | Computation performed     | XV_CFI_SWATH_POS_DEPRECATED_WARN   | 20 |

## 7.9 xv\_swathpos\_compute

### 7.9.1 Overview

The **xv\_swathpos\_compute** function computes the location of a swath at a given time.

Swath location is expressed as<sup>2</sup>:

- longitude
- latitude
- altitude

for  $n$  points (with  $n \geq 1$ ). In Figure 2 we can see an example.

**xv\_swathpos\_compute** requires access to several data structures and files to produce its results:

- the **orbit\_id** (**xo\_orbit\_id**) providing the orbital data. The **orbit\_id** can be initialized with the following data and files, also with precise propagation if applicable (see [ORBIT\_SUM]):
  - data for an orbital change
  - Orbit scenario files
  - Predicted orbit files
  - Orbit Event Files (**Note: Orbit Event File is deprecated, only supported for CRYOSAT mission**)
  - Restituted orbit files
  - DORIS Preliminary orbit files
  - DORIS Navigator files
  - TLE file
- the **swath\_id** (**xv\_swath\_id**, initialized using **xv\_swath\_id\_init** -section 7.32-), providing the Instrument Swath information. If the **swath\_id** is initialized with a Swath definition file or Swath definition data, **xv\_swathpos\_compute** generates the swath points for the orbit corresponding to input time.

The input time used by **xv\_swathpos\_compute** is expressed in orbit-relative time.

Users who need to use processing time must make use of the conversion routine provided in EO\_VISIBILITY (**xv\_time\_to\_orbit** and **xv\_orbit\_to\_time** functions).

**NOTE:** Since the swath template file is generated from a reference orbit, it is not allowed to use **xv\_swathpos\_compute** for an orbit in the orbit scenario file with different repeat cycle or cycle length. If this would happen, **xv\_swathpos\_compute** will return an error and no computation will be performed.

---

2 For inertial swaths, right ascension and declination are used instead of longitude and latitude



## 7.9.2 Calling sequence of `xv_swathpos_compute`

For C programs, the call to `xv_swathpos_compute` is (input parameters are underlined):

```
#include "explorer_visibility.h"
{
    xo_orbit_id orbit_id = {NULL};
    xv_swath_id  swath_id = {NULL};
    xv_time      swathpos_time;
    xv_swath_point_list swath_point_list;
    long ierr[XV_NUM_ERR_SWATHPOS_COMPUTE];

    status = xv_swathpos_compute(&orbit_id,
                                &swath_id, &swathpos_time,
                                &swath_point_list, ierr);
}
```

### 7.9.3 Input parameters *xv\_swathpos\_compute*

Table 31: Input parameters of *xv\_swathpos\_compute*

| C name        | C type       | Array Element | Description                            | Unit (Format) | Allowed Range |
|---------------|--------------|---------------|--|---------------|---------------|
| orbit_id      | xo_orbit_id* | -             | Structure that contains the orbit data | -             | -             |
| swath_id      | xv_swath_id* | -             | Swath id                               | -             | -             |
| swathpos_time | xv_time*     | -             | Input time/orbit for computation.      |               |               |

### 7.9.4 Output parameters *xv\_swathpos\_compute*

Table 32: Output parameters of *xv\_swathpos\_compute*

| C name                            | C type               | Array Element | Description   | Unit (Format) | Allowed Range |
|-----------------------------------|----------------------|---------------|---|---------------|---------------|
| <i>xv_swathpos_compute</i>        | long                 |               | Function status flag,<br>= 0 No error<br>> 0 Warnings, results generated<br>< 0 Error, no results generated |               |               |
| swath_point_list                  | xv_swath_point_list* | -             | Geodetic information of swath points.   |               |               |
| ierr[XV_NUM_ERR_SWATHPOS_COMPUTE] | long                 |               | Error status flags  |               |               |

## 7.9.5 Warnings and errors

Next table lists the possible error messages that can be returned by the **xv\_swathpos\_compute** CFI function after translating the returned status vector into the equivalent list of error messages by calling the function of the EO\_VISIBILITY software library **xv\_get\_msg**.

This table also indicates the type of message returned, i.e. either a warning (WARN) or an error (ERR), the cause of such a message and the impact on the performed calculation, mainly on the results vector.

The table is completed by the error code and value. These error codes can be obtained translating the status vector returned by the **xv\_swathpos\_compute** CFI function by calling the function of the EO\_VISIBILITY software library **xv\_get\_code**.

**Table 33: Error messages and codes**

| Error type | Error message   | Cause and impact          | Error Code                                     | Error No |
|------------|---|---------------------------|--|----------|
| ERR        | Wrong orbit Id.   | Computation not performed | XV_CFI_SWATHPOS_COMPUTE_ORBIT_STATUS_ERR       | 0        |
| ERR        | Wrong input Orbit Id.<br>Unknown orbit initialization mode  | Computation not performed | XV_CFI_SWATHPOS_COMPUTE_ORBIT_MODEL_ERR        | 1        |
| ERR        | Orbital information does not coincide with reference swath. | Computation not performed | XV_CFI_SWATHPOS_COMPUTE_INCONSISTENT_SWATH_ERR | 2        |
| ERR        | Orbit number must be positive.                              | Computation not performed | XV_CFI_SWATHPOS_COMPUTE_ORB_NUM_LIM_ERR        | 3        |
| ERR        | Seconds since ascending node must be zero or positive.      | Computation not performed | XV_CFI_SWATHPOS_COMPUTE_SEC_LIM_ERR            | 4        |
| ERR        | MicroSeconds must be zero or positive.                      | Computation not performed | XV_CFI_SWATHPOS_COMPUTE_MICROSEC_1ST_ERR       | 5        |
| ERR        | MicroSeconds can not be bigger than 999999.                 | Computation not performed | XV_CFI_SWATHPOS_COMPUTE_MICROSEC_2ND_ERR       | 6        |
| ERR        | Orbit type switch out of range.                             | Computation not performed | XV_CFI_SWATHPOS_COMPUTE_ORBIT_TYPE_ERR         | 7        |
| ERR        | Cycle number must be positive.                              | Computation not performed | XV_CFI_SWATHPOS_COMPUTE_CYCLE_ERR              | 8        |
| ERR        | Orbit number is not included in the Orbit Scenario File.    | Computation not performed | XV_CFI_SWATHPOS_COMPUTE_ORB_NUM_OEF_ERR        | 9        |

|      |  |                           |   |    |
|------|--|---------------------------|---|----|
| ERR  | Input time greater than orbital period.                                    | Computation not performed | XV_CFI_SWATHPOS_COM<br>PUTE_TIME_ERR                  | 10 |
| ERR  | Repeat Days Cycle of this orbit is not the same than the swath template.   | Computation not performed | XV_CFI_SWATHPOS_COM<br>PUTE_REP_CYCLE_ERR             | 11 |
| ERR  | Orbits Cycle Length of this orbit is not the same than the swath template. | Computation not performed | XV_CFI_SWATHPOS_COM<br>PUTE_CYCLE_LENGTH_E<br>RR      | 12 |
| ERR  | MLST drift of this orbit is not the same than the swath template.          | Computation not performed | XV_CFI_SWATHPOS_COM<br>PUTE_MLST_DRIFT_ERR            | 13 |
| ERR  | No spherical triangle.   | Computation not performed | XV_CFI_SWATHPOS_COM<br>PUTE_SPHER_TRIANG_E<br>RR      | 14 |
| ERR  | Error while transforming from relative to absolute orbit.                  | Computation not performed | XV_CFI_SWATHPOS_COM<br>PUTE_REL_TO_ABS_ERR            | 15 |
| ERR  | Error while computing information of the orbit.                            | Computation not performed | XV_CFI_SWATHPOS_COM<br>PUTE_XV_ORBIT_INFO_E<br>RR     | 16 |
| ERR  | The swath template structure contains invalid data                         | Computation not performed | XV_CFI_SWATHPOS_COM<br>PUTE_SWATH_INIT_ERR            | 17 |
| ERR  | Error allocating internal memory.  | Computation not performed | XV_CFI_SWATHPOS_COM<br>PUTE_MEMORY_ERR                | 18 |
| ERR  | Geostationary satellite not allowed for this function.                     | Computation not performed | XV_CFI_SWATHPOS_COM<br>PUTE_GEO_SAT_ERR               | 19 |
| ERR  | Wrong input time type. Orbit data must be provided.                        | Computation not performed | XV_CFI_SWATHPOS_COM<br>PUTE_TIME_TYPE_ERR             | 20 |
| ERR  | Error generating Swath Template File                                       | Computation not performed | XV_CFI_SWATHPOS_COM<br>PUTE_GEN_SWATH_ERR             | 21 |
| ERR  | Error reading Swath File: %s   | Computation not performed | XV_CFI_SWATHPOS_COM<br>PUTE_READ_SWATH_FILE<br>_ERR   | 22 |
| WARN | Orbit outside STF validity but no recomputation can be performed.          | Computation performed     | XV_CFI_SWATHPOS_COM<br>PUTE_SWATH_VALIDITY_<br>WARN   | 23 |
| ERR  | Error transforming time to orbit.  | Computation not performed | XV_CFI_SWATHPOS_COM<br>PUTE_TIME_TO_ORBIT_E<br>RR     | 24 |
| ERR  | Input file is not a swath file.  | Computation not performed | XV_CFI_SWATHPOS_COM<br>PUTE_DETECT_SWATH_T<br>YPE_ERR | 25 |

## 7.10xv\_star\_vis\_time

### 7.10.1 Overview

The **xv\_star\_vis\_time** function computes stars visibility segments, the orbital segments for which a given star is visible with a given instrument from the satellite.

An orbital segment is a time interval along the orbit, defined by start and stop times expressed as seconds elapsed since the ascending node crossing.

In addition, **xv\_star\_vis\_time** calculates for every start and end of the visibility segment a coverage flag, determining which side of the FOV the event took place.

**xv\_star\_vis\_time** requires access to several data structures and files to produce its results:

- the **orbit\_id** (**xo\_orbit\_id**) providing the orbital data. The **orbit\_id** can be initialized with the following data or files, also with precise propagation if applicable (see [ORBIT\_SUM]):
  - data for an orbital change
  - Orbit scenario files
  - Predicted orbit files
  - Orbit Event Files (**Note: Orbit Event File is deprecated, only supported for CRYOSAT mission**)
  - Restituted orbit files
  - DORIS Preliminary orbit files
  - DORIS Navigator files
  - TLE files

Note: if the orbit is initialized for precise propagation, the execution of the visibility function can be very slow. As alternative, a POF can be generated with the precise propagator (function **xo\_gen\_pof**) for the range of orbits the user usually needs, and use this generated file to initialize the orbit id. The execution time performance will be much better for the visibility function and it will not have a big impact on the precision of the calculations.

- Two Inertial Reference Swath Files. The Swath data can be provided by:
  - A swath template file produced off-line by the EO\_VISIBILITY library (**xv\_gen\_swath** function).
  - A swath definition file, describing the swath geometry. In this case the **xv\_star\_vis\_time** generates the swath points for a number of orbits given by the user.
- (*Optional*) The Star's Database File, describing the location in right ascension and declination of a star, described by its corresponding identifier.

The time intervals used by **xv\_star\_vis\_time** are expressed in absolute or relative orbit numbers. This is valid for both:

- input parameter "Orbit Range": first and last orbit to be considered. In case of using relative orbits, the corresponding cycle number should be used, otherwise, this the cycle number will be a dummy parameter
- output parameter "Star Visibility Segments": time segments with time expressed as {absolute orbit number (or relative orbit and cycle number), number of seconds since ANX, number of microsecs}

The orbit representation (absolute or relative) for the output segments will be the same as in the input orbits. Moreover, the segments will be ordered chronologically.

Users who need to use processing times must make use of the conversion routines provided in EO\_VISIBILITY (**xv\_time\_to\_orbit** and **xv\_orbit\_to\_time** functions).

## 7.10.2 Swath Definition

`xv_star_vis_time` calculates stars visibility segments for FOV corresponding to limb-sounding instruments observing inertial objects. The corresponding template files are generated off-line by the EO\_VISIBILITY CFI software (`xv_gen_swath` function).

### 7.10.2.1 Inertial Swaths

The FOV for a Limb-sounding instrument observing inertial objects is calculated using two main parameters.

- The FOV projection on the celestial sphere is determined by two set of swaths, one corresponding to a higher (TOP) and a lower (BOTTOM) altitude over the ellipsoid, hence defining the elevation range of the FOV
- The azimuth range is defined as such, the extremes corresponding to the left and right sides. In addition `xv_gen_swath` generates coordinates for a middle point

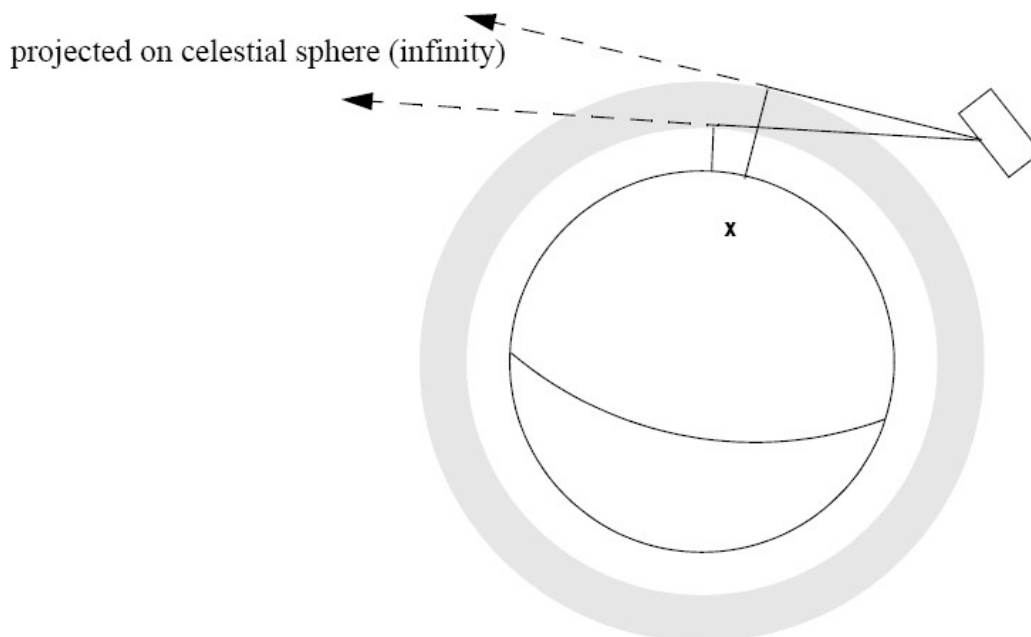

**Figure 19: Two tangent altitudes over the ellipsoid**

The instantaneous FOV projected on the celestial sphere can be represented as a series of points defined by their Right Ascension and Declination coordinates.

The top and bottom lines sweep the azimuth range at a constant tangent altitude, whilst the left and right side have a constant azimuth value with changing tangent altitude.

The shape of FOV should be similar to that shown in the diagram below with the dotted lines, whilst the algorithm implemented in `xv_star_vis_time` uses a simplified model joining the points with straight line.

As the satellite evolves around the orbit and the FOV sweeps the celestial sphere, a star can enter the FOV. `xv_star_vis_time` calculates that time and returns a flag indicating which part of the FOV (*LEFT*, *TOP*, *RIGHT* or *BOTTOM*) first detected the star. The same is done when the star exits the FOV.

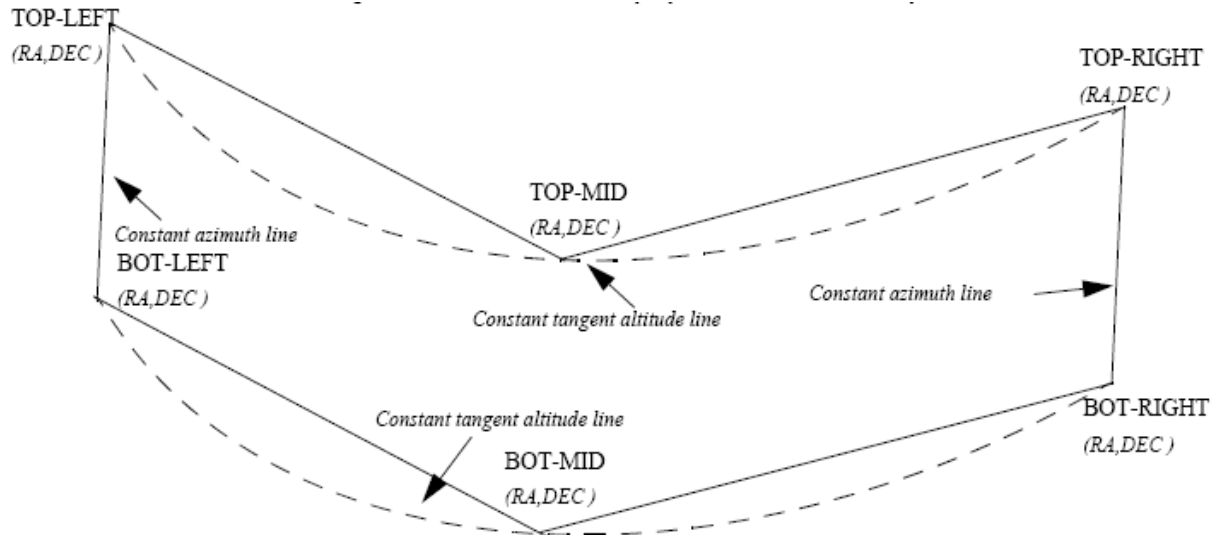

**Figure 20: Instantaneous FOV projected on the celestial sphere**

### 7.10.2.2 Splitting swaths

As it was shown in Figure 20, the accuracy and precision of `xv_star_vis_time` strongly depends on how close the projection used in the algorithm is to the real world. Higher accuracy can be obtained splitting the azimuth range in sub-swaths.

Furthermore, splitting the swath would be necessary if the FOV was to cover an azimuth range larger than 180 degrees.

Note: It is important to note that if the FOV covers the value of 90 or 270 degrees in azimuth, one of the extremes (*LEFT* or *RIGHT*) of the STF must correspond to that azimuth value.

### 7.10.2.3 Orbital Changes

If `xv_star_vis_time` is used with a range of orbits that includes an orbital change (e.g. change in the repeat cycle or cycle length), the behaviour depends on the swath files introduced as input:

- If **swath template files** are used, `xv_star_vis_time` automatically will ignore the orbits that do not correspond with the template files (i.e. no visibility segments will be generated for those orbits), since swath template files are generated from a reference orbit with a particular geometry, so they are not valid for a different geometry.

- If **swath definition files** are introduced, `xv_station_vis_time` will perform the computations across orbital changes, and will return the visibility segments corresponding to the whole orbital range. Internally, swath templates valid for every orbital change are generated to perform the calculations.



#### **7.10.2.4 Format of Swath Template File**

If a swath template file with the variable header tags *Start\_VValidity\_Range* and *Stop\_VValidity\_Range* is used as input, only the segments belonging to that orbit range will be returned.

#### **7.10.2.5 MLST non linear drift**

If a swath definition file is introduced, it can be also introduced every how many orbits the swath template file must be recomputed (*swath\_flag* parameter, see section 164). If the *orbit\_id* has been initialized with an OSF file with MLST non linear terms and the parameter *swath\_flag* is greater than the linear approximation validity, the recomputation of swath template file will be done every linear approximation validity orbits.

### 7.10.3 Calling sequence *xv\_star\_vis\_time*

For C programs, the call to *xv\_star\_vis\_time* is (input parameters are underlined):

```
#include "explorer_visibility.h"
{
    xo_orbit_id  orbit_id = {NULL};
    long        swath_flag, orbit_type,
               start_orbit, start_cycle,
               stop_orbit, stop_cycle,
               number_segments,
               *bgn_orbit, *bgn_second, *bgn_microsec,
               *bgn_cycle, *bgn_coverage,
               *end_orbit, *end_second, *end_microsec,
               *end_cycle, *end_coverage,
               ierr[XV_NUM_ERR_STAR_VIS_TIME], status;
    double      star_ra, star_dec, star_ra_deg, star_dec_deg,
               min_duration;
    char        *orbit_scenario_file,
               *swath_file_upper, *swath_file_lower;
    char        star_id[8], *star_db_file;

    status = xv_star_vis_time(
        &orbit_id, &orbit_type,
        &start_orbit, &start_cycle,
        &stop_orbit, &stop_cycle,
        &swath_flag, &swath_file_upper, &swath_file_lower,
        &star_id, &star_db_file,
        &star_ra, &star_dec,
        &min_duration,
        &star_ra_deg, &star_dec_deg,
        &number_segments,
        &bgn_orbit, &bgn_second, &bgn_microsec,
        &bgn_cycle, &bgn_coverage,
        &end_orbit, &end_second, &end_microsec,
        &end_cycle, &end_coverage,
        ierr);
}
```

```
/* Or, using the run_id */
long run_id;

status = xv_star_vis_time_run(
    &run_id, &orbit_type,
    &start_orbit, &start_cycle,
    &stop_orbit, &stop_cycle,
    &swath_flag, swath_file_upper, swath_file_lower,
    star_id, star_db_file,
    &star_ra, &star_dec,
    &min_duration,
    &star_ra_deg, &star_dec_deg,
    &number_segments,
    &bgn_orbit, &bgn_second, &bgn_microsec,
    &bgn_cycle, &bgn_coverage,
    &end_orbit, &end_second, &end_microsec,
    &end_cycle, &end_coverage,
    ierr);
}
```

## 7.10.4 Input parameters *xv\_star\_vis\_time*

Table 34: Input parameters of *xv\_star\_vis\_time*

| C name      | C type       | Array Element | Description  | Unit (Format)                     | Allowed Range   |
|-------------|--------------|---------------|--|-----------------------------------|---|
| orbit_id    | xo_orbit_id* | -             | Structure that contains the orbit data   | -                                 | -   |
| orbit_type  | long         | -             | Define the type of orbit representation, i.e. absolute or relative orbits in the input/output parameters   | -                                 | Complete  |
| start_orbit | long         | -             | First orbit, segment filter.<br>Segments will be filtered as from the beginning of first orbit (within orbit range from orbit_scenario_file)<br>If set to zero then first orbit of orbit_scenario_file is selected.  | absolute or relative orbit number | = 0<br>or:<br>absolute orbits $\geq$ start_osf<br>relative orbits $\leq$ repeat cycle |
| start_cycle | long         | -             | Cycle number corresponding to the start_orbit. Dummy when using relative orbits  | cycle number                      | = 0 or<br>$\geq$ start_osf  |
| stop_orbit  | long         | -             | Last orbit, segment filter.<br>When:<br><ul style="list-style-type: none"> <li>stop_orbit = 0 (for orbit_type = XV_ORBIT_ABS)</li> <li>stop_orbit = 0 and stop_cycle = 0 (for orbit_type = XV_ORBIT_REL)</li> </ul> the stop_orbit will be set to the minimum value between:<br><ul style="list-style-type: none"> <li>the last orbit within the orbital change of the start_orbit.</li> <li>start_orbit+cycle_length-1 (i.e. the input orbit range will be a complete cycle)</li> </ul> If it is not initialized with orbital changes, stop orbit will be set to the last orbit in orbit_id initialization. | absolute or relative orbit number | = 0<br>or:<br>absolute orbits $\geq$ start_osf<br>relative orbits $\leq$ repeat cycle |
| stop_cycle  | long         | -             | Cycle number corresponding to the stop_orbit. Dummy when using relative orbits   | cycle number                      | =0 or<br>$\geq$ start_osf   |
| swath_flag  | long*        | -             | Define the use of the swath file:<br><ul style="list-style-type: none"> <li>0 = (XV_STF) if the swath file is a</li> </ul>   | -                                 | XV_STF = 0<br>XV_SDF = 1  |

|                  |         |  |   |     |                      |
|------------------|---------|--|---|-----|----------------------|
|                  |         |  | <p>swath template file.</p> <ul style="list-style-type: none"> <li>&gt; 0 if the swath files is a swath definition file. In this case the swath points are generated for every "swath_flag" orbits</li> </ul> |     | > 0                  |
| swath_file_upper | char *  |  | <p>File name of the inertial swath-file for the appropriate instrument mode, which defines the upper limit of the FOV.</p> <p>This file is read each time the function is called</p>                          |     |                      |
| swath_file_lower | char *  |  | <p>File name of the inertial swath-file for the appropriate instrument mode, which defines the lower limit of the FOV.</p> <p>This file is read each time the function is called</p>                          |     |                      |
| star_id[8]       | char    |  | <p>identification of the star, as defined in the star_db_file. This parameter is used <b>ONLY IF</b> star_db_file is not equal empty string(“”)</p>   |     | EXACTLY 8 characters |
| star_db_file     | char *  |  | File name of the star database file   |     |                      |
| star_ra          | double* |  | <p>Right Ascension of Star, in TOD.</p> <p>This parameter is used <b>ONLY IF</b> star_db_file is equal empty string(“”)</p>   | deg | (-180.0, 180.0)      |
| star_dec         | double* |  | <p>Declination of Star, in TOD.</p> <p>This parameter is used <b>ONLY IF</b> star_db_file is equal empty string(“”)</p>   | deg | (-90.0, 90.0)        |
| min_duration     | double* |  | <p>Minimum duration for segments.</p> <p>Only segments with a duration longer than min_duration will be given on output.</p>  | s   | ≥ 0.0                |

## 7.10.5 Output parameters *xv\_star\_vis\_time*

Table 35: Output Parameters of *xv\_star\_vis\_time*

| C name                  | C type | Array Element | Description  | Unit (Format) | Allowed Range                          |
|-------------------------|--------|---------------|--|---------------|--|
| <i>xv_star_vis_time</i> | long   |               | Function status flag,<br>= 0 No error<br>> 0 Warnings, results generated<br>< 0 Error, no results generated  |               |  |
| <i>star_ra_deg</i>      | double |               | Right Ascension of the star, in TOD, for the UTC halfway <i>start_orbit</i> and <i>stop_orbit</i> .  | deg           | (-180.0, 180.0)                        |
| <i>star_dec_deg</i>     | double |               | Declination of the star, in TOD, for the UTC halfway <i>start_orbit</i> and <i>stop_orbit</i> .  | deg           | (-90.0, 90.0)                          |
| <i>number_segment</i>   | long   |               | Number of visibility segments returned to the user   |               | ≥ 0                                    |
| <i>bgn_orbit</i>        | long*  | all           | Orbit number,<br>begin of visibility segment <i>i</i><br><i>bgn_orbit</i> [ <i>i</i> -1],<br><i>i</i> = 1, <i>number_segments</i>                  |               | > 0                                    |
| <i>bgn_second</i>       | long*  | all           | Seconds since ascending node,<br>begin of visibility segment <i>i</i><br><i>bgn_second</i> [ <i>i</i> -1],<br><i>i</i> = 1, <i>number_segments</i> | s             | ≥ 0<br>< orbital period                |
| <i>bgn_microsec</i>     | long*  | all           | Micro seconds within second<br>begin of visibility segment <i>i</i><br><i>bgn_microsec</i> [ <i>i</i> -1],<br><i>i</i> = 1, <i>number_segments</i> | μs            | ≥ 0<br>≤ 999999                        |
| <i>bgn_cycle</i>        | long*  | all           | cycle number<br>begin of visibility segment <i>i</i><br><i>bgn_microsec</i> [ <i>i</i> -1],<br><i>i</i> = 1, <i>number_segments</i>                |               | > 0<br>NULL when using relative orbits |
| <i>bgn_coverage</i>     | long*  | all           | Coverage flag for swath entry:<br>XV_STAR_UNDEFINED = 0,<br>XV_STAR_UPPER = 1,<br>XV_STAR_LOWER = 2,<br>XV_START_LEFT = 3,                         |               | 0,1,2,3,4                              |

|              |       |     |  |    |   |
|--------------|-------|-----|--|----|---|
|              |       |     | XV_STAR_RIGHT=4  |    |   |
| end_orbit    | long* | all | Orbit number,<br>end of visibility segment i<br>end_orbit[i-1],<br>i = 1, number_segments  |    | > 0   |
| end_second   | long* | all | Seconds since ascending node,<br>end of visibility segment i<br>end_second[i-1],<br>i = 1, number_segments                                   | s  | ≥ 0<br><orbital<br>period                   |
| end_microsec | long* | all | Micro seconds within second<br>end of visibility segment i<br>end_microsec[i-1],<br>i = 1, number_segments                                   | μs | 0<br>≤ 999999                               |
| end_cycle    | long* | all | End cycle,<br>end of visibility segment i<br>end_orbit[i-1],<br>i = 1, number_segments   |    | >0<br>NULL when<br>using relative<br>orbits |
| end_coverage | long* | all | Coverage flag for swath exit:<br>XV_STAR_UNDEFINED = 0,<br>XV_STAR_UPPER = 1,<br>XV_STAR_LOWER = 2,<br>XV_START_LEFT = 3,<br>XV_STAR_RIGHT=4 |    | 0,1,2,3,4                                   |
| ierr[10]     | long  |     | Error status flags   |    |   |

**Memory Management:** Note that the output visibility segments arrays are pointers to integers instead of static arrays. The memory for these dynamic arrays is allocated within the `xv_star_vis_time` function. So the user will only have to declare those pointers but not to allocate memory for them. However, once the function has returned without error, the user will have the responsibility of freeing the memory for those pointers once they are not used.

## 7.10.6 Warnings and errors

Next table lists the possible error messages that can be returned by the `xv_star_vis_time` CFI function after translating the returned status vector into the equivalent list of error messages by calling the function of the `EO_VISIBILITY` software library `xv_get_msg`.

This table also indicates the type of message returned, i.e. either a warning (WARN) or an error (ERR), the cause of such a message and the impact on the performed calculation, mainly on the results vector.

The table is completed by the error code and value. These error codes can be obtained translating the status vector returned by the `xv_star_vis_time` CFI function by calling the function of the `EO_VISIBILITY` software library `xv_get_code`.

**Table 36: Error messages and codes**

| Error type | Error message   | Cause and impact                                    | Error Code                                  | Error No |
|------------|---|---|---|----------|
| ERR        | Error, wrong orbit Id.  | Computation not performed                           | XV_CFI_STAR_VIS_TIME_ORBIT_STATUS_ERR       | 0        |
| WAR N      | Warning, start orbit is outside range of OEF/OSF.                                   | Computation performed<br>Message to inform the user | XV_CFI_STAR_VIS_TIME_FIRST_ORBIT_WARN       | 1        |
| WAR N      | Warning, stop orbit is outside range of OEF/OSF.                                    | Computation performed<br>Message to inform the user | XV_CFI_STAR_VIS_TIME_LAST_ORBIT_WARN        | 2        |
| WAR N      | Warning, there is an orbital change within the requested orbits.                    | Computation performed<br>Message to inform the user | XV_CFI_STAR_VIS_TIME_ORBIT_CHANGE_WARN      | 3        |
| ERR        | Error, starvistime can only operate with an inertial swath.                         | Computation not performed                           | XV_CFI_STAR_VIS_TIME_INERTIAL_SWATH_ERR     | 4        |
| ERR        | Error, Orbital information does not coincide with reference swath.                  | Computation not performed                           | XV_CFI_STAR_VIS_TIME_INCONSISTENT_SWATH_ERR | 5        |
| ERR        | Input parameter "\swath_flag" is out of range                                       | Computation not performed                           | XV_CFI_STAR_VIS_TIME_SWATH_FLAG_ERR         | 6        |
| ERR        | Could not generate the swath template data  | Computation not performed                           | XV_CFI_STAR_VIS_TIME_GENSWATH_ERR           | 7        |
| ERR        | Low swath altitude is above the upper limit described by the higher swath altitude. | Computation not performed                           | XV_CFI_STAR_VIS_TIME_ALT_ERR                | 8        |
| ERR        | Error allocating internal memory.   | Computation not performed                           | XV_CFI_STAR_VIS_TIME_INTERNAL_MEMORY_ERR    | 9        |
| ERR        | Error allocating memory for the   | Computation not                                     | XV_CFI_STAR_VIS_TIME                        | 10       |



|     |  |                           |   |    |
|-----|--|---------------------------|---|----|
|     | visibility segments.   | performed                 | E_SEGMENTS_MEMORY_ERR                     |    |
| ERR | Error allocating memory for the coverage.                          | Computation not performed | XV_CFI_STAR_VIS_TIME_COVERAGE_MEMORY_ERR  | 11 |
| ERR | Input parameter "orbit_type" is out of range.                      | Computation not performed | XV_CFI_STAR_VIS_TIME_ORBIT_TYPE_ERR       | 12 |
| ERR | Wrong input Orbit Id. Unknown orbit initialization mode            | Computation not performed | XV_CFI_STAR_VIS_TIME_ORBIT_MODEL_ERR      | 13 |
| ERR | Error in input parameter to starvstime.                            | Computation not performed | XV_CFI_STAR_VIS_TIME_INPUTS_CHECK_ERR     | 14 |
| ERR | Error while transforming into absolute orbit the start_orbit.      | Computation not performed | XV_CFI_STAR_VIS_TIME_REL_TO_ABS_START_ERR | 15 |
| ERR | Error while transforming into absolute orbit the stop_orbit.       | Computation not performed | XV_CFI_STAR_VIS_TIME_REL_TO_ABS_STOP_ERR  | 16 |
| ERR | Error updating star's position in from JD2000 to determined UTC.   | Computation not performed | XV_CFI_STAR_VIS_TIME_STAR_RADEC_ERR       | 17 |
| ERR | Error obtaining orbital information.                               | Computation not performed | XV_CFI_STAR_VIS_TIME_ORBIT_INFO_ERR       | 18 |
| ERR | Error reading the upper swath template file.                       | Computation not performed | XV_CFI_STAR_VIS_TIME_SWATH_UPPER_READ_ERR | 19 |
| ERR | Error reading the lower swath template file.                       | Computation not performed | XV_CFI_STAR_VIS_TIME_SWATH_LOWER_READ_ERR | 20 |
| ERR | Error reading the star data file.                                  | Computation not performed | XV_CFI_STAR_VIS_TIME_READ_STAR_ERR        | 21 |
| ERR | Error determining transitions.                                     | Computation not performed | XV_CFI_STAR_VIS_TIME_STAR_MAIN_ERR        | 22 |
| ERR | Error while transforming into relative orbits the output segments. | Computation not performed | XV_CFI_STAR_VIS_TIME_ABS_TO_REL_ERR       | 23 |
| ERR | Error transforming orbit to time.                                  | Computation not performed | XV_CFI_STAR_VIS_TIME_ORBIT_TO_TIME_ERR    | 24 |
| ERR | Error reading the swath definition file: %s                        | Computation not performed | XV_CFI_STAR_VIS_TIME_READ_SDF_ERR         | 25 |
| ERR | Error checking orbital change                                      | Computation not           | XV_CFI_STAR_VIS_CHECK_                    | 26 |

|      | in range   | performed                 | ORBITAL_CHANGE_ERR  |    |
|------|--|---------------------------|---|----|
| ERR  | Input orbit interval is completely outside STF validity interval                                   | Computation not performed | XV_CFI_STAR_VIS_TIME_ORBIT_INTERVAL_STF_ERR                     | 27 |
| WARN | Input orbit interval is partially outside STF validity interval                                    | Computation performed     | XV_CFI_STAR_VIS_TIME_ORBIT_INTERVAL_STF_WARN                    | 32 |
| WARN | Input OSF has non-trivial MLST non linear terms but STF was generated without them                 | Computation performed     | XV_CFI_STAR_VIS_TIME_OSF_NON_LIN_STF_OLD_WARN                   | 33 |
| WARN | Swath flag larger than MLST linear approximation validity. MLST linear approximation validity used | Computation performed     | XV_CFI_STAR_VIS_TIME_SWATH_FLAG_LARGER_THAN_LIN_APPROX_VAL_WARN | 34 |
| WARN | Visibility computations with precise propagator can be very slow                                   | Computation performed     | XV_CFI_STAR_VIS_TIME_PRECISE_PROPAG_WARN                        | 35 |

## 7.11 **xv\_multizones\_vis\_time**

### 7.11.1 **Overview**

**Note:** this function is deprecated. Use **xv\_zonevistime\_compute** instead.

The **xv\_multizones\_vis\_time** function computes all the orbital segments for which a given instrument swath intercepts several user-defined zones at the surface of the Earth ellipsoid.

The visibility segments are obtained by calling to **xv\_zone\_vis\_time** (see section 7.1 for further details about swaths, zones and visibility segments definitions). Those segments are merged and ordered by start time. In addition to this, two tables are provided. The first one contains the zones where segment has visibility, and the second one contains the coverage of the segment for each zone (see Figure 21).

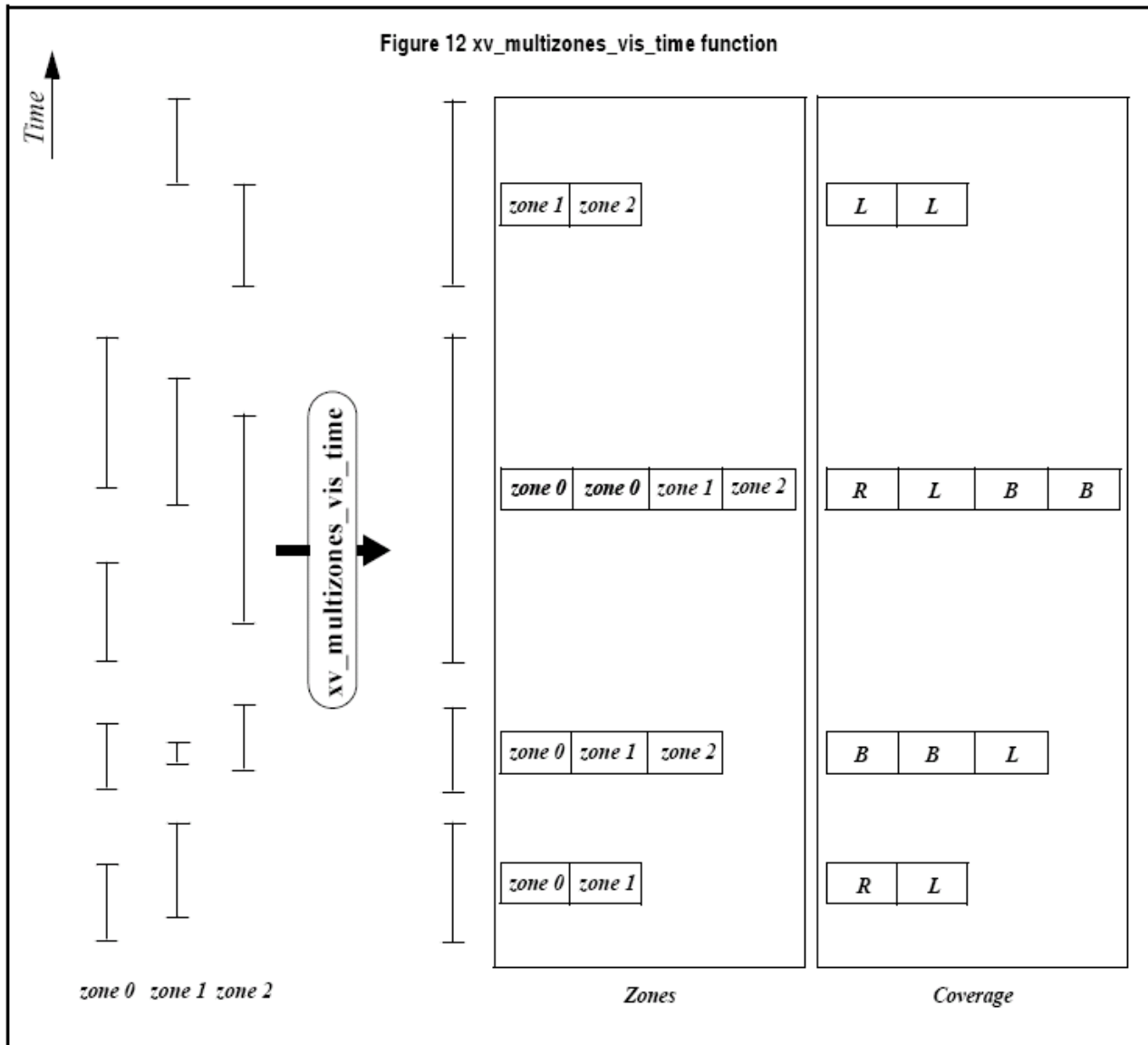

**Figure 21: xv\_multizones\_vis\_time function**

The time intervals used by **xv\_multizones\_vis\_time** are expressed in absolute orbit numbers or in relative orbit and cycle numbers. This is valid for both:

- input parameter “Orbit Range”: first and last orbit to be considered. In case of using relative orbits, the corresponding cycle number should be used, otherwise, this the cycle number will be a dummy parameter.
- output parameter “Zone Visibility Segments”: time segments with time expressed as {absolute orbit number (or relative orbit number and cycle number), number of seconds since ascending node, number of microseconds}

The orbit representation (absolute or relative) for the output segments will be the same as in the input orbits.

**xv\_multizones\_vis\_time** requires access to several data structures and files to produce its results:

- the orbit\_id (xo\_orbit\_id) providing the orbital data. The orbit\_id can be initialized with the following data or files (see [ORBIT\_SUM]):
  - data for an orbital change
  - Orbit scenario files
  - Predicted orbit files
  - Orbit Event Files (**Note: Orbit Event File is deprecated, only supported for CRYOSAT mission**)
  - Restituted orbit files
  - DORIS Preliminary orbit files
  - DORIS Navigator files

Note: if the orbit is initialized for precise propagation, the execution of the visibility function can be very slow. As alternative, a POF can be generated with the precise propagator (function xo\_gen\_pof) for the range of orbits the user usually needs, and use this generated file to initialize the orbit id. The execution time performance will be much better for the visibility function and it will not have a big impact on the precision of the calculations.

- the Instrument Swath File, excluding inertial swath files, describing the area seen by the relevant instrument all along the current orbit. The Swath data can be provided by:
  - A swath template file produced off-line by the EO\_VISIBILITY library (**xv\_gen\_swath** function).
  - A swath definition file, describing the swath geometry. In this case the **xv\_multizones\_vis\_time** generates the swath points for a number of orbits given by the user.
- optionally, a Zone Database File, containing the zone description. The user can either specify a zone identifier referring to a zone in the file, or provide the zone parameters directly to **xv\_multizones\_vis\_time**.

Users who need to use processing times must make use of the conversion routines provided in EO\_ORBIT (**xo\_time\_to\_orbit** and **xo\_orbit\_to\_time** functions).

**NOTE:** If **xv\_multizones\_vis\_time** is used with a range of orbits that includes an orbital change (e.g. change in the repeat cycle or cycle length), the behaviour depends on the swath files introduced as input:

•If a **swath template file** is used, **xv\_multizones\_vis\_time** automatically will ignore the orbits that do not correspond with the template file (i.e. no visibility segments will be generated for those orbits), since swath template file is generated from a reference orbit with a particular geometry, so it is not valid for a different geometry.

•If a **swath definition file** is introduced, **xv\_multizones\_vis\_time** will perform the computations across orbital changes, and will return the visibility segments corresponding to the whole orbital range. Internally, swath templates valid for every orbital change are generated to perform the calculations.

## 7.11.2 Calling sequence *xv\_multizones\_vis\_time*

For C programs, the call to `xv_multizones_vis_time` is (input parameters are underlined):

```
#include "explorer_visibility.h"
{

    xo_orbit_id orbit_id = {NULL};
    long        swath_flag, orbit_type,
               start_orbit, start_cycle, stop_orbit, stop_cycle,
               num_zones, projection, *zone_num,
               extra_info_flag,
               number_segments,
               *bgn_orbit, *bgn_secs, *bgn_microsecs, *bgn_cycle,
               *end_orbit, *end_secs, *end_microsecs, *end_cycle,
               *nb_zon_in_segment, **zones_in_segment, **coverage,
               ierr[XV_NUM_ERR_MULTIZONES_VIS_TIME], status;

    double     *zone_long, *zone_lat, *zone_diam,
               min_duration;

    char       *swath_file, *zone_db_file,
               **zone_id;

    status = xv_multizones_vis_time(
        &orbit_id, &orbit_type,
        &start_orbit, &start_cycle,
        &stop_orbit, &stop_cycle,
        &swath_flag, swath_file, &num_zones,
        zone_id, zone_db_file,
        projection, zone_num,
        zone_long, zone_lat, zone_diam,
        &min_duration, &extra_info_flag,
        &number_segments,
        &bgn_orbit, &bgn_second, &bgn_microsec, &bgn_cycle,
        &end_orbit, &end_second, &end_microsec, &end_cycle,
        &nb_zon_in_segment, &zones_in_segment, &coverage,
        ierr);
}
```

```
/* Or, using the run_id */
long run_id;

status = xv_multizones_vis_time_run(
    &run_id, &orbit_type,
    &start_orbit, &start_cycle,
    &stop_orbit, &stop_cycle,
    &swath_flag, swath_file, &num_zones,
    zone_id, zone_db_file,
    projection, zone_num,
    zone_long, zone_lat, zone_diam,
    &min_duration, &extra_info_flag,
    &number_segments,
    &bgn_orbit, &bgn_second, &bgn_microsec, &bgn_cycle,
    &end_orbit, &end_second, &end_microsec, &end_cycle,
    &nb_zon_in_segment, &zones_in_segment, &coverage,
    ierr);
}
```

### 7.11.3 Input parameters *xv\_multizones\_vis\_time*

Table 37: Input parameters of *xv\_multizones\_vis\_time*

| C name        | C type       | Array Element | Description  | Unit (Format)                     | Allowed Range   |
|---------------|--------------|---------------|--|-----------------------------------|---|
| orbit_id      | xo_orbit_id* | -             | Structure that contains the orbit data   | -                                 | -   |
| orbit_type    | long         | -             | Define the type of orbit representation, i.e. absolute or relative orbits in the input/output parameters   | -                                 | Complete (see Table 3 )   |
| start_orbit   | long         | -             | First orbit, segment filter.<br>Segments will be filtered as from the beginning of first orbit (within orbit range from orbit_scenario_file)<br>First Orbit in the orbit_scenario_file will be used when: <ul style="list-style-type: none"> <li>Absolute orbit is set to zero.</li> <li>Relative orbit and cycle number set to zero.</li> </ul>   | absolute or relative orbit number | = 0<br>or:<br><ul style="list-style-type: none"> <li>absolute orbits <math>\geq</math> start_osf</li> <li>relative orbits <math>\leq</math> repeat cycle</li> </ul> |
| • start_cycle | long         | -             | Cycle number corresponding to the start_orbit. Dummy when using relative orbits  | cycle number                      | = 0 or<br>$\geq$ first cycle in osf   |
| stop_orbit    | long         | -             | Last orbit, segment filter.<br>When: <ul style="list-style-type: none"> <li>stop_orbit = 0 (for orbit_type = XV_ORBIT_ABS)</li> <li>stop_orbit = 0 and stop_cycle = 0 (for orbit_type = XV_ORBIT_REL)</li> </ul> the stop_orbit will be set to the minimum value between: <ul style="list-style-type: none"> <li>the last orbit within the orbital change of the start_orbit.</li> <li>start_orbit+cycle_length-1 (i.e. the input orbit range will be a complete cycle)</li> </ul> | absolute or relative orbit number | = 0<br>or:<br><ul style="list-style-type: none"> <li>absolute orbits <math>\geq</math> start_osf</li> <li>relative orbits <math>\leq</math> repeat cycle</li> </ul> |
| stop_cycle    | long         | -             | Cycle number corresponding to the stop_orbit. Dummy when using relative orbits   | cycle number                      | = 0 or<br>$\geq$ first cycle in osf   |
| swath_flag    | long*        | -             | Define the use of the swath file: <ul style="list-style-type: none"> <li>0 = (XV_STF) if the swath file is a swath template file.</li> <li>&gt; 0 if the swath files is a swath</li> </ul>   | -                                 | XV_STF = 0<br>XV_SDF = 1<br>> 0   |



|              |         |     |  |     |  |
|--------------|---------|-----|--|-----|--|
|              |         |     | definition file. In this case the swath points are generated for every "swath_flag" orbits   |     |  |
| swath_file   | char *  | -   | File name of the swath-file for the appropriate instrument mode  |     |  |
| num_zones    | long    | -   | Number of zones  |     | >0                                     |
| zone_id      | char**  | all | Identification name for n-th zone (0<n<num_zones). It must exist for every zone.<br><br>zone_id[i] must belong to a zone from the zone_db_file when zone_num[i]=0.   |     |  |
| zone_db_file | char *  | -   | File name of the zone-database file. Dummy when no zones from database are selected.   |     |  |
| projection   | long*   | all | projection for each zone used to define polygon sides as straight lines.   |     | complete.<br>See Table 3 (Projections) |
| zone_num     | long*   | all | Number of vertices of the n-th zone (0<n<num_zones) provided in zone_long, zone_lat:<br><br>= 0 no vertices provided, use zone_id / zone_db_file<br>= 1 Point / Circular zone,<br>= 2 Line zone<br>> 2 Polygon zone  |     | ≥ 0                                    |
| zone_long    | double* | all | Geocentric longitude of<br><br>- circle centre, for circ. zone<br>- point, for point zone<br>- line-end, for line zone<br>- vertices, for polygon zone.<br><br>The longitude of the vertices corresponding to all zones shall be arranged consecutively <sup>3</sup> . | deg |  |
| zone_lat     | double* | all | Geodetic latitude of<br><br>- circle centre, for circ. zone.   | deg |  |

<sup>3</sup> For example,

- zone 0: points will be arranged from 0 to zone\_num[0] (no points in case of using a database zone),
- zone 1: points will be arranged from zone\_num[0] to zone\_num[0] + zone\_num[1]
- ...

|                 |         |     |   |   |                     |
|-----------------|---------|-----|---|---|---------------------|
|                 |         |     | <ul style="list-style-type: none"> <li>- point, for point zone.</li> <li>- line-end, for line zone.</li> <li>- vertices, for polygon zone.</li> </ul> <p>The latitude of the vertices corresponding to all zones shall be arranged consecutively.</p> |   |                     |
| zone_diam       | double* | all | <p>Array of diameters of circular zones in case this shape is selected for any zone<sup>4</sup>.</p> <p>zone_diam=0.0 for Point Zones.</p>  | m | ≥ 0.0               |
| min_duration    | double  | -   | <p>Minimum duration for segments.</p> <p>Only segments with a duration longer than min_duration will be given on output.</p>  | s | ≥ 0                 |
| extra_info_flag | long    | -   | <p>If value set to false (= 0), the zones_in_segment and coverage arrays are not computed.</p> <p>Saves computation time.</p>   |   | 0 (false), 1 (true) |

---

4 The values corresponding to all zones shall be arranged consecutively, so that the zone\_diam[0] corresponds with the first point or circular zone, zone\_diam[1] corresponds with the second point or circular zone, and so on.

## 7.11.4 Output parameters *xv\_multizones\_vis\_time*

Table 38: Output parameters of *xv\_multizones\_vis\_time*

| C name                        | C type | Array Element | Description   | Unit (Format) | Allowed Range           |
|-------------------------------|--------|---------------|---|---------------|-------------------------|
| <i>xv_multizones_vis_time</i> | long   |               | Function status flag,<br>= 0 No error<br>> 0 Warnings, results generated<br>< 0 Error, no results generated |               |                         |
| number_segments               | long   | -             | Number of segments in the output lists.   | -             | > 0                     |
| bgn_orbit                     | long*  | all           | Array of orbit numbers for the beginning of the segments  | -             | >0                      |
| bgn_second                    | long*  | all           | Array of seconds elapsed since ANX for the beginning of the segments  | -             | >0<br><nodal period     |
| bgn_microsec                  | long*  | all           | Array of microseconds within a second for the beginning of the segments                                     | -             | >0<br><999999           |
| bgn_cycle                     | long*  | all           | Array of cycle numbers for the beginning of the segments.   | -             | >0                      |
| end_orbit                     | long*  | all           | Array of orbit numbers for the end of the segments  | -             | >0                      |
| end_second                    | long*  | all           | Array of seconds elapsed since ANX for the end of the segments  | -             | >0<br><nodal period     |
| end_microsec                  | long*  | all           | Array of microseconds within a second for the end of the segments   | -             | >0<br><999999           |
| end_cycle                     | long*  | all           | Array of cycle numbers for the end of the segments.   | -             | >0 or NULL              |
| nb_zon_in_segment             | long*  | all           | Number of zones where the segment has visibility.<br>Dummy if extra_info_flag=0 (false).                    | -             | >0                      |
| zones_in_segment              | long** | all           | Index of the zone_id input array where the segment has visibility.<br>Dummy if extra_info_flag=0 (false).   | -             | ≥0                      |
| coverage                      | long** | all           | Coverage of the segment in each of the zones.<br>Dummy if extra_info_flag=0 (false).                        |               | complete<br>See Table 3 |
| ierr                          | long*  |               | Error status flags  |               |                         |

---

Note 1: The zones\_in\_segment and coverage arrays are returned as a two-dimensional table where the first index is related to the output visibility segment, and the second one goes all over the zones that compose that segment.

Note2 (Memory Management): Note that the output visibility segments arrays are pointers to integers instead of static arrays. The memory for these dynamic arrays is allocated within the **xv\_multizones\_vis\_time** function. So the user will only have to declare those pointers but not to allocate memory for them. However, once the function has returned without error, the user will have the responsibility of freeing the memory for those pointers once they are not used.

### 7.11.5 Warnings and errors

Next table lists the possible error messages that can be returned by the `xv_multizones_vis_time` CFI function after translating the returned status vector into the equivalent list of error messages by calling the function of the `EO_VISIBILITY` software library `xv_get_msg`.

This table also indicates the type of message returned, i.e. either a warning (WARN) or an error (ERR), the cause of such a message and the impact on the performed calculation, mainly on the results vector.

The table is completed by the error code and value. These error codes can be obtained translating the status vector returned by the `xv_multizones_vis_time` CFI function by calling the function of the `EO_VISIBILITY` software library `xv_get_code`.

**Table 39: Error messages and codes**

| Error type | Error message  | Cause and impact          | Error Code   | Error No |
|------------|--|---------------------------|--|----------|
| ERR        | Error allocating internal memory.                                    | Computation not performed | XV_CFI_MULTIZONE<br>S_VIS_TIME_MEMOR<br>Y_ERR            | 0        |
| ERR        | Error getting visibility segments for zone %ld                       | Computation not performed | XV_CFI_MULTIZONE<br>S_VIS_TIME_COMPUT<br>E_SEGMENTS_ERR  | 1        |
| ERR        | Error getting absolute orbit from relative orbit                     | Computation not performed | XV_CFI_MULTIZONE<br>S_VIS_TIME_ABS_TO<br>_REL_ORBIT_ERR  | 2        |
| ERR        | Error getting relative orbit vector from absolute orbits             | Computation not performed | XV_CFI_MULTIZONE<br>S_VIS_TIME_ABS_TO<br>_REL_VECTOR_ERR | 3        |
| ERR        | Error while merging overlapped segments                              | Computation not performed | XV_CFI_MULTIZONE<br>S_VIS_TIME_OVERLA<br>P_ERR           | 4        |
| ERR        | Orbit id is not initialized.   | Computation not performed | XV_CFI_MULTIZONES_VIS<br>_TIME_ORBIT_STATUS_E<br>RR      | 5        |
| ERR        | Geostationary satellite not allowed for this function.               | Computation not performed | XV_CFI_MULTIZONES_VIS<br>_TIME_GEO_SAT_ERR               | 6        |
| WARN       | Deprecated function. Use <code>xv_zonevistime_compute</code> instead | Computation performed     | XV_CFI_MULTIZONES_DE<br>PRECATED_WARN                    | 7        |

## 7.12xv\_multistations\_vis\_time

### 7.12.1 Overview

**Note:** this function is deprecated. Use `xv_stationvistime_compute` instead.

The `xv_multistations_vis_time` function computes visibility segments of several ground stations, i.e. the orbital segments for which the satellite is visible from a ground station located at the surface of the Earth.

The visibility segments are obtained by calling to `xv_station_vis_time`. Those segments are merged and ordered by start time. Moreover, `xv_multistations_vis_time` provides a table containing the stations from which the satellite is visible in each segment.

In addition, `xv_multistations_vis_time` computes the time of zero-doppler (i.e. the time at which the range-rate to the station is zero) per station.

The time intervals used by `xv_multistations_vis_time` are expressed in absolute orbit numbers or in relative orbit and cycle numbers. This is valid for both:

- input parameter “Orbit Range”: first and last orbit to be considered. In case of using relative orbits, the corresponding cycle number should be used, otherwise, this the cycle number will be a dummy parameter.
- output parameter “Stations Visibility Segments”: time segments with time expressed as {absolute orbit number (or relative orbit number and cycle number), number of seconds since ascending node, number of microseconds}

The orbit representation (absolute or relative) for the output segments will be the same as in the input orbits.

`xv_multistations_vis_time` requires access to several data structures and files to produce its results:

- the `orbit_id` (`xo_orbit_id`) providing the orbital data. The `orbit_id` can be initialized with the following data or files (see [ORBIT\_SUM]):
  - data for an orbital change
  - Orbit scenario files
  - Predicted orbit files
  - Orbit Event Files (**Note: Orbit Event File is deprecated, only supported for CRYOSAT mission**)
  - Restituted orbit files
  - DORIS Preliminary orbit files
  - DORIS Navigator files

Note: if the orbit is initialized for precise propagation, the execution of the visibility function can be very slow. As alternative, a POF can be generated with the precise propagator (function `xo_gen_pof`) for the range of orbits the user usually needs, and use this generated file to initialize the orbit id. The execution time performance will be much better for the visibility function and it will not have a big impact on the precision of the calculations.

- the Instrument Swath File, excluding inertial swath files, describing the area seen by the relevant instrument all along the current orbit. The Swath data can be provided by:
  - A swath template file produced off-line by the EO\_VISIBILITY library (`xv_gen_swath` function).
  - A swath definition file, describing the swath geometry. In this case the `xv_multistations_vis_time` generates the swath points for a number of orbits given by the user.

- the Instrument Swath File, excluding inertial swath files, describing the area seen by the relevant instrument all along the current orbit. It is produced off-line by the EO\_VISIBILITY library (**xv\_gen\_swath** function).
- the Station Database File, describing the location and the physical mask of each ground station.

Users who need to use processing times must make use of the conversion routines provided in EO\_ORBIT (**xo\_time\_to\_orbit** and **xo\_orbit\_to\_time** functions).

**NOTE:** If **xv\_multistation\_vis\_time** is used with a range of orbits that includes an orbital change (e.g. change in the repeat cycle or cycle length), the behaviour depends on the swath files introduced as input:

•If a **swath template file** is used, **xv\_multistation\_vis\_time** automatically will ignore the orbits that do not correspond with the template file (i.e. no visibility segments will be generated for those orbits), since swath template file is generated from a reference orbit with a particular geometry, so it is not valid for a different geometry.

•If a **swath definition file** is introduced, **xv\_multistation\_vis\_time** will perform the computations across orbital changes, and will return the visibility segments corresponding to the whole orbital range. Internally, swath templates valid for every orbital change are generated to perform the calculations.

## 7.12.2 Calling sequence *xv\_multistations\_vis\_time*

For C programs, the call to `xv_multistations_vis_time` is (input parameters are underlined):

```
#include "explorer_visibility.h"
{
    xo_orbit_id orbit_id = {NULL};
    long    swath_flag, orbit_type,
           start_orbit, start_cycle,
           stop_orbit, stop_cycle,
           num_stations, *mask,
           extra_info_flag,
           number_segments,
           *bgn_orbit, *bgn_secs, *bgn_microsecs, *bgn_cycle,
           *end_orbit, *end_secs, *end_microsecs, *end_cycle,
           **zdop_orbit, **zdop_secs, **zdop_microsecs, **zdop_cycle,
           *nb_stat_in_segment, **stat_in_segment,
           ierr[XV_NUM_ERR_MULTISTATIONS_VIS_TIME], status;

    double  *aos_elevation, *los_elevation,
           min_duration;

    char    *swath_file, *station_db_file,
           **station_id;

    status = xv_multistations_vis_time(
        &orbit_id, &orbit_type,
        &start_orbit, &start_cycle,
        &stop_orbit, &stop_cycle,
        &swath_flag, swath_file, &num_stations,
        station_db_file, station_id,
        aos_elevation, los_elevation, mask,
        &min_duration,
        &extra_info_flag,
        &number_segments,
        &bgn_orbit, &bgn_second, &bgn_microsec, &bgn_cycle,
        &end_orbit, &end_second, &end_microsec, &end_cycle,
        &zdop_orbit, &zdop_second, &zdop_microsec, &zdop_cycle,
        &nb_stat_in_segment, &stat_in_segment,
        ierr);
}
```



```
/* Or, using the run_id */  
long run_id;  
  
status = xv_multistations_vis_time_run(  
    &run_id, &orbit_type,  
    &start_orbit, &start_cycle,  
    &stop_orbit, &stop_cycle,  
    &swath_flag, swath_file, &num_stations,  
    station_db_file, station_id,  
    aos_elevation, los_elevation, mask,  
    &min_duration,  
    &extra_info_flag,  
    &number_segments,  
    &bgn_orbit, &bgn_second, &bgn_microsec, &bgn_cycle,  
    &end_orbit, &end_second, &end_microsec, &end_cycle,  
    &zdop_orbit, &zdop_second, &zdop_microsec, &zdop_cycle,  
    &nb_stat_in_segment, &stat_in_segment,  
    ierr);  
}
```

### 7.12.3 Input parameters *xv\_multistations\_vis\_time*

Table 40: Input parameters of *xv\_multistations\_vis\_time*

| C name        | C type       | Array Element | Description  | Unit (Format)                     | Allowed Range   |
|---------------|--------------|---------------|--|-----------------------------------|---|
| orbit_id      | xo_orbit_id* | -             | Structure that contains the orbit data   | -                                 | -   |
| orbit_type    | long         | -             | Define the type of orbit representation, i.e. absolute or relative orbits in the input/output parameters   | -                                 | Complete (see Table 3)  |
| start_orbit   | long         | -             | First orbit, segment filter<br><br>Segments will be filtered as from the beginning of first orbit (within orbit range from orbit_scenario_file)<br><br>First Orbit in the orbit_scenario_file will be used when: <ul style="list-style-type: none"> <li>Absolute orbit is set to zero.</li> <li>Relative orbit and cycle number set to zero.</li> </ul>  | absolute or relative orbit number | = 0<br>or:<br><ul style="list-style-type: none"> <li>absolute orbits <math>\geq</math> start_osf</li> <li>relative orbits <math>\leq</math> repeat cycle</li> </ul> |
| • start_cycle | long         | -             | Cycle number corresponding to the start_orbit. Dummy when using relative orbits  | cycle number                      | = 0 or $\geq$ first cycle in osf  |
| stop_orbit    | long         | -             | Last orbit, segment filter.<br><br>When: <ul style="list-style-type: none"> <li>stop_orbit = 0 (for orbit_type = XV_ORBIT_ABS)</li> <li>stop_orbit = 0 and stop_cycle = 0 (for orbit_type = XV_ORBIT_REL)</li> </ul> the stop_orbit will be set to the minimum value between: <ul style="list-style-type: none"> <li>the last orbit within the orbital change of the start_orbit.</li> <li>start_orbit+cycle_length-1 (i.e. the input orbit range will be a complete cycle)</li> </ul> | absolute or relative orbit number | = 0<br>or:<br><ul style="list-style-type: none"> <li>absolute orbits <math>\geq</math> start_osf</li> <li>relative orbits <math>\leq</math> repeat cycle</li> </ul> |
| stop_cycle    | long         | -             | Cycle number corresponding to the stop_orbit. Dummy when using relative orbits   | cycle number                      | = 0 or $\geq$ first cycle in osf  |
| swath_flag    | long*        | -             | Define the use of the swath file: <ul style="list-style-type: none"> <li>0 = (XV_STF) if the swath file is a swath template file.</li> <li>&gt; 0 if the swath files is a swath</li> </ul>   | -                                 | XV_STF = 0<br>XV_SDF = 1<br>> 0   |

|                 |         |     |  |     |                          |
|-----------------|---------|-----|--|-----|--------------------------|
|                 |         |     | definition file. In this case the swath points are generated for every "swath_flag" orbits   |     |                          |
| swath_file      | char *  | -   | File name of the swath-file for the appropriate instrument mode  |     |                          |
| num_stations    | long    | -   | Number of stations   |     | >0                       |
| station_db_file | char *  | -   | File name of the station-database file.  |     |                          |
| station_id      | char**  | -   | Identification name for n-th station (0<n<num_stations).   |     |                          |
| aos_elevation   | double* | all | Minimum elevation to consider at AOS for each station(i.e. before considering start of visibility).  | deg | ≥ 0.0                    |
| los_elevation   | double* | all | Maximum elevation to consider at LOS for each station(i.e. before considering end of visibility).  | deg | ≥ 0.0<br>≤ aos_elevation |
| mask            | long*   | all | mask used to define visibility<br>= 0 combine AOS/LOS elevations and physical mask (nominal mode)<br>= 1 consider only AOS/LOS elevations<br>= 2 consider only physical mask |     | ≥ 0                      |
| min_duration    | double  | -   | Minimum duration for segments.<br>Only segments with a duration longer than min_duration will be given on output.  | s   | ≥ 0                      |
| extra_info_flag | long    | -   | If value set to false (= 0), the zero doppler arrays and stations arrays are not computed.<br>Saves computation time.  |     | 0(false), 1 (true)       |

## 7.12.4 Output parameters *xv\_multistations\_vis\_time*

Table 41: Output parameters of *xv\_multistations\_vis\_time*

| C name                           | C type | Array Element | Description   | Unit (Format) | Allowed Range            |
|----------------------------------|--------|---------------|---|---------------|--------------------------|
| <i>xv_multistations_vis_time</i> | long   |               | Function status flag,<br>= 0 No error<br>> 0 Warnings, results generated<br>< 0 Error, no results generated   |               |                          |
| <i>number_segments</i>           | long   | -             | Number of segments in the output lists.   | -             | > 0                      |
| <i>bgn_orbit</i>                 | long*  | all           | Array of orbit numbers for the beginning of the segments  | -             | >0                       |
| <i>bgn_second</i>                | long*  | all           | Array of seconds elapsed since ANX for the beginning of the segments  | -             | >0<br><nodal period      |
| <i>bgn_microsec</i>              | long*  | all           | Array of micro seconds within a second for the beginning of the segments  | -             | >0<br><999999            |
| <i>bgn_cycle</i>                 | long*  | all           | Array of cycle numbers for the beginning of the segments.   | -             | >0                       |
| <i>end_orbit</i>                 | long*  | all           | Array of orbit numbers for the end of the segments  | -             | >0                       |
| <i>end_second</i>                | long*  | all           | Array of seconds elapsed since ANX for the end of the segments  | -             | >0<br><nodal period      |
| <i>end_microsec</i>              | long*  | all           | Array of micro seconds within a second for the end of the segments  | -             | >0<br><999999            |
| <i>end_cycle</i>                 | long*  | all           | Array of cycle numbers for the end of the segments.   | -             | >0 or NULL               |
| <i>zdop_orbit</i>                | long** | all           | Orbit number,<br>time of zero doppler for each segment and zone (-1 if no zero doppler within corresponding visibility segment)<br>Dummy if <i>extra_info_flag</i> = false.                 |               | > 0                      |
| <i>zdop_second</i>               | long** | all           | Seconds since ascending node,<br>time of zero doppler for each segment and zone (-1 if no zero doppler within corresponding visibility segment)<br>Dummy if <i>extra_info_flag</i> = false. | s             | >= 0<br>< orbital period |

|                    |        |     |   |    |                                       |
|--------------------|--------|-----|---|----|---------------------------------------|
| z dop_microsec     | long** | all | Micro seconds within second time of zero doppler for each segment and zone (-1 if no zero doppler within corresponding visibility segment)<br>Dummy if extra_info_flag = false. | μs | 0 =<=< 999999                         |
| z dop_cycle        | long** | all | Cycle number, time of zero doppler for each segment and zone (-1 if no zero doppler within corresponding visibility segment)<br>Dummy if extra_info_flag = false.               |    | >0<br>NULL when using absolute orbits |
| nb_stat_in_segment | long*  | all | nb_stat_in_segment [i] =Number of stations from which the satellite is visible during the i-th segment of time.<br>Dummy if extra_info_flag = false.                            | -  | >0                                    |
| stat_in_segment    | long** | all | stat_in_segment [i] = array of indexes of the stations from which the satellite is visible during the i-th segment.<br>Dummy if extra_info_flag = false.                        | -  | ≥0                                    |
| ierr               | long*  |     | Error status flags  |    |                                       |

Note 1: The stat\_in\_segment and z dop\_xxx arrays are returned as a two-dimensional table where the first index is related to the output visibility segment , and the second one goes all over the zones that compose that segment.

Note 2 (Memory Management): Note that the output visibility segments arrays are pointers to integers instead of static arrays. The memory for these dynamic arrays is allocated within the **xv\_multistations\_vis\_time** function. So the user will only have to declare those pointers but not to allocate memory for them. However, once the function has returned without error, the user will have the responsibility of freeing the memory for those pointers once they are not used.

### 7.12.5 Warnings and errors

Next table lists the possible error messages that can be returned by the `xv_multistations_vis_time` CFI function after translating the returned status vector into the equivalent list of error messages by calling the function of the `EO_VISIBILITY` software library `xv_get_msg`.

This table also indicates the type of message returned, i.e. either a warning (WARN) or an error (ERR), the cause of such a message and the impact on the performed calculation, mainly on the results vector.

The table is completed by the error code and value. These error codes can be obtained translating the status vector returned by the `xv_multistations_vis_time` CFI function by calling the function of the `EO_VISIBILITY` software library `xv_get_code`.

**Table 42: Error messages and codes**

| Error type | Error message   | Cause and impact          | Error Code  | Error No |
|------------|---|---------------------------|---|----------|
| ERR        | Error allocating internal memory.                                       | Computation not performed | XV_CFI_MULTISTATIONS_VIS_TIME_MEMORY_ERR            | 0        |
| ERR        | Error getting visibility segments for station %ld                       | Computation not performed | XV_CFI_MULTISTATIONS_VIS_TIME_COMPUTE_SEGMENTS_ERR  | 1        |
| ERR        | Error getting absolute orbit from relative orbit                        | Computation not performed | XV_CFI_MULTISTATIONS_VIS_TIME_ABS_TO_REL_ORBIT_ERR  | 2        |
| ERR        | Error getting relative orbit vector from absolute orbits.               | Computation not performed | XV_CFI_MULTISTATIONS_VIS_TIME_ABS_TO_REL_VECTOR_ERR | 3        |
| ERR        | Error while merging overlapped segments.                                | Computation not performed | XV_CFI_MULTISTATIONS_VIS_TIME_OVERLAP_ERR           | 4        |
| ERR        | Orbit id not initialized.   | Computation not performed | XV_CFI_MULTISTATIONS_VIS_TIME_ORBIT_STATUS_ERR      | 5        |
| ERR        | Geostationary satellite not allowed for this function.                  | Computation not performed | XV_CFI_MULTISTATIONS_VIS_TIME_GEO_SAT_ERR           | 6        |
| WARN       | Deprecated function. Use <code>xv_stationvistime_compute</code> instead | Computation performed     | XV_CFI_MULTISTATIONS_VIS_TIME_DEPRECATED_WARN       | 7        |

## 7.13 xv\_orbit\_extra

### 7.13.1 Overview

The **xv\_orbit\_extra** function computes for an input orbit, the times for:

- an input set of Sun zenith angles are reached (both up and down times are computed)
- Sun occultations by the Earth.
- Sun occultations by the Moon.

**xv\_orbit\_extra** needs as input the orbital parameters returned by **xo\_orbit\_info** (its output array **result\_vector**). So, the natural use to call to **xv\_orbit\_extra** will be:

- Initialise time references: calling to **xl\_time\_ref\_init** of **xl\_time\_ref\_init\_file**.
- Orbital initialisation by calling one of the functions: **xo\_orbit\_init\_file**, **xo\_orbit\_init\_def** or **xo\_orbit\_cart\_init**.
- Call to **xo\_orbit\_info** to get the **result\_vector** containing the orbital parameters of the orbit.
- Call to **xv\_orbit\_extra** with the same orbit than in the call to the **orbit\_info** function.

The input orbit must be an absolute orbit.

Users who need to use processing times must make use of the conversion routines provided in EO\_ORBIT (**xo\_time\_to\_orbit** and **xo\_orbit\_to\_time** functions).

### 7.13.2 Calling sequence *xv\_orbit\_extra*

For C programs, the call to `xv_orbit_extra` is (input parameters are underlined):

```
#include "explorer_visibility.h"
{

    xo_orbit_id orbit_id = {NULL};
    long        orbit,
               num_sza,
               ierr[XV_NUM_ERR_ORBIT_EXTRA];
    double      orbit_info_vector[XO_ORBIT_INFO_EXTRA_NUM_ELEMENTS], *sza,
               *sza_up, *sza_down,
               eclipse_entry, eclipse_exit,
               sun_moon_entry, sun_moon_exit;

    status= xv_orbit_extra (&orbit_id, &orbit, orbit_info_vector,
                           &num_sza, sza,
                           &sza_up, &sza_down,
                           &eclipse_entry, &eclipse_exit,
                           &sun_moon_entry, &sun_moon_exit,
                           ierr);

    /* Or, using the run_id */
    long run_id;

    status= xv_orbit_extra_run (&run_id, &orbit, orbit_info_vector,
                                &num_sza, sza,
                                &sza_up, &sza_down,
                                &eclipse_entry, &eclipse_exit,
                                &sun_moon_entry, &sun_moon_exit,
                                ierr);
}
```



### 7.13.3 Input parameters *xv\_orbit\_extra*

Table 43: Input parameters of *xv\_orbit\_extra*

| C name  | C type       | Array Element | Description                                 | Unit (Format)               | Allowed Range |
|---|--------------|---------------|---|-----------------------------|---------------|
| orbit_id  | xo_orbit_id* | -             | Structure that contains the orbit data      | -                           | -             |
| orbit   | long         | -             | absolute orbit number                       |                             | ≥ start osf   |
| orbit_info_vector<br>[XO_ORBIT_IN<br>FO_EXTRA_NUM_ELEMENTS] | double       | [0]           | repeat_cycle                                | days                        | >0            |
|   |              | [1]           | cycle_length                                | orbits                      | >0            |
|   |              | [2]           | MLST drift                                  |                             | s/day         |
|   |              | [3]           | MLST  | deg                         | > 0<br><360   |
|   |              | [4]           | phasing                                     | deg                         | > 0<br><360   |
|   |              | [5]           | UTC time at ascending node                  | days<br>(processing format) |               |
|   |              | [6-8]         | position at ANX                             | m                           |               |
|   |              | [9-11]        | velocity at ANX                             | m/s                         |               |
|   |              | [12-17]       | mean keplerian elements at ANX              |                             |               |
|   |              | [18-23]       | osculating keplerian elements at ANX        |                             |               |
|   |              | [24]          | Nodal period                                | s                           |               |
| num_sza   | long         | -             | Number of Sun Zenit angles in the sza array | -                           | >0            |
| sza   | double*      | all           | list of Sun Zenit angles to compute         | deg                         | ≥ 0<br>≤ 180  |

### 7.13.4 Output parameters *xv\_orbit\_extra*

Table 44: Output parameters of *xv\_orbi\_extra*

| C name                | C type | Array Element | Description   | Unit (Format) | Allowed Range   |
|-----------------------|--------|---------------|---|---------------|---|
| <i>xv_orbit_extra</i> | long   | -             | Function status flag,<br>= 0 No error<br>> 0 Warnings, results generated<br>< 0 Error, no results generated   |               |   |
| <i>sza_up</i>         | double | all           | Seconds since ANX of Sun Zenith Angles when SZA is increasing with time.  | s             | ≥ 0<br>≤ orb. period                                      |
| <i>sza_down</i>       | double | all           | Seconds since ANX of Sun Zenith Angles when SZA is decreasing with time.  | s             | ≥ 0<br>≤ orb. period                                      |
| <i>eclipse_entry</i>  | double | -             | Seconds since ANX of eclipse entry.<br><br>Note that the value is provided within the input orbit, so that the <i>eclipse_exit</i> will be less than the <i>eclipse_entry</i> if the ANX is in eclipse. | s             | ≥ 0<br>≤ orbital period<br>-1 if there is not eclipse     |
| <i>eclipse_exit</i>   | double | -             | Seconds since ANX of eclipse exit. Note that the value is provided within the input orbit, so that the <i>eclipse_exit</i> will be less than the <i>eclipse_entry</i> if the ANX is in eclipse.         | s             | ≥ 0<br>≤ orbital period<br>-1 if there is not eclipse     |
| <i>sun_moon_entry</i> | double | -             | Seconds since ANX of Sun Occultation by Moon entry.   | s             | <-1 if no occultation is found<br>≥ 0<br>≤ orbital period |
| <i>sun_moon_exit</i>  | double | -             | Seconds since ANX of Sun Occultation by Moon exit   | s             | <-1 if no occultation is found<br>≥ 0<br>≤ orbital period |
| <i>ierr</i>           | long*  |               | Error status flags  |               |   |

**Note (Memory Management):** Note that the *sza\_up* and *sza\_down* arrays are pointers instead of static arrays. The memory for these dynamic arrays is allocated within the *xv\_orbit\_extra* function. So the user

---

will only have to declare those pointers but not to allocate memory for them. However, once the function has returned without error, the user will have the responsibility of freeing the memory for those pointers once they are not used.

### 7.13.5 Warnings and errors

Next table lists the possible error messages that can be returned by the `xv_orbit_extra` CFI function after translating the returned status vector into the equivalent list of error messages by calling the function of the EO\_VISIBILITY software library `xv_get_msg`.

This table also indicates the type of message returned, i.e. either a warning (WARN) or an error (ERR), the cause of such a message and the impact on the performed calculation, mainly on the results vector.

The table is completed by the error code and value. These error codes can be obtained translating the status vector returned by the `xv_orbit_extra` CFI function by calling the function of the EO\_VISIBILITY software library `xv_get_code`.

**Table 45: Error messages and codes**

| Error type | Error message                                    | Cause and impact          | Error Code                                     | Error No |
|------------|--|---------------------------|--|----------|
| ERR        | Wrong input orbit Id.                            | Computation not performed | XV_CFI_ORBIT_EXTR<br>A_ORBIT_STATUS_ERR        | 0        |
| ERR        | Error allocating memory for SZA entry/exit times | Computation not performed | XV_CFI_ORBIT_EXTR<br>A_MEM_ERR                 | 1        |
| ERR        | Error computing SZA entry/exit times             | Computation not performed | XV_CFI_ECLIPSE_XL_<br>EF_TO_QEF_ERR            | 2        |
| ERR        | Error computing eclipse entry/exit times         | Computation not performed | XV_CFI_ORBIT_EXTR<br>A_ECLIPSE_ERR             | 3        |
| ERR        | Error computing Sun occultation by Moon.         | Computation not performed | XV_CFI_ORBIT_EXTR<br>A_SUN_OCC_BY_MO<br>ON_ERR | 4        |

## 7.14 xv\_gps\_vis\_time

TBW

## 7.15 xv\_time\_segments\_not

### 7.15.1 Overview

**Note:** this function is deprecated. Use `xv_timesegments_compute_not` instead.

An orbital segment is a time interval along the orbit, defined by start and stop times expressed as an orbit number and the seconds elapsed since the ascending node crossing.

The `xv_time_segments_not` function computes the compliment of a list of orbital segments (see Figure 22)

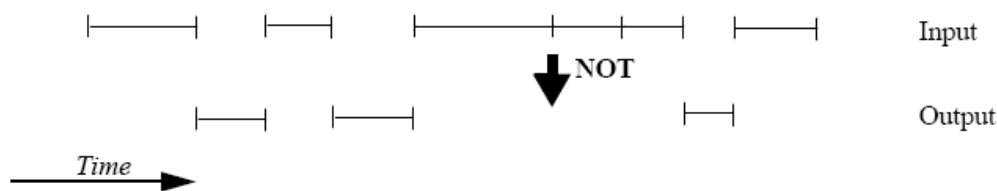

**Figure 22: xv\_time\_segment\_not\_function**

Note that the intervals from the first orbit to the first segment and from the last segment to the end of mission are not returned.

The input segments list need to be sorted according to the start time of the segments. If this list is not sorted, it should be indicated in the function interface with the corresponding parameter (see below). In this case the input list will be modified accordingly.

The time intervals used by `xv_time_segments_not` can be expressed in absolute or relative orbit numbers. This is valid for both:

- input parameter: first and last orbit to be considered. In case of using relative orbits, the corresponding cycle numbers should be used, otherwise, the cycle number will be a dummy parameter.
- output parameter: time segments with time expressed as {absolute orbit number (or relative orbit and cycle number), number of seconds since ANX, number of micro seconds}

The orbit representation (absolute or relative) for the output segments will be the same as in the input orbits. Moreover, the segments will be ordered chronologically.

The `xv_time_segments_not` requires access to the following files to produce its results:

- the Orbit Scenario File: only if the orbits are expressed in relative numbers.

## 7.15.2 Calling sequence `xv_time_segments_not`

For C programs, the call to `xv_time_segments_not` is (input parameters are underlined):

```
#include "explorer_visibility.h"
{

    xo_orbit_id orbit_id = {NULL};
    long    orbit_type, order_switch,
           num_segments_in,
           *bgn_orbit_in, *bgn_secs_in,
           *bgn_microsecs_in, *bgn_cycle_in,
           *end_orbit_in, *end_secs_in,
           *end_microsecs_in, *end_cycle_in,
           num_segments_out,
           *bgn_orbit_out, *bgn_secs_out,
           *bgn_microsecs_out, *bgn_cycle_out,
           *end_orbit_out, *end_secs_out,
           *end_microsecs_out, *end_cycle_out,
           ierr[XV_NUM_ERR_NOT], status;

    status = xv_time_segments_not(
        &orbit_id,
        &orbit_type, &order_switch,
        &number_segments_in,
        bgn_orbit_in, bgn_secs_in,
        bgn_microsecs_in, bgn_cycle_in,
        end_orbit_in, end_secs_in,
        end_microsecs_in, end_cycle_in,
        &num_segments_out,
        &bgn_orbit_out, &bgn_secs_out,
        &bgn_microsecs_out, &bgn_cycle_out,
        &end_orbit_out, &end_secs_out,
        &end_microsecs_out, &end_cycle_out,
        ierr);

    /* Or, using the run_id */
    long run_id;
```

```
status = xv_time_segments_not_run(  
    &run_id,  
    &orbit_type, &order_switch,  
    &number_segments_in,  
    bgn_orbit_in, bgn_secs_in,  
    bgn_microsecs_in, bgn_cycle_in,  
    end_orbit_in, end_secs_in,  
    end_microsecs_in, end_cycle_in,  
    &num_segments_out,  
    &bgn_orbit_out, &bgn_secs_out,  
    &bgn_microsecs_out, &bgn_cycle_out,  
    &end_orbit_out, &end_secs_out,  
    &end_microsecs_out, &end_cycle_out,  
    ierr);  
}
```



### 7.15.3 Input parameters *xv\_time\_segments\_not*

Table 46: Input parameters of *xv\_time\_segments\_not*

| C name           | C type       | Array Element | Description   | Unit (Format) | Allowed Range          |
|------------------|--------------|---------------|---|---------------|------------------------|
| orbit_id         | xo_orbit_id* | -             | Structure that contains the orbit data  | -             | -                      |
| orbit_type       | long         | -             | Define the type of orbit representation, i.e. absolute or relative orbits in the input/output parameters  | -             | Complete (see Table 3) |
| order_switch     | long         | -             | Indicates if the input list is sorted by start times. If input segments are already sorted, the flag should be set to XV_TIME_ORDER to save computation time. | -             | Complete (see Table 3) |
| num_segments_in  | long         | -             | Number of segments in the input list.   | -             | >0                     |
| bgn_orbit_in     | long*        | all           | Array of orbit numbers for the beginning of the segments  | -             | >0                     |
| bgn_secs_in      | long*        | all           | Array of seconds elapsed since ANX for the beginning of the segments  | -             | >0<br><nodal period    |
| bgn_microsecs_in | long*        | all           | Array of microseconds within a second for the beginning of the segments   | -             | >0<br><999999          |
| bgn_cycle_in     | long*        | all           | Array of cycle numbers for the beginning of the segments. When using absolute orbits, a NULL pointer can be used.   | -             | >0 or NULL             |
| end_orbit_in     | long*        | all           | Array of orbit numbers for the end of the segments  | -             | >0                     |
| end_secs_in      | long*        | all           | Array of seconds elapsed since ANX for the end of the segments  | -             | >0<br><nodal period    |
| end_microsecs_in | long*        | all           | Array of seconds within a second for the end of the segments  | -             | >0<br><999999          |
| end_cycle_in     | long*        | all           | Array of cycle numbers for the end of the segments. When using absolute orbits, a NULL pointer can be used.   | -             | >0 or NULL             |

## 7.15.4 Output parameters *xv\_time\_segments\_not*

Table 47: Output parameters of *xv\_time\_segments\_not*

| C name                      | C type | Array Element | Description   | Unit (Format) | Allowed Range       |
|-----------------------------|--------|---------------|---|---------------|---------------------|
| <i>xv_time_segments_not</i> | long   |               | Function status flag,<br>= 0 No error<br>> 0 Warnings, results generated<br>< 0 Error, no results generated |               |                     |
| <i>num_segments_out</i>     | long   | -             | Number of segments in the output list.  | -             | >0                  |
| <i>bgn_orbit_out</i>        | long*  | all           | Array of orbit numbers for the beginning of the segments  | -             | >0                  |
| <i>bgn_secs_out</i>         | long*  | all           | Array of seconds elapsed since ANX for the beginning of the segments  | -             | >0<br><nodal period |
| <i>bgn_microsecs_out</i>    | long*  | all           | Array of microseconds within a second for the beginning of the segments                                     | -             | >0<br>< 999999      |
| <i>bgn_cycle_out</i>        | long*  | all           | Array of cycle numbers for the beginning of the segments.   | -             | >0                  |
| <i>end_orbit_out</i>        | long*  | all           | Array of orbit numbers for the end of the segments  | -             | >0                  |
| <i>end_secs_out</i>         | long*  | all           | Array of seconds elapsed since ANX for the end of the segments  | -             | >0<br><nodal period |
| <i>end_microsecs_out</i>    | long*  | all           | Array of microseconds within a second for the end of the segments   | -             | >0<br>< 999999      |
| <i>end_cycle_out</i>        | long*  | all           | Array of cycle numbers for the end of the segments.   | -             | >0 or NULL          |
| <i>ierr[10]</i>             | long   |               | Error status flags  |               |                     |

**Memory Management:** Note that the output visibility segments arrays are pointers to integers instead of static arrays. The memory for these dynamic arrays is allocated within the *xv\_time\_segments\_not* function. So the user will only have to declare those pointers but not to allocate memory for them. However, once the function has returned without error, the user will have the responsibility of freeing the memory for those pointers once they are not used.

### 7.15.5 Warnings and errors

Next table lists the possible error messages that can be returned by the `xv_time_segments_not` CFI function after translating the returned status vector into the equivalent list of error messages by calling the function of the EO\_VISIBILITY software library `xv_get_msg`.

This table also indicates the type of message returned, i.e. either a warning (WARN) or an error (ERR), the cause of such a message and the impact on the performed calculation, mainly on the results vector.

The table is completed by the error code and value. These error codes can be obtained translating the status vector returned by the `xv_time_segments_not` CFI function by calling the function of the EO\_VISIBILITY software library `xv_get_code`.

**Table 48: Error messages and codes**

| Error type | Error message   | Cause and impact          | Error Code                                    | Error No |
|------------|---|---------------------------|---|----------|
| ERR        | Error allocating internal memory.   | Computation not performed | XV_CFI_TIME_SEGMENTS_NOT_MEMORY_ERR           | 0        |
| ERR        | Error getting absolute orbit vector from relative orbits.                 | Computation not performed | XV_CFI_TIME_SEGMENTS_NOT_REL_TO_ABS_ORBIT_ERR | 1        |
| ERR        | Error getting relative orbit vector from absolute orbits.                 | Computation not performed | XV_CFI_TIME_SEGMENTS_NOT_ABS_TO_REL_ORBIT_ERR | 2        |
| ERR        | Error sorting input list.   | Computation not performed | XV_CFI_TIME_SEGMENTS_NOT_SORTING_ERR          | 3        |
| ERR        | Geostationary satellite not allowed for this function.                    | Computation not performed | XV_CFI_TIME_SEGMENTS_NOT_GEO_SAT_ERR          | 4        |
| WARN       | Deprecated function. Use <code>xv_timesegments_compute_not</code> instead | Computation performed     | XV_CFI_TIME_SEGMENTS_NOT_DEPRECATED_WARN      | 5        |

## 7.16 xv\_timesegments\_compute\_not

### 7.16.1 Overview

An orbital segment is a time interval along the orbit, defined by start and stop times expressed as an orbit number and the seconds elapsed since the ascending node crossing.

The **xv\_timesegments\_compute\_not** function computes the compliment of a list of orbital segments (see Figure 23)

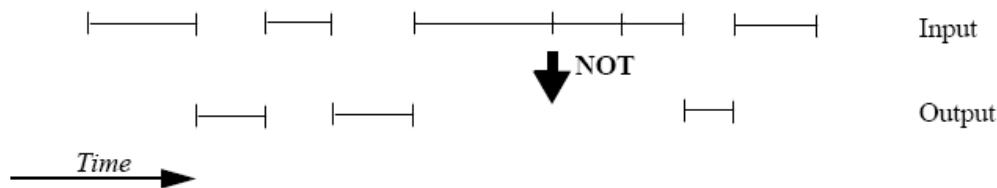

Figure 23: xv\_timesegments\_compute\_not function

Note that the intervals from the first orbit to the first segment and from the last segment to the end of mission are not returned.

The input segments list need to be sorted according to the start time of the segments. If this list is not sorted, it should be indicated in the function interface with the corresponding parameter (see below). In this case the input list will be modified accordingly.

The time intervals (**xv\_time\_interval**) used by **xv\_timesegments\_compute\_not** can be expressed as UTC times or orbit times (orbit plus seconds and microseconds since ascending node). This intervals express the start time/orbit and last time/orbit for the computations.

In case the time intervals are expressed as orbits, they can be expressed as absolute orbit numbers or in relative orbit and cycle numbers.

The orbit representation (absolute or relative) for the output segments will be the same as in the input orbits. The output segments will contain UTC times and orbit times. Moreover, the segments will be ordered chronologically.

The **xv\_timesegments\_compute\_not** requires access to the following files to produce its results:

- the Orbit Scenario File: only if the orbits are expressed in relative numbers.

### **7.16.2 Calling sequence `xv_timesegments_compute_not`**

For C programs, the call to `xv_timesegments_compute_not` is (input parameters are underlined):

```
#include "explorer_visibility.h"
{

    xo_orbit_id orbit_id = {NULL};
    long    order_switch;
    xv_visibility_interval_list seg_in;
    xv_visibility_interval_list seg_out;
    long ierr[XV_NUM_ERR_COMPUTE_NOT];
    long status;

    status = xv_timesegments_compute_not(
        &orbit_id, &order_switch,
        &seg_in,
        &seg_out, ierr);

    /* Or, using the run_id */
    long run_id;

    status = xv_timesegments_compute_not(
        &run_id, &order_switch,
        &seg_in,
        &seg_out, ierr);
```

### 7.16.3 Input parameters *xv\_timesegments\_compute\_not*

*Table 49: Input parameters of xv\_timesegments\_compute\_not*

| C name       | C type                      | Array Element | Description   | Unit (Format) | Allowed Range          |
|--------------|-----------------------------|---------------|---|---------------|------------------------|
| orbit_id     | xo_orbit_id*                | -             | Structure that contains the orbit data  | -             | -                      |
| order_switch | long                        | -             | Indicates if the input list is sorted by start times. If input segments are already sorted, the flag should be set to XV_TIME_ORDER to save computation time. | -             | Complete (see Table 3) |
| seg_in       | xv_visibility_interval_list | -             | Input list of segments  | -             | -                      |

## 7.16.4 Output parameters *xv\_timesegments\_compute\_not*

Table 50: Output parameters of *xv\_timesegments\_compute\_not*

| C name                             | C type                             | Array Element | Description   | Unit (Format) | Allowed Range |
|------------------------------------|------------------------------------|---------------|---|---------------|---------------|
| <i>xv_timesegments_compute_not</i> | long                               |               | Function status flag,<br>= 0 No error<br>> 0 Warnings, results generated<br>< 0 Error, no results generated |               |               |
| <i>seg_out</i>                     | <i>xv_visibility_interval_list</i> | -             | Output list of segments   | -             | -             |
| <i>ierr[]</i>                      | long                               |               | Error status flags  |               |               |

**Memory Management:** Note that the memory for the output visibility segments arrays is allocated within the *xv\_timesegments\_compute\_not* function. So the user will only have to declare those pointers but not to allocate memory for them. However, once the function has returned without error, the user will have the responsibility of freeing the memory for those pointers once they are not used.

### 7.16.5 Warnings and errors

Next table lists the possible error messages that can be returned by the `xv_timesegments_compute_not` CFI function after translating the returned status vector into the equivalent list of error messages by calling the function of the EO\_VISIBILITY software library `xv_get_msg`.

This table also indicates the type of message returned, i.e. either a warning (WARN) or an error (ERR), the cause of such a message and the impact on the performed calculation, mainly on the results vector.

The table is completed by the error code and value. These error codes can be obtained translating the status vector returned by the `xv_timesegments_compute_not` CFI function by calling the function of the EO\_VISIBILITY software library `xv_get_code`.

**Table 51: Error messages and codes**

| Error type | Error message   | Cause and impact          | Error Code   | Error No |
|------------|---|---------------------------|--|----------|
| ERR        | Error allocating internal memory.                         | Computation not performed | XV_CFI_TIMESEGMENTS_COMPUTE_NOT_MEMORY_ERR           | 0        |
| ERR        | Error getting absolute orbit vector from relative orbits. | Computation not performed | XV_CFI_TIMESEGMENTS_COMPUTE_NOT_REL_TO_ABS_ORBIT_ERR | 1        |
| ERR        | Error getting relative orbit vector from absolute orbits. | Computation not performed | XV_CFI_TIMESEGMENTS_COMPUTE_NOT_ABS_TO_REL_ORBIT_ERR | 2        |
| ERR        | Error sorting input list.                                 | Computation not performed | XV_CFI_TIMESEGMENTS_COMPUTE_NOT_SORTING_ERR          | 3        |
| ERR        | Geostationary satellite not allowed for this function.    | Computation not performed | XV_CFI_TIMESEGMENTS_COMPUTE_NOT_GEO_SAT_ERR          | 4        |
| ERR        | Error computing time to orbit parameters                  | Computation not performed | XV_CFI_TIMESEGMENTS_COMPUTE_NOT_TIME_TO_ORBIT_ERR    | 5        |
| ERR        | Error computing UTC time for orbit                        | Computation not performed | XV_CFI_TIMESEGMENTS_COMPUTE_NOT_GET_UTC_TIME_ERR     | 6        |



## 7.17 xv\_time\_segments\_or

### 7.17.1 Overview

**Note:** this function is deprecated. Use `xv_timesegments_compute_or` instead.

An orbital segment is a time interval along the orbit, defined by start and stop times expressed as an orbit number and the seconds elapsed since the ascending node crossing.

The `xv_time_segments_or` function computes the union of a list of orbital segments (see Figure 24)

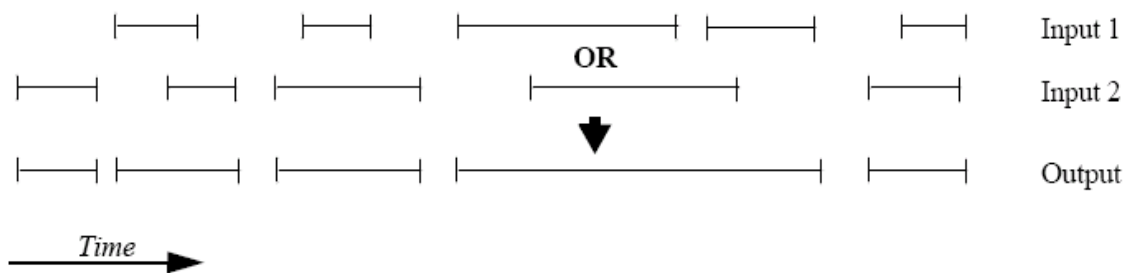

**Figure 24: xv\_time\_segments\_or\_function**

The input segments list need to be sorted according to the start time of the segments. If this list is not sorted, it should be indicated in the function interface with the corresponding parameter (see below). In this case the input list will be modified accordingly.

The time intervals used by `xv_time_segments_or` can be expressed in absolute or relative orbit numbers. This is valid for both:

- input parameter: first and last orbit to be considered. In case of using relative orbits, the corresponding cycle numbers should be used, otherwise, the cycle number will be a dummy parameter.
- output parameter: time segments with time expressed as {absolute orbit number (or relative orbit and cycle number), number of seconds since ANX, number of microseconds}

The orbit representation (absolute or relative) for the output segments will be the same as in the input orbits. Moreover, the segments will be ordered chronologically.

The `xv_time_segments_or` requires access to the following files to produce its results:

- the Orbit Scenario File: only if the orbits are expressed in relative numbers.

## 7.17.2 Calling sequence *xv\_time\_segments\_or*

For C programs, the call to `xv_time_segments_or` is (input parameters are underlined):

```
#include "explorer_visibility.h"
{

    xo_orbit_id orbit_id = {NULL};
    long        orbit_type, order_switch,
               num_segments_1,
               *bgn_orbit_1, *bgn_secs_1,
               *bgn_microsecs_1, *bgn_cycle_1,
               *end_orbit_1, *end_secs_1,
               *end_microsecs_1, *end_cycle_1,
               num_segments_2,
               *bgn_orbit_2, *bgn_secs_2,
               *bgn_microsecs_2, *bgn_cycle_2,
               *end_orbit_2, *end_secs_2,
               *end_microsecs_2, *end_cycle_2,
               num_segments_out,
               *bgn_orbit_out, *bgn_secs_out,
               *bgn_microsecs_out, *bgn_cycle_out,
               *end_orbit_out, *end_secs_out,
               *end_microsecs_out, *end_cycle_out,
               ierr[XV_NUM_ERR_OR], status;

    status = xv_time_segments_or (
        &orbit_id,
        &orbit_type, &order_switch,
        &number_segments_1,
        bgn_orbit_1, bgn_second_1,
        bgn_microsec_1, bgn_cycle_1,
        end_orbit_1, end_second_1,
        end_microsec_1, end_cycle_1,
        &number_segments_2,
        bgn_orbit_2, bgn_second_2,
        bgn_microsec_2, bgn_cycle_2,
        end_orbit_2, end_second_2,
        end_microsec_2, end_cycle_2,
        &num_segments_out,
```

```
&bgn_orbit_out, &bgn_secs_out,  
&bgn_microsecs_out, &bgn_cycle_out,  
&end_orbit_out, &end_secs_out,  
&end_microsecs_out, &end_cycle_out,  
ierr);  
  
/* Or, using the run_id */  
long run_id;  
  
status = xv_time_segments_or_run (  
    &run_id,  
    &orbit_type, &order_switch,  
    &number_segments_1,  
    bgn_orbit_1, bgn_second_1,  
    bgn_microsec_1, bgn_cycle_1,  
    end_orbit_1, end_second_1,  
    end_microsec_1, end_cycle_1,  
    &number_segments_2,  
    bgn_orbit_2, bgn_second_2,  
    bgn_microsec_2, bgn_cycle_2,  
    end_orbit_2, end_second_2,  
    end_microsec_2, end_cycle_2,  
    &num_segments_out,  
    &bgn_orbit_out, &bgn_secs_out,  
    &bgn_microsecs_out, &bgn_cycle_out,  
    &end_orbit_out, &end_secs_out,  
    &end_microsecs_out, &end_cycle_out,  
    ierr);  
  
}
```

### 7.17.3 Input parameters *xv\_time\_segments\_or*

Table 52: Input parameters of *xv\_time\_segments\_or*

| C name          | C type       | Array Element | Description  | Unit (Format) | Allowed Range          |
|-----------------|--------------|---------------|--|---------------|------------------------|
| orbit_id        | xo_orbit_id* | -             | Structure that contains the orbit data   | -             | -                      |
| orbit_type      | long         | -             | Define the type of orbit representation, i.e. absolute or relative orbits in the input/output parameters   | -             | Complete (see Table 3) |
| order_switch    | long         | -             | Indicates if the input list is sorted by start times. If input segments are already sorted, the flag should be set to <i>XV_TIME_ORDER</i> to save computation time. | -             | Complete (see Table 3) |
| num_segments_1  | long         | -             | Number of segments in the input list 1.  | -             | >0                     |
| bgn_orbit_1     | long*        | all           | Array of orbit numbers for the beginning of the segments in list 1   | -             | >0                     |
| bgn_secs_1      | long*        | all           | Array of seconds elapsed since ANX for the beginning of the segments in list 1   | -             | >0<br><nodal period    |
| bgn_microsecs_1 | long*        | all           | Array of microseconds within a second for the beginning of the segments in list 1  | -             | >0<br><999999          |
| bgn_cycle_1     | long*        | all           | Array of cycle numbers for the beginning of the segments in list 1. When using absolute orbits, a NULL pointer can be used.  | -             | >0 or NULL             |
| end_orbit_1     | long*        | all           | Array of orbit numbers for the end of the segments in list 1   | -             | >0                     |
| end_secs_1      | long*        | all           | Array of seconds elapsed since ANX for the end of the segments in list 1   | -             | >0<br><nodal period    |
| end_microsecs_1 | long*        | all           | Array of microseconds within a second for the end of the segments in list 1  | -             | >0<br><999999          |
| end_cycle_1     | long*        | all           | Array of cycle numbers for the end of the segments in list 1. When using absolute orbits, a NULL pointer can be used.  | -             | >0 or NULL             |
| num_segments_2  | long         | -             | Number of segments in the input list 2.  | -             | >0                     |

|                 |       |     |   |   |                     |
|-----------------|-------|-----|---|---|---------------------|
| bgn_orbit_2     | long* | all | Array of orbit numbers for the beginning of the segments in list 2  | - | >0                  |
| bgn_secs_2      | long* | all | Array of seconds elapsed since ANX for the beginning of the segments in list 2  | - | >0<br><nodal period |
| bgn_microsecs_2 | long* | all | Array of microseconds within a second for the beginning of the segments in list 2   | - | >0<br><999999       |
| bgn_cycle_2     | long* | all | Array of cycle numbers for the beginning of the segments in list 2. When using absolute orbits, a NULL pointer can be used. | - | >0 or NULL          |
| end_orbit_2     | long* | all | Array of orbit numbers for the end of the segments in list 2  | - | >0                  |
| end_secs_2      | long* | all | Array of seconds elapsed since ANX for the end of the segments in list 2  | - | >0<br><nodal period |
| end_microsecs_2 | long* | all | Array of microseconds within a second for the end of the segments in list 2   | - | >0<br><999999       |
| end_cycle_2     | long* | all | Array of cycle numbers for the end of the segments in list 2. When using absolute orbits, a NULL pointer can be used.       | - | >0 or NULL          |

## 7.17.4 Output parameters *xv\_time\_segments\_or*

Table 53: Output parameters of *xv\_time\_segments\_or*

| C name                     | C type | Array Element | Description   | Unit (Format ) | Allowed Range       |
|----------------------------|--------|---------------|---|----------------|---------------------|
| <i>xv_time_segments_or</i> | long   |               | Function status flag,<br>= 0 No error<br>> 0 Warnings, results generated<br>< 0 Error, no results generated |                |                     |
| <i>num_segments_out</i>    | long   | -             | Number of segments in the output list.  | -              | >0                  |
| <i>bgn_orbit_out</i>       | long*  | all           | Array of orbit numbers for the beginning of the segments  | -              | >0                  |
| <i>bgn_secs_out</i>        | long*  | all           | Array of seconds elapsed since ANX for the beginning of the segments  | -              | >0<br><nodal period |
| <i>bgn_microsecs_out</i>   | long*  | all           | Array of microseconds within a second for the beginning of the segments                                     | -              | >0<br><999999       |
| <i>bgn_cycle_out</i>       | long*  | all           | Array of cycle numbers for the beginning of the segments.   | -              | >0                  |
| <i>end_orbit_out</i>       | long*  | all           | Array of orbit numbers for the end of the segments  | -              | >0                  |
| <i>end_secs_out</i>        | long*  | all           | Array of seconds elapsed since ANX for the end of the segments  | -              | >0<br><nodal period |
| <i>end_microsecs_out</i>   | long*  | all           | Array of microseconds within a second for the end of the segments   | -              | >0<br><999999       |
| <i>end_cycle_out</i>       | long*  | all           | Array of cycle numbers for the end of the segments.   | -              | >0 or NULL          |
| <i>ierr[10]</i>            | long   |               | Error status flags  |                |                     |

**Memory Management:** Note that the output visibility segments arrays are pointers to integers instead of static arrays. The memory for these dynamic arrays is allocated within the *xv\_time\_segments\_or* function. So the user will only have to declare those pointers but not to allocate memory for them. However, once the function has returned without error, the user will have the responsibility of freeing the memory for those pointers once they are not used.

### 7.17.5 Warnings and errors

Next table lists the possible error messages that can be returned by the `xv_time_segments_or` CFI function after translating the returned status vector into the equivalent list of error messages by calling the function of the EO\_VISIBILITY software library `xv_get_msg`.

This table also indicates the type of message returned, i.e. either a warning (WARN) or an error (ERR), the cause of such a message and the impact on the performed calculation, mainly on the results vector.

The table is completed by the error code and value. These error codes can be obtained translating the status vector returned by the `xv_time_segments_or` CFI function by calling the function of the EO\_VISIBILITY software library `xv_get_code`.

**Table 54: Error messages and codes**

| Error type | Error message  | Cause and impact          | Error Code                                   | Error No |
|------------|--|---------------------------|--|----------|
| ERR        | Error allocating internal memory.  | Computation not performed | XV_CFI_TIME_SEGMENTS_OR_MEMORY_ERR           | 0        |
| ERR        | Error getting absolute orbit vector from relative orbits.                | Computation not performed | XV_CFI_TIME_SEGMENTS_OR_REL_TO_ABS_ORBIT_ERR | 1        |
| ERR        | Error getting relative orbit vector from absolute orbits.                | Computation not performed | XV_CFI_TIME_SEGMENTS_OR_ABS_TO_REL_ORBIT_ERR | 2        |
| ERR        | Error sorting input list.  | Computation not performed | XV_CFI_TIME_SEGMENTS_OR_SORTING_ERR          | 3        |
| ERR        | Geostationary satellite not allowed for this function.                   | Computation not performed | XV_CFI_TIME_SEGMENTS_OR_GEO_SAT_ERR          | 4        |
| WARN       | Deprecated function. Use <code>xv_timesegments_compute_or</code> instead | Computation performed     | XV_CFI_TIME_SEGMENTS_OR_DEPRECATED_WARN      | 5        |

## 7.18 xv\_timesegments\_compute\_or

### 7.18.1 Overview

An orbital segment is a time interval along the orbit, defined by start and stop times expressed as an orbit number and the seconds elapsed since the ascending node crossing.

The **xv\_timesegments\_compute\_or** function computes the union of a list of orbital segments (see Figure 25)

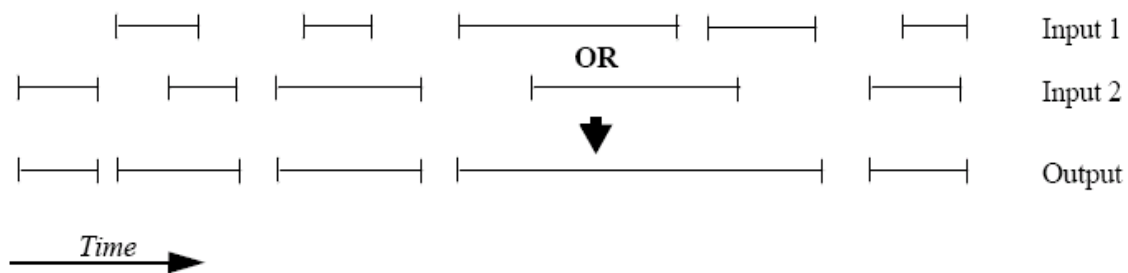

Figure 25: xv\_timesegments\_compute\_or\_function

The input segments list need to be sorted according to the start time of the segments. If this list is not sorted, it should be indicated in the function interface with the corresponding parameter (see below). In this case the input list will be modified accordingly.

The time intervals (**xv\_time\_interval**) used by **xv\_timesegments\_compute\_or** can be expressed as UTC times or orbit times (orbit plus seconds and microseconds since ascending node). This intervals express the start time/orbit and last time/orbit for the computations.

In case the time intervals are expressed as orbits, they can be expressed as absolute orbit numbers or in relative orbit and cycle numbers.

The orbit representation (absolute or relative) for the output segments will be the same as in the input orbits. The output segments will contain UTC times and orbit times. Moreover, the segments will be ordered chronologically.

The **xv\_timesegments\_compute\_or** requires access to the following files to produce its results:

- the Orbit Scenario File: only if the orbits are expressed in relative numbers.



## 7.18.2 Calling sequence *xv\_timesegments\_compute\_or*

For C programs, the call to `xv_timesegments_compute_or` is (input parameters are underlined):

```
#include "explorer_visibility.h"
{

    xo_orbit_id orbit_id = {NULL};
    long    order_switch;
    xv_visibility_interval_list seg_in1, seg_in2;
    xv_visibility_interval_list seg_out;
    long ierr[XV_NUM_ERR_COMPUTE_NOT];
    long status;

    status = xv_timesegments_compute_not(
        &orbit_id, &order_switch,
        &seg_in1, &seg_in2
        &seg_out, ierr);

    /* Or, using the run_id */
    long run_id;

    status = xv_timesegments_compute_not(
        &run_id, &order_switch,
        &seg_in1, &seg_in2
        &seg_out, ierr);

}
```

### 7.18.3 Input parameters *xv\_timesegments\_compute\_or*

Table 55: Input parameters of *xv\_timesegments\_compute\_or*

| C name       | C type                      | Array Element | Description   | Unit (Format) | Allowed Range          |
|--------------|-----------------------------|---------------|---|---------------|------------------------|
| orbit_id     | xo_orbit_id*                | -             | Structure that contains the orbit data  | -             | -                      |
| order_switch | long                        | -             | Indicates if the input list is sorted by start times. If input segments are already sorted, the flag should be set to XV_TIME_ORDER to save computation time. | -             | Complete (see Table 3) |
| seg_in1      | xv_visibility_interval_list | -             | Input list of segments 1  | -             | -                      |
| seg_in2      | xv_visibility_interval_list | -             | Input list of segments 2  | -             | -                      |

## 7.18.4 Output parameters `xv_timesegments_compute_or`

Table 56: Output parameters of `xv_timesegments_compute_or`

| C name                                  | C type                                   | Array Element | Description   | Unit (Format) | Allowed Range |
|---|--|---------------|---|---------------|---------------|
| <code>xv_timesegments_compute_or</code> | long                                     |               | Function status flag,<br>= 0 No error<br>> 0 Warnings, results generated<br>< 0 Error, no results generated |               |               |
| <code>seg_out</code>                    | <code>xv_visibility_interval_list</code> | -             | Output list of segments   | -             | -             |
| <code>ierr[]</code>                     | long                                     |               | Error status flags  |               |               |

**Memory Management:** Note that the memory for the output visibility segments arrays is allocated within the `xv_timesegments_compute_or` function. So the user will only have to declare those pointers but not to allocate memory for them. However, once the function has returned without error, the user will have the responsibility of freeing the memory for those pointers once they are not used.

### 7.18.5 Warnings and errors

Next table lists the possible error messages that can be returned by the `xv_timesegments_compute_or` CFI function after translating the returned status vector into the equivalent list of error messages by calling the function of the EO\_VISIBILITY software library `xv_get_msg`.

This table also indicates the type of message returned, i.e. either a warning (WARN) or an error (ERR), the cause of such a message and the impact on the performed calculation, mainly on the results vector.

The table is completed by the error code and value. These error codes can be obtained translating the status vector returned by the `xv_timesegments_compute_or` CFI function by calling the function of the EO\_VISIBILITY software library `xv_get_code`.

**Table 57: Error messages and codes**

| Error type | Error message   | Cause and impact          | Error Code  | Error No |
|------------|---|---------------------------|---|----------|
| ERR        | Error allocating internal memory.                         | Computation not performed | XV_CFI_TIMESEGMENTS_COMPUTE_OR_MEMORY_ERR           | 0        |
| ERR        | Error getting absolute orbit vector from relative orbits. | Computation not performed | XV_CFI_TIMESEGMENTS_COMPUTE_OR_REL_TO_ABS_ORBIT_ERR | 1        |
| ERR        | Error getting relative orbit vector from absolute orbits. | Computation not performed | XV_CFI_TIMESEGMENTS_COMPUTE_OR_ABS_TO_REL_ORBIT_ERR | 2        |
| ERR        | Error sorting input list.                                 | Computation not performed | XV_CFI_TIMESEGMENTS_COMPUTE_OR_SORTING_ERR          | 3        |
| ERR        | Geostationary satellite not allowed for this function.    | Computation not performed | XV_CFI_TIMESEGMENTS_COMPUTE_OR_GEO_SAT_ERR          | 4        |
| ERR        | Wrong input time type                                     | Computation not performed | XV_CFI_TIMESEGMENTS_COMPUTE_OR_TIME_TYPE_ERR        | 5        |
| ERR        | Error computing time to orbit parameters                  | Computation not performed | XV_CFI_TIMESEGMENTS_COMPUTE_OR_TIME_TO_ORBIT_ERR    | 6        |
| ERR        | Error computing UTC time for orbit                        | Computation not performed | XV_CFI_TIMESEGMENTS_COMPUTE_OR_GET_UTC_TIME_ERR     | 7        |

## 7.19 xv\_time\_segments\_and

### 7.19.1 Overview

**Note:** this function is deprecated. Use `xv_timesegments_compute_and` instead.

An orbital segment is a time interval along the orbit, defined by start and stop times expressed as an orbit number and the seconds elapsed since the ascending node crossing.

The `xv_time_segments_and` function computes the intersection of a list of orbital segments (see Figure 26)

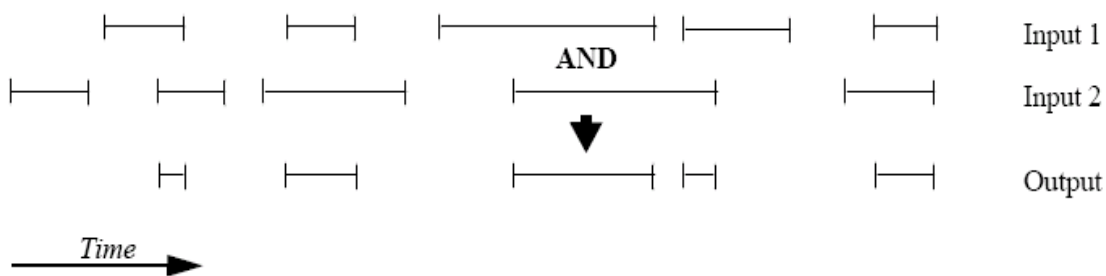

**Figure 26: xv\_time\_segments\_and\_function**

The input segments list need to be sorted according to the start time of the segments. If this list is not sorted, it should be indicated in the function interface with the corresponding parameter (see below). In this case the input list will be modified accordingly.

The time intervals used by `xv_time_segments_and` can be expressed in absolute or relative orbit numbers. This is valid for both:

- input parameter: first and last orbit to be considered. In case of using relative orbits, the corresponding cycle numbers should be used, otherwise, the cycle number will be a dummy parameter.
- output parameter: time segments with time expressed as {absolute orbit number (or relative orbit and cycle number), number of seconds since ANX, number of microseconds}

The orbit representation (absolute or relative) for the output segments will be the same as in the input orbits. Moreover, the segments will be ordered chronologically.

The `xv_time_segments_and` requires access to the following files to produce its results:

- the Orbit Scenario File: only if the orbits are expressed in relative numbers.

## 7.19.2 Calling sequence xv\_time\_segments\_and

For C programs, the call to xv\_time\_segments\_and is (input parameters are underlined):

```
#include "explorer_visibility.h"
{

    xo_orbit_id  orbit_id = {NULL};
    long         orbit_type, order_switch,
                num_segments_1,
                *bgn_orbit_1, *bgn_secs_1,
                *bgn_microsecs_1, *bgn_cycle_1,
                *end_orbit_1, *end_secs_1,
                *end_microsecs_1, *end_cycle_1,
                num_segments_2,
                *bgn_orbit_2, *bgn_secs_2,
                *bgn_microsecs_2, *bgn_cycle_2,
                *end_orbit_2, *end_secs_2,
                *end_microsecs_2, *end_cycle_2,
                num_segments_out,
                *bgn_orbit_out, *bgn_secs_out,
                *bgn_microsecs_out, *bgn_cycle_out,
                *end_orbit_out, *end_secs_out,
                *end_microsecs_out, *end_cycle_out,
                ierr[XV_NUM_ERR_AND], status;

    status = xv_time_segments_and (
        &orbit_id,
        &orbit_type, &order_switch,
        &number_segments_1,
        bgn_orbit_1, bgn_second_1,
        bgn_microsec_1, bgn_cycle_1,
        end_orbit_1, end_second_1,
        end_microsec_1, end_cycle_1,
        &number_segments_2,
        bgn_orbit_2, bgn_second_2,
        bgn_microsec_2, bgn_cycle_2,
        end_orbit_2, end_second_2,
        end_microsec_2, end_cycle_2,
        &num_segments_out,
```

```
&bgn_orbit_out, &bgn_secs_out,  
&bgn_microsecs_out, &bgn_cycle_out,  
&end_orbit_out, &end_secs_out,  
&end_microsecs_out, &end_cycle_out,  
ierr);  
  
/* Or, using the run_id */  
long run_id;  
  
status = xv_time_segments_and_run (  
    &run_id,  
    &orbit_type, &order_switch,  
    &number_segments_1,  
    bgn_orbit_1, bgn_second_1,  
    bgn_microsec_1, bgn_cycle_1,  
    end_orbit_1, end_second_1,  
    end_microsec_1, end_cycle_1,  
    &number_segments_2,  
    bgn_orbit_2, bgn_second_2,  
    bgn_microsec_2, bgn_cycle_2,  
    end_orbit_2, end_second_2,  
    end_microsec_2, end_cycle_2,  
    &num_segments_out,  
    &bgn_orbit_out, &bgn_secs_out,  
    &bgn_microsecs_out, &bgn_cycle_out,  
    &end_orbit_out, &end_secs_out,  
    &end_microsecs_out, &end_cycle_out,  
    ierr);  
  
}
```

### 7.19.3 Input parameters xv\_time\_segments\_and

Table 58: Input parameters of xv\_time\_segments\_and

| C name          | C type       | Array Element | Description   | Unit (Format) | Allowed Range          |
|-----------------|--------------|---------------|---|---------------|------------------------|
| orbit_id        | xo_orbit_id* | -             | Structure that contains the orbit data  | -             | -                      |
| orbit_type      | long         | -             | Define the type of orbit representation, i.e. absolute or relative orbits in the input/output parameters  | -             | Complete (see Table 3) |
| order_switch    | long         | -             | Indicates if the input list is sorted by start times. If input segments are already sorted, the flag should be set to XV_TIME_ORDER to save computation time. | -             | Complete (see Table 3) |
| num_segments_1  | long         | -             | Number of segments in the input list 1.   | -             | >0                     |
| bgn_orbit_1     | long*        | all           | Array of orbit numbers for the beginning of the segments in list 1  | -             | >0                     |
| bgn_secs_1      | long*        | all           | Array of seconds elapsed since ANX for the beginning of the segments in list 1  | -             | >0<br><nodal period    |
| bgn_microsecs_1 | long*        | all           | Array of microseconds within a second for the beginning of the segments in list 1   | -             | >0<br><999999          |
| bgn_cycle_1     | long*        | all           | Array of cycle numbers for the beginning of the segments in list 1. When using absolute orbits, a NULL pointer can be used.                                   | -             | >0 or NULL             |
| end_orbit_1     | long*        | all           | Array of orbit numbers for the end of the segments in list 1  | -             | >0                     |
| end_secs_1      | long*        | all           | Array of seconds elapsed since ANX for the end of the segments in list 1  | -             | >0<br><nodal period    |
| end_microsecs_1 | long*        | all           | Array of microseconds within a second for the end of the segments in list 1   | -             | >0<br><999999          |
| end_cycle_1     | long*        | all           | Array of cycle numbers for the end of the segments in list 1. When using absolute orbits, a NULL pointer can be used.   | -             | >0 or NULL             |
| num_segments_2  | long         | -             | Number of segments in the input list 2.   | -             | >0                     |



|                 |       |     |   |   |                     |
|-----------------|-------|-----|---|---|---------------------|
| bgn_orbit_2     | long* | all | Array of orbit numbers for the beginning of the segments in list 2  | - | >0                  |
| bgn_secs_2      | long* | all | Array of seconds elapsed since ANX for the beginning of the segments in list 2  | - | >0<br><nodal period |
| bgn_microsecs_2 | long* | all | Array of microseconds within a second for the beginning of the segments in list 2   | - | >0<br><999999       |
| bgn_cycle_2     | long* | all | Array of cycle numbers for the beginning of the segments in list 2. When using absolute orbits, a NULL pointer can be used. | - | >0 or NULL          |
| end_orbit_2     | long* | all | Array of orbit numbers for the end of the segments in list 2  | - | >0                  |
| end_secs_2      | long* | all | Array of seconds elapsed since ANX for the end of the segments in list 2  | - | >0<br><nodal period |
| end_microsecs_2 | long* | all | Array of microseconds within a second for the end of the segments in list 2   | - | >0<br><999999       |
| end_cycle_2     | long* | all | Array of cycle numbers for the end of the segments in list 2. When using absolute orbits, a NULL pointer can be used.       | - | >0 or NULL          |

## 7.19.4 Output parameters *xv\_time\_segments\_and*

Table 59: Output parameters of *xv\_time\_segments\_and*

| C name                      | C type | Array Element | Description   | Unit (Format ) | Allowed Range       |
|-----------------------------|--------|---------------|---|----------------|---------------------|
| <i>xv_time_segments_and</i> | long   |               | Function status flag,<br>= 0 No error<br>> 0 Warnings, results generated<br>< 0 Error, no results generated |                |                     |
| <i>num_segments_out</i>     | long   | -             | Number of segments in the output list.  | -              | >0                  |
| <i>bgn_orbit_out</i>        | long*  | all           | Array of orbit numbers for the beginning of the segments  | -              | >0                  |
| <i>bgn_secs_out</i>         | long*  | all           | Array of seconds elapsed since ANX for the beginning of the segments  | -              | >0<br><nodal period |
| <i>bgn_microsecs_out</i>    | long*  | all           | Array of microseconds within a second for the beginning of the segments                                     | -              | >0<br><999999       |
| <i>bgn_cycle_out</i>        | long*  | all           | Array of cycle numbers for the beginning of the segments.   | -              | >0                  |
| <i>end_orbit_out</i>        | long*  | all           | Array of orbit numbers for the end of the segments  | -              | >0                  |
| <i>end_secs_out</i>         | long*  | all           | Array of seconds elapsed since ANX for the end of the segments  | -              | >0<br><nodal period |
| <i>end_microsecs_out</i>    | long*  | all           | Array of microseconds within a second for the end of the segments   | -              | >0<br><999999       |
| <i>end_cycle_out</i>        | long*  | all           | Array of cycle numbers for the end of the segments.   | -              | >0 or NULL          |
| <i>ierr[10]</i>             | long   |               | Error status flags  |                |                     |

**Memory Management:** Note that the output visibility segments arrays are pointers to integers instead of static arrays. The memory for these dynamic arrays is allocated within the *xv\_time\_segments\_and* function. So the user will only have to declare those pointers but not to allocate memory for them. However, once the function has returned without error, the user will have the responsibility of freeing the memory for those pointers once they are not used.

### 7.19.5 Warnings and errors

Next table lists the possible error messages that can be returned by the `xv_time_segments_and` CFI function after translating the returned status vector into the equivalent list of error messages by calling the function of the EO\_VISIBILITY software library `xv_get_msg`.

This table also indicates the type of message returned, i.e. either a warning (WARN) or an error (ERR), the cause of such a message and the impact on the performed calculation, mainly on the results vector.

The table is completed by the error code and value. These error codes can be obtained translating the status vector returned by the `xv_time_segments_and` CFI function by calling the function of the EO\_VISIBILITY software library `xv_get_code`.

**Table 60: Error messages and codes**

| Error type | Error message   | Cause and impact          | Error Code                                    | Error No |
|------------|---|---------------------------|---|----------|
| ERR        | Error allocating internal memory.   | Computation not performed | XV_CFI_TIME_SEGMENTS_AND_MEMORY_ERR           | 0        |
| ERR        | Error getting absolute orbit vector from relative orbits.                 | Computation not performed | XV_CFI_TIME_SEGMENTS_AND_REL_TO_ABS_ORBIT_ERR | 1        |
| ERR        | Error getting relative orbit vector from absolute orbits.                 | Computation not performed | XV_CFI_TIME_SEGMENTS_AND_ABS_TO_REL_ORBIT_ERR | 2        |
| ERR        | Error sorting input list.   | Computation not performed | XV_CFI_TIME_SEGMENTS_AND_SORTING_ERR          | 3        |
| ERR        | Geostationary satellite not allowed for this function.                    | Computation not performed | XV_CFI_TIME_SEGMENTS_AND_GEO_SAT_ERR          | 4        |
| WARN       | Deprecated function. Use <code>xv_timesegments_compute_and</code> instead | Computation performed     | XV_CFI_TIME_SEGMENTS_AND_DEPRECATED_WARN      | 5        |

## 7.20 xv\_timesegments\_compute\_and

### 7.20.1 Overview

An orbital segment is a time interval along the orbit, defined by start and stop times expressed as an orbit number and the seconds elapsed since the ascending node crossing.

The **xv\_timesegments\_compute\_and** function computes the intersection of a list of orbital segments (see Figure 27)

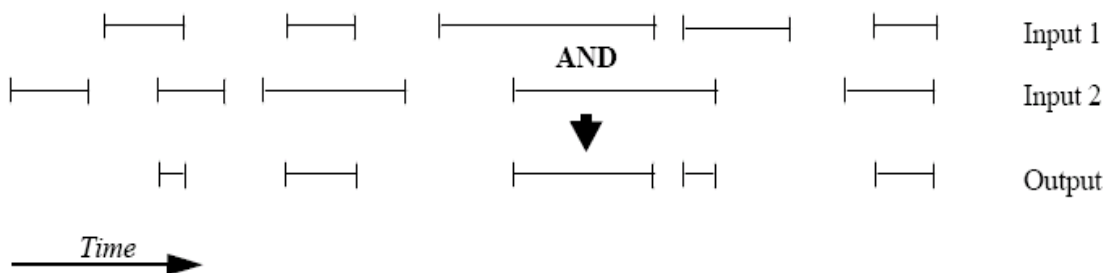

Figure 27: xv\_timesegments\_compute\_and\_function

The input segments list need to be sorted according to the start time of the segments. If this list is not sorted, it should be indicated in the function interface with the corresponding parameter (see below). In this case the input list will be modified accordingly.

The time intervals (*xv\_time\_interval*) used by **xv\_timesegments\_compute\_and** can be expressed as UTC times or orbit times (orbit plus seconds and microseconds since ascending node). This intervals express the start time/orbit and last time/orbit for the computations.

In case the time intervals are expressed as orbits, they can be expressed as absolute orbit numbers or in relative orbit and cycle numbers.

The orbit representation (absolute or relative) for the output segments will be the same as in the input orbits. The output segments will contain UTC times and orbit times. Moreover, the segments will be ordered chronologically.

The **xv\_timesegments\_compute\_and** requires access to the following files to produce its results:

- the Orbit Scenario File: only if the orbits are expressed in relative numbers.

## 7.20.2 Calling sequence *xv\_timesegments\_compute\_and*

For C programs, the call to `xv_timesegments_compute_and` is (input parameters are underlined):

```
#include "explorer_visibility.h"
{

    xo_orbit_id orbit_id = {NULL};
    long    order_switch;
    xv_visibility_interval_list seg_in1, seg_in2;
    xv_visibility_interval_list seg_out;
    long ierr[XV_NUM_ERR_COMPUTE_AND];
    long status;

    status = xv_timesegments_compute_and(
        &orbit_id, &order_switch,
        &seg_in1, &seg_in2,
        &seg_out, ierr);

    /* Or, using the run_id */
    long run_id;

    status = xv_timesegments_compute_and(
        &run_id, &order_switch,
        &seg_in1, &seg_in2,
        &seg_out, ierr);

}
```

### 7.20.3 Input parameters *xv\_timesegments\_compute\_and*

Table 61: Input parameters of *xv\_timesegments\_compute\_and*

| C name       | C type                      | Array Element | Description  | Unit (Format) | Allowed Range          |
|--------------|-----------------------------|---------------|--|---------------|------------------------|
| orbit_id     | xo_orbit_id*                | -             | Structure that contains the orbit data   | -             | -                      |
| order_switch | long                        | -             | Indicates if the input list is sorted by start times. If input segments are already sorted, the flag should be set to <code>XV_TIME_ORDER</code> to save computation time. | -             | Complete (see Table 3) |
| seg_in1      | xv_visibility_interval_list | -             | Input list of segments 1   | -             | -                      |
| seg_in2      | xv_visibility_interval_list | -             | Input list of segments 2   | -             | -                      |

## 7.20.4 Output parameters *xv\_timesegments\_compute\_and*

Table 62: Output parameters of *xv\_timesegments\_compute\_and*

| C name                             | C type                             | Array Element | Description   | Unit (Format ) | Allowed Range |
|------------------------------------|------------------------------------|---------------|---|----------------|---------------|
| <i>xv_timesegments_compute_and</i> | long                               |               | Function status flag,<br>= 0 No error<br>> 0 Warnings, results generated<br>< 0 Error, no results generated |                |               |
| <i>seg_out</i>                     | <i>xv_visibility_interval_list</i> | -             | Output list of segments   | -              | -             |
| <i>ierr[]</i>                      | long                               |               | Error status flags  |                |               |

**Memory Management:** Note that the memory for the output visibility segments arrays is allocated within the *xv\_timesegments\_compute\_and* function. So the user will only have to declare those pointers but not to allocate memory for them. However, once the function has returned without error, the user will have the responsibility of freeing the memory for those pointers once they are not used.

### 7.20.5 Warnings and errors

Next table lists the possible error messages that can be returned by the `xv_timesegments_compute_and` CFI function after translating the returned status vector into the equivalent list of error messages by calling the function of the EO\_VISIBILITY software library `xv_get_msg`.

This table also indicates the type of message returned, i.e. either a warning (WARN) or an error (ERR), the cause of such a message and the impact on the performed calculation, mainly on the results vector.

The table is completed by the error code and value. These error codes can be obtained translating the status vector returned by the `xv_timesegments_compute_and` CFI function by calling the function of the EO\_VISIBILITY software library `xv_get_code`.

**Table 63: Error messages and codes**

| Error type | Error message   | Cause and impact          | Error Code   | Error No |
|------------|---|---------------------------|--|----------|
| ERR        | Error allocating internal memory.                         | Computation not performed | XV_CFI_TIMESEGMENTS_COMPUTE_AND_MEMORY_ERR           | 0        |
| ERR        | Error getting absolute orbit vector from relative orbits. | Computation not performed | XV_CFI_TIMESEGMENTS_COMPUTE_AND_REL_TO_ABS_ORBIT_ERR | 1        |
| ERR        | Error getting relative orbit vector from absolute orbits. | Computation not performed | XV_CFI_TIMESEGMENTS_COMPUTE_AND_ABS_TO_REL_ORBIT_ERR | 2        |
| ERR        | Error sorting input list.                                 | Computation not performed | XV_CFI_TIMESEGMENTS_COMPUTE_AND_SORTING_ERR          | 3        |
| ERR        | Geostationary satellite not allowed for this function.    | Computation not performed | XV_CFI_TIMESEGMENTS_COMPUTE_AND_GEO_SAT_ERR          | 4        |
| ERR        | Wrong input time type                                     | Computation not performed | XV_CFI_TIMESEGMENTS_COMPUTE_AND_TIME_TYPE_ERR        | 5        |
| ERR        | Error computing time to orbit parameters                  | Computation not performed | XV_CFI_TIMESEGMENTS_COMPUTE_AND_TIME_TO_ORBIT_ERR    | 6        |
| ERR        | Error computing UTC time for orbit                        | Computation not performed | XV_CFI_TIMESEGMENTS_COMPUTE_AND_GET_UTC_TIME_ERR     | 7        |



## 7.21 xv\_time\_segments\_sort

### 7.21.1 Overview

**Note:** this function is deprecated. Use `xv_timesegments_compute_sort` instead.

An orbital segment is a time interval along the orbit, defined by start and stop times expressed as an orbit number and the seconds elapsed since the ascending node crossing.

The `xv_time_segments_sort` function sorts a list of orbital segments following two different criteria:

- Absolute orbits: the segments are sorted by their start time
- Relative orbits

The time intervals used by `xv_time_segments_sort` can be expressed in absolute or relative orbit numbers. This is valid for both:

- input parameter: first and last orbit to be considered. In case of using relative orbits, the corresponding cycle numbers should be used, otherwise, the cycle number will be a dummy parameter.
- output parameter: time segments with time expressed as {absolute orbit number (or relative orbit and cycle number), number of seconds since ANX, number of microseconds}

The orbit representation (absolute or relative) for the output segments will be the same as in the input orbits. Note that the sort criteria does not have any relation with the chosen orbit representation. The following example clarifies this:

Input orbits: 6, 8, 4, 5, 9, 3 (absolute)

Let's suppose that the cycle length is 4 orbits. Then the relative orbits are:

input orbits: 2, 4, 4, 1, 1, 3 (relative)

When ordering this array, we have the following possibilities (Table 64) depending on the orbit representation and the sort criteria chosen:

**Table 64: xv\_time\_segments\_sort function**

| Input                               | Sort Criteria   | Output                              |
|-------------------------------------|-----------------|-------------------------------------|
| absolute orbits<br>6, 8, 4, 5, 9, 3 | absolute orbits | absolute orbits<br>3, 4, 5, 6, 8, 9 |
|                                     | relative orbits | absolute orbits<br>5, 9, 6, 3, 4, 8 |
| relative orbits<br>2, 4, 4, 1, 1, 3 | absolute orbits | relative orbits<br>3, 4, 1, 2, 4, 1 |
|                                     | relative orbits | relative orbits<br>1, 1, 2, 3, 4, 4 |

The `xv_time_segments_sort` requires access the following files to produce its results:

- the Orbit Scenario File: only if the orbits are expressed in relative numbers.

## 7.21.2 Calling sequence *xv\_time\_segments\_sort*

For C programs, the call to `xv_time_segments_sort` is (input parameters are underlined):

```
#include "explorer_visibility.h"
{

    xo_orbit_id  orbit_id = {NULL};
    long         orbit_type, sort_criteria,
               num_segments,
               *bgn_orbit, *bgn_secs,
               *bgn_microsecs, *bgn_cycle,
               *end_orbit, *end_secs,
               *end_microsecs, *end_cycle,
               ierr, status;

    status = xv_time_segments_sort (
        &orbit_id,
        &orbit_type, &sort_criteria,
        &number_segments,
        bgn_orbit, bgn_second,
        bgn_microsec, bgn_cycle,
        end_orbit, end_second,
        end_microsec, end_cycle,
        ierr);

    /* Or, using the run_id */
    long run_id;

    status = xv_time_segments_sort_run (
        &run_id,
        &orbit_type, &sort_criteria,
        &number_segments,
        bgn_orbit, bgn_second,
        bgn_microsec, bgn_cycle,
        end_orbit, end_second,
        end_microsec, end_cycle,
        ierr);
}
```

### 7.21.3 Input parameters *xv\_time\_segments\_sort*

Table 65: Input parameters of *xv\_time\_segments\_sort*

| C name        | C type       | Array Element | Description   | Unit (Format) | Allowed Range          |
|---------------|--------------|---------------|---|---------------|------------------------|
| orbit_id      | xo_orbit_id* | -             | Structure that contains the orbit data  | -             | -                      |
| orbit_type    | long         | -             | Define the type of orbit representation, i.e. absolute or relative orbits in the input/output parameters          | -             | Complete (see Table 3) |
| sort_criteria | long         | -             | sorting criteria to be used: absolute or relative orbits  | -             | Complete (see Table 3) |
| num_segments  | long         | -             | Number of segments in the input.  | -             | >0                     |
| bgn_orbit     | long*        | all           | Array of orbit numbers for the beginning of the segments  | -             | >0                     |
| bgn_secs      | long*        | all           | Array of seconds elapsed since ANX for the beginning of the segments  | -             | >0<br><nodal period    |
| bgn_microsecs | long*        | all           | Array of microseconds within a second for the beginning of the segments   | -             | >0<br><999999          |
| bgn_cycle     | long*        | all           | Array of cycle numbers for the beginning of the segments. When using absolute orbits, a NULL pointer can be used. | -             | >0 or NULL             |
| end_orbit     | long*        | all           | Array of orbit numbers for the end of the segments  | -             | >0                     |
| end_secs      | long*        | all           | Array of seconds elapsed since ANX for the end of the segments  | -             | >0<br><nodal period    |
| end_microsecs | long*        | all           | Array of microseconds within a second for the end of the segments.  | -             | >0<br><999999          |
| end_cycle     | long*        | all           | Array of cycle numbers for the end of the segments. When using absolute orbits, a NULL pointer can be used.       | -             | >0 or NULL             |

## 7.21.4 Output parameters *xv\_time\_segments\_sort*

Table 66: Output parameters of *xv\_time\_segments\_sort*

| C name                      | C type | Array Element | Description   | Unit (Format) | Allowed Range |
|-----------------------------|--------|---------------|---|---------------|---------------|
| <i>xv_time_segments_and</i> | long   |               | Function status flag,<br>= 0 No error<br>> 0 Warnings, results generated<br>< 0 Error, no results generated |               |               |
| <i>ierr</i> [10]            | long   |               | Error status flags  |               |               |

### 7.21.5 Warnings and errors

Next table lists the possible error messages that can be returned by the `xv_time_segments_sort` CFI function after translating the returned status vector into the equivalent list of error messages by calling the function of the EO\_VISIBILITY software library `xv_get_msg`.

This table also indicates the type of message returned, i.e. either a warning (WARN) or an error (ERR), the cause of such a message and the impact on the performed calculation, mainly on the results vector.

The table is completed by the error code and value. These error codes can be obtained translating the status vector returned by the `xv_time_segments_sort` CFI function by calling the function of the EO\_VISIBILITY software library `xv_get_code`.

**Table 67: Error messages and codes**

| Error type | Error message  | Cause and impact          | Error Code                                   | Error No |
|------------|--|---------------------------|--|----------|
| ERR        | Error allocating internal memory.  | Computation not performed | XV_CFI_TIME_SEGMENTS_SORT_MEMORY_ERR         | 0        |
| ERR        | Error getting absolute orbit vector from relative orbits.                  | Computation not performed | XV_CFI_TIME_SEGMENTS_SORT_CHANGING_ORBIT_ERR | 1        |
| ERR        | Geostationary satellite not allowed for this function.                     | Computation not performed | XV_CFI_TIME_SEGMENTS_SORT_GEO_SAT_ERR        | 2        |
| WARN       | Deprecated function. Use <code>xv_timesegments_compute_sort</code> instead | Computation performed     | XV_CFI_TIME_SEGMENTS_SORT_DEPRECATED_WARN    | 3        |

## 7.22 xv\_timesegments\_compute\_sort

### 7.22.1 Overview

An orbital segment is a time interval along the orbit, defined by start and stop times expressed as an orbit number and the seconds elapsed since the ascending node crossing.

The **xv\_timesegments\_compute\_sort** function sorts a list of orbital segments following two different criteria:

- Absolute orbits: the segments are sorted by their start time
- Relative orbits

The time intervals (**xv\_time\_interval**) used by **xv\_timesegments\_compute\_and** can be expressed as UTC times or orbit times (orbit plus seconds and microseconds since ascending node). This intervals express the start time/orbit and last time/orbit for the computations.

In case the time intervals are expressed as orbits, they can be expressed as absolute orbit numbers or in relative orbit and cycle numbers.

The orbit representation (absolute or relative) for the output segments will be the same as in the input orbits. The output segments will contain UTC times and orbit times.

Note that the sort criteria does not have any relation with the chosen orbit representation. The following example clarifies this:

Input orbits: 6, 8, 4, 5, 9, 3 (absolute)

Let's suppose that the cycle length is 4 orbits. Then the relative orbits are:

input orbits: 2, 4, 4, 1, 1, 3 (relative)

When ordering this array, we have the following possibilities (Table 68) depending on the orbit representation and the sort criteria chosen:

**Table 68: xv\_timesegments\_compute\_sort function**

| Input                               | Sort Criteria   | Output                              |
|-------------------------------------|-----------------|-------------------------------------|
| absolute orbits<br>6, 8, 4, 5, 9, 3 | absolute orbits | absolute orbits<br>3, 4, 5, 6, 8, 9 |
|                                     | relative orbits | absolute orbits<br>5, 9, 6, 3, 4, 8 |
| relative orbits<br>2, 4, 4, 1, 1, 3 | absolute orbits | relative orbits<br>3, 4, 1, 2, 4, 1 |
|                                     | relative orbits | relative orbits<br>1, 1, 2, 3, 4, 4 |

The **xv\_timesegments\_compute\_sort** requires access the following files to produce its results:

- the Orbit Scenario File: only if the orbits are expressed in relative numbers.

### **7.22.2 Calling sequence `xv_timesegments_compute_sort`**

For C programs, the call to `xv_timesegments_compute_sort` is (input parameters are underlined):

```
#include"explorer_visibility.h"
{

    xo_orbit_id orbit_id = {NULL};
    long      sort_criteria;
    xv_visibility_interval_list seg_in;
    long ierr[XV_NUM_ERR_COMPUTE_SORT];
    long status;

    status = xv_timesegments_compute_sort(
                &orbit_id, &sort_criteria,
                &seg_in, ierr);

    /* Or, using the run_id */
    long run_id;

    status = xv_timesegments_compute_sort(
                &run_id, &sort_criteria,
                &seg_in, ierr);
}
```

### 7.22.3 Input parameters *xv\_timesegments\_compute\_sort*

Table 69: Input parameters of *xv\_timesegments\_compute\_sort*

| C name        | C type                      | Array Element | Description  | Unit (Format) | Allowed Range          |
|---------------|-----------------------------|---------------|--|---------------|------------------------|
| orbit_id      | xo_orbit_id*                | -             | Structure that contains the orbit data                   | -             | -                      |
| sort_criteria | long                        | -             | sorting criteria to be used: absolute or relative orbits | -             | Complete (see Table 3) |
| seg_in        | xv_visibility_interval_list | -             | Input list of segments                                   | -             | -                      |



## 7.22.4 Output parameters *xv\_timesegments\_compute\_sort*

Table 70: Output parameters of *xv\_timesegments\_compute\_sort*

| C name                       | C type | Array Element | Description   | Unit (Format) | Allowed Range |
|------------------------------|--------|---------------|---|---------------|---------------|
| <i>xv_time_segments_sort</i> | long   |               | Function status flag,<br>= 0 No error<br>> 0 Warnings, results generated<br>< 0 Error, no results generated |               |               |
| <i>ierr[]</i>                | long   |               | Error status flags  |               |               |

### 7.22.5 Warnings and errors

Next table lists the possible error messages that can be returned by the `xv_timesegments_compute_sort` CFI function after translating the returned status vector into the equivalent list of error messages by calling the function of the EO\_VISIBILITY software library `xv_get_msg`.

This table also indicates the type of message returned, i.e. either a warning (WARN) or an error (ERR), the cause of such a message and the impact on the performed calculation, mainly on the results vector.

The table is completed by the error code and value. These error codes can be obtained translating the status vector returned by the `xv_timesegments_compute_sort` CFI function by calling the function of the EO\_VISIBILITY software library `xv_get_code`.

**Table 71: Error messages and codes**

| Error type | Error message   | Cause and impact          | Error Code  | Error No |
|------------|---|---------------------------|---|----------|
| ERR        | Error allocating internal memory.                         | Computation not performed | XV_CFI_TIMESEGMENTS_COMPUTE_SORT_MEMORY_ERR         | 0        |
| ERR        | Error getting absolute orbit vector from relative orbits. | Computation not performed | XV_CFI_TIMESEGMENTS_COMPUTE_SORT_CHANGING_ORBIT_ERR | 1        |
| ERR        | Geostationary satellite not allowed for this function.    | Computation not performed | XV_CFI_TIMESEGMENTS_COMPUTE_SORT_GEO_SAT_ERR        | 2        |
| ERR        | Wrong input time type                                     | Computation not performed | XV_CFI_TIMESEGMENTS_COMPUTE_SORT_TIME_TYPE_ERR      | 3        |
| ERR        | Error computing time to orbit parameters                  | Computation not performed | XV_CFI_TIMESEGMENTS_COMPUTE_SORT_TIME_TO_ORBIT_ERR  | 4        |
| ERR        | Error computing UTC time for orbit                        | Computation not performed | XV_CFI_TIMESEGMENTS_COMPUTE_SORT_GET_UTC_TIME_ERR   | 5        |

## 7.23 xv\_time\_segments\_merge

### 7.23.1 Overview

**Note:** this function is deprecated. Use `xv_timesegments_compute_merge` instead.

An orbital segment is a time interval along the orbit, defined by start and stop times expressed as an orbit number and the seconds elapsed since the ascending node crossing.

The `xv_time_segments_merge` function merges all the overlapped segments within a list (see Figure 28)

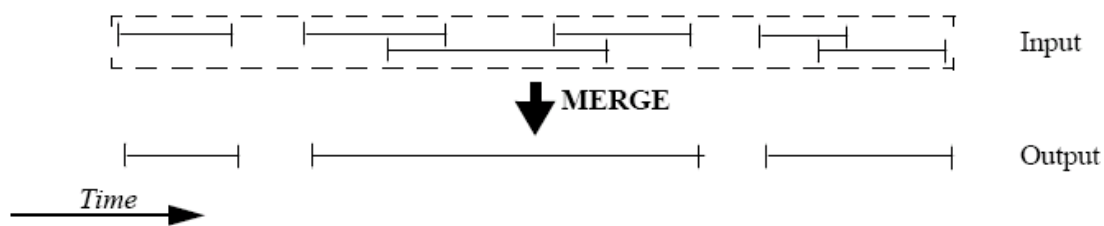

**Figure 28: xv\_time\_segments\_merge function**

The input segments list need to be sorted according to the start time of the segments. If this list is not sorted, it should be indicated in the function interface with the corresponding parameter (see below). In this case the input list will be modified accordingly.

The time intervals used by `xv_time_segments_merge` can be expressed in absolute or relative orbit numbers. This is valid for both:

- input parameter: first and last orbit to be considered. In case of using relative orbits, the corresponding cycle numbers should be used, otherwise, the cycle number will be a dummy parameter.
- output parameter: time segments with time expressed as {absolute orbit number (or relative orbit and cycle number), number of seconds since ANX, number of microseconds}

The orbit representation (absolute or relative) for the output segments will be the same as in the input orbits. Moreover, the segments will be ordered chronologically.

The `xv_time_segments_merge` requires access to the following files to produce its results:

- the Orbit Scenario File: only if the orbits are expressed in relative numbers.

### 7.23.2 Calling sequence `xv_time_segments_merge`

For C programs, the call to `xv_time_segments_merge` is (input parameters are underlined):

```
#include "explorer_visibility.h"
{

    xo_orbit_id  orbit_id = {NULL};
    long        orbit_type, order_switch,
               num_segments,
               *bgn_orbit, *bgn_secs,
               *bgn_microsecs, *bgn_cycle,
               *end_orbit, *end_secs,
               *end_microsecs, *end_cycle,
               num_segments_out,
               *bgn_orbit_out, *bgn_secs_out,
               *bgn_microsecs_out, *bgn_cycle_out,
               *end_orbit_out, *end_secs_out,
               *end_microsecs_out, *end_cycle_out,
               ierr[XV_NUM_ERR_MERGE], status;

    status = xv_time_segments_merge(
        &orbit_id,
        &orbit_type, &order_switch,
        &number_segments,
        bgn_orbit, bgn_secs,
        bgn_microsecs, bgn_cycle,
        end_orbit, end_secs,
        end_microsecs, end_cycle,
        &num_segments_out,
        &bgn_orbit_out, &bgn_secs_out,
        &bgn_microsecs_out, &bgn_cycle_out,
        &end_orbit_out, &end_secs_out,
        &end_microsecs_out, &end_cycle_out,
        ierr);

    /* Or, using the run_id */
    long run_id;

    status = xv_time_segments_merge_run(
```

```
        &run_id,  
        &orbit_type, &order_switch,  
        &number_segments,  
        bgn_orbit, bgn_secs,  
        bgn_microsecs, bgn_cycle,  
        end_orbit, end_secs,  
        end_microsecs, end_cycle,  
        &num_segments_out,  
        &bgn_orbit_out, &bgn_secs_out,  
        &bgn_microsecs_out, &bgn_cycle_out,  
        &end_orbit_out, &end_secs_out,  
        &end_microsecs_out, &end_cycle_out,  
        ierr);  
    }
```

### 7.23.3 Input parameters *xv\_time\_segments\_merge*

Table 72: Input parameters of *xv\_time\_segments\_merge*

| C name          | C type       | Array Element | Description   | Unit (Format) | Allowed Range          |
|-----------------|--------------|---------------|---|---------------|------------------------|
| orbit_id        | xo_orbit_id* | -             | Structure that contains the orbit data  | -             | -                      |
| orbit_type      | long         | -             | Define the type of orbit representation, i.e. absolute or relative orbits in the input/output parameters  | -             | Complete (see Table 3) |
| order_switch    | long         | -             | Indicates if the input list is sorted by start times. If input segments are already sorted, the flag should be set to XV_TIME_ORDER to save computation time. | -             | Complete (see Table 3) |
| num_segments_in | long         | -             | Number of segments in the input list.   | -             | >0                     |
| bgn_orbit       | long*        | all           | Array of orbit numbers for the beginning of the segments  | -             | >0                     |
| bgn_secs        | long*        | all           | Array of seconds elapsed since ANX for the beginning of the segments  | -             | >0<br><nodal period    |
| bgn_microsecs   | long*        | all           | Array of microseconds within a second for the beginning of the segments   | -             | >0<br><999999          |
| bgn_cycle       | long*        | all           | Array of cycle numbers for the beginning of the segments. When using absolute orbits, a NULL pointer can be used.   | -             | >0 or NULL             |
| end_orbit       | long*        | all           | Array of orbit numbers for the end of the segments  | -             | >0                     |
| end_secs        | long*        | all           | Array of seconds elapsed since ANX for the end of the segments  | -             | >0<br><nodal period    |
| end_microsecs   | long*        | all           | Array of microseconds within a second for the end of the segments   | -             | >0<br><999999          |
| end_cycle       | long*        | all           | Array of cycle numbers for the end of the segments. When using absolute orbits, a NULL pointer can be used.   | -             | >0 or NULL             |

### 7.23.4 Output parameters *xv\_time\_segments\_merge*

Table 73: Output parameters of *xv\_time\_segments\_merge*

| C name                        | C type | Array Element | Description   | Unit (Format) | Allowed Range       |
|-------------------------------|--------|---------------|---|---------------|---------------------|
| <i>xv_time_segments_merge</i> | long   |               | Function status flag,<br>= 0 No error<br>> 0 Warnings, results generated<br>< 0 Error, no results generated |               |                     |
| <i>num_segments_out</i>       | long   | -             | Number of segments in the output list.  | -             | >0                  |
| <i>bgn_orbit_out</i>          | long*  | all           | Array of orbit numbers for the beginning of the segments  | -             | >0                  |
| <i>bgn_secs_out</i>           | long*  | all           | Array of seconds elapsed since ANX for the beginning of the segments  | -             | >0<br><nodal period |
| <i>bgn_microsecs_out</i>      | long*  | all           | Array of microseconds within a second for the beginning of the segments                                     | -             | >0<br><999999       |
| <i>bgn_cycle_out</i>          | long*  | all           | Array of cycle numbers for the beginning of the segments.   | -             | >0                  |
| <i>end_orbit_out</i>          | long*  | all           | Array of orbit numbers for the end of the segments  | -             | >0                  |
| <i>end_secs_out</i>           | long*  | all           | Array of seconds elapsed since ANX for the end of the segments  | -             | >0<br><nodal period |
| <i>end_microsecs_out</i>      | long*  | all           | Array of microseconds within a second for the end of the segments   | -             | >0<br><999999       |
| <i>end_cycle_out</i>          | long*  | all           | Array of cycle numbers for the end of the segments.   | -             | >0 or NULL          |
| <i>ierr[10]</i>               | long   |               | Error status flags  |               |                     |

**Memory Management:** Note that the output visibility segments arrays are pointers to integers instead of static arrays. The memory for these dynamic arrays is allocated within the *xv\_time\_segments\_merge* function. So the user will only have to declare those pointers but not to allocate memory for them. However, once the function has returned without error, the user will have the responsibility of freeing the memory for those pointers once they are not used.

### 7.23.5 Warnings and errors

Next table lists the possible error messages that can be returned by the `xv_time_segments_merge` CFI function after translating the returned status vector into the equivalent list of error messages by calling the function of the `EO_VISIBILITY` software library `xv_get_msg`.

This table also indicates the type of message returned, i.e. either a warning (WARN) or an error (ERR), the cause of such a message and the impact on the performed calculation, mainly on the results vector.

The table is completed by the error code and value. These error codes can be obtained translating the status vector returned by the `xv_time_segments_merge` CFI function by calling the function of the `EO_VISIBILITY` software library `xv_get_code`.

**Table 74: Error messages and codes**

| Error type | Error message   | Cause and impact          | Error Code                                      | Error No |
|------------|---|---------------------------|---|----------|
| ERR        | Error allocating internal memory.   | Computation not performed | XV_CFI_TIME_SEGMENTS_MERGE_MEMORY_ERR           | 0        |
| ERR        | Error getting absolute orbit vector from relative orbits.                   | Computation not performed | XV_CFI_TIME_SEGMENTS_MERGE_REL_TO_ABS_ORBIT_ERR | 1        |
| ERR        | Error getting relative orbit vector from absolute orbits.                   | Computation not performed | XV_CFI_TIME_SEGMENTS_MERGE_ABS_TO_REL_ORBIT_ERR | 2        |
| ERR        | Error sorting input list.   | Computation not performed | XV_CFI_TIME_SEGMENTS_MERGE_SORTING_ERR          | 3        |
| ERR        | Geostationary satellite not allowed for this function.                      | Computation not performed | XV_CFI_TIME_SEGMENTS_MERGE_GEO_SAT_ERR          | 4        |
| WARN       | Deprecated function. Use <code>xv_timesegments_compute_merge</code> instead | Computation performed     | XV_CFI_TIME_SEGMENTS_MERGE_DEPRECATED_WARN      | 5        |



## 7.24 xv\_timesegments\_compute\_merge

### 7.24.1 Overview

An orbital segment is a time interval along the orbit, defined by start and stop times expressed as an orbit number and the seconds elapsed since the ascending node crossing.

The `xv_timesegments_compute_merge` function merges all the overlapped segments within a list (see Figure 29)

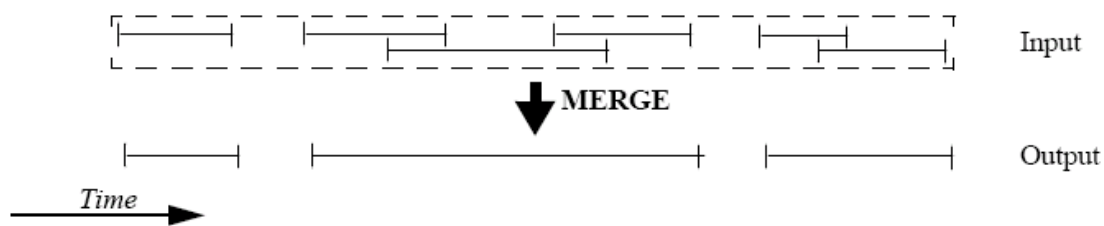

**Figure 29: xv\_timesegments\_compute\_merge function**

The input segments list need to be sorted according to the start time of the segments. If this list is not sorted, it should be indicated in the function interface with the corresponding parameter (see below). In this case the input list will be modified accordingly.

The time intervals (`xv_time_interval`) used by `xv_timesegments_compute_and` can be expressed as UTC times or orbit times (orbit plus seconds and microseconds since ascending node). This intervals express the start time/orbit and last time/orbit for the computations.

In case the time intervals are expressed as orbits, they can be expressed as absolute orbit numbers or in relative orbit and cycle numbers.

The orbit representation (absolute or relative) for the output segments will be the same as in the input orbits. The output segments will contain UTC times and orbit times. Moreover, the segments will be ordered chronologically.

The `xv_timesegments_compute_merge` requires access to the following files to produce its results:

- the Orbit Scenario File: only if the orbits are expressed in relative numbers.

## 7.24.2 Calling sequence `xv_timesegments_compute_merge`

For C programs, the call to `xv_timesegments_compute_merge` is (input parameters are underlined):

```
#include "explorer_visibility.h"
{

    xo_orbit_id orbit_id = {NULL};
    long    order_switch;
    xv_visibility_interval_list seg_in1, seg_in2;
    xv_visibility_interval_list seg_out;
    long ierr[XV_NUM_ERR_COMPUTE_MERGE];
    long status;

    status = xv_timesegments_compute_merge(
        &orbit_id, &order_switch,
        &seg_in,
        &seg_out, ierr);

    /* Or, using the run_id */
    long run_id;

    status = xv_timesegments_compute_merge(
        &run_id, &order_switch,
        &seg_in,
        &seg_out, ierr);
}
```

### 7.24.3 Input parameters *xv\_timesegments\_compute\_merge*

Table 75: Input parameters of *xv\_timesegments\_compute\_merge*

| C name       | C type                      | Array Element | Description   | Unit (Format) | Allowed Range          |
|--------------|-----------------------------|---------------|---|---------------|------------------------|
| orbit_id     | xo_orbit_id*                | -             | Structure that contains the orbit data  | -             | -                      |
| order_switch | long                        | -             | Indicates if the input list is sorted by start times. If input segments are already sorted, the flag should be set to XV_TIME_ORDER to save computation time. | -             | Complete (see Table 3) |
| seg_in       | xv_visibility_interval_list | -             | Input list of segments  | -             | -                      |

## 7.24.4 Output parameters *xv\_timesegments\_compute\_merge*

Table 76: Output parameters of *xv\_timesegments\_compute\_merge*

| C name                               | C type                             | Array Element | Description   | Unit (Format) | Allowed Range |
|--------------------------------------|------------------------------------|---------------|---|---------------|---------------|
| <i>xv_timesegments_compute_merge</i> | long                               |               | Function status flag,<br>= 0 No error<br>> 0 Warnings, results generated<br>< 0 Error, no results generated |               |               |
| <i>seg_out</i>                       | <i>xv_visibility_interval_list</i> | -             | Output list of segments   | -             | -             |
| <i>ierr[]</i>                        | long                               |               | Error status flags  |               |               |

Memory Management: Note that the memory for the output visibility segments arrays is allocated within the *xv\_timesegments\_compute\_merge* function. So the user will only have to declare those pointers but not to allocate memory for them. However, once the function has returned without error, the user will have the responsibility of freeing the memory for those pointers once they are not used.

### 7.24.5 Warnings and errors

Next table lists the possible error messages that can be returned by the `xv_timesegments_compute_merge` CFI function after translating the returned status vector into the equivalent list of error messages by calling the function of the EO\_VISIBILITY software library `xv_get_msg`.

This table also indicates the type of message returned, i.e. either a warning (WARN) or an error (ERR), the cause of such a message and the impact on the performed calculation, mainly on the results vector.

The table is completed by the error code and value. These error codes can be obtained translating the status vector returned by the `xv_timesegments_compute_merge` CFI function by calling the function of the EO\_VISIBILITY software library `xv_get_code`.

**Table 77: Error messages and codes**

| Error type | Error message   | Cause and impact          | Error Code   | Error No |
|------------|---|---------------------------|--|----------|
| ERR        | Error allocating internal memory.                         | Computation not performed | XV_CFI_TIMESEGMENTS_COMPUTE_MERGE_MEMORY_ERR           | 0        |
| ERR        | Error getting absolute orbit vector from relative orbits. | Computation not performed | XV_CFI_TIMESEGMENTS_COMPUTE_MERGE_REL_TO_ABS_ORBIT_ERR | 1        |
| ERR        | Error getting relative orbit vector from absolute orbits. | Computation not performed | XV_CFI_TIMESEGMENTS_COMPUTE_MERGE_ABS_TO_REL_ORBIT_ERR | 2        |
| ERR        | Error sorting input list.                                 | Computation not performed | XV_CFI_TIMESEGMENTS_COMPUTE_MERGE_SORTING_ERR          | 3        |
| ERR        | Geostationary satellite not allowed for this function.    | Computation not performed | XV_CFI_TIMESEGMENTS_COMPUTE_MERGE_GEO_SAT_ERR          | 4        |
| ERR        | Wrong input time type                                     | Computation not performed | XV_CFI_TIMESEGMENTS_COMPUTE_MERGE_TIME_TYPE_ERR        | 5        |
| ERR        | Error computing time to orbit parameters                  | Computation not performed | XV_CFI_TIMESEGMENTS_COMPUTE_MERGE_TIME_TO_ORBIT_ERR    | 6        |
| ERR        | Error computing UTC time for orbit                        | Computation not performed | XV_CFI_TIMESEGMENTS_COMPUTE_MERGE_GET.UTC_TIME_ERR     | 7        |

## 7.25 **xv\_time\_segments\_delta**

### 7.25.1 **Overview**

**Note:** this function is deprecated. Use **xv\_timesegments\_compute\_delta** instead.

An orbital segment is a time interval along the orbit, defined by start and stop times expressed as an orbit number and the seconds elapsed since the ascending node crossing.

The **xv\_time\_segments\_delta** function makes all the segments within a list, longer or shorter. After increasing/decreasing the longitude of the segments, these are sorted and merged to avoid possible overlapping. Therefore, at the end the list is sorted and without overlapped segments.

The time intervals used by **xv\_time\_segments\_delta** can be expressed in absolute or relative orbit numbers. This is valid for both:

- input parameter: first and last orbit to be considered. In case of using relative orbits, the corresponding cycle numbers should be used, otherwise, the cycle number will be a dummy parameter.
- output parameter: time segments with time expressed as {absolute orbit number (or relative orbit and cycle number), number of seconds since ANX, number of microseconds}

The orbit representation (absolute or relative) for the output segments will be the same as in the input orbits.

The **xv\_time\_segments\_delta** requires access to the following files to produce its results:

- the Orbit Scenario File: only if the orbits are expressed in relative numbers.

## 7.25.2 Calling sequence *xv\_time\_segments\_delta*

For C programs, the call to `xv_time_segments_delta` is (input parameters are underlined):

```
#include "explorer_visibility.h"
{
    xo_orbit_id  orbit_id = {NULL};
    long        orbit_type,
               num_segments,
               *bgn_orbit, *bgn_secs,
               *bgn_microsecs, *bgn_cycle,
               *end_orbit, *end_secs,
               *end_microsecs, *end_cycle,
               num_segments_out,
               *bgn_orbit_out, *bgn_secs_out,
               *bgn_microsecs_out, *bgn_cycle_out,
               *end_orbit_out, *end_secs_out,
               *end_microsecs_out, *end_cycle_out,
               ierr[XV_NUM_ERR_DELTA], status;
    double      entry_offset, exit_offset;

    status = xv_time_segments_delta(
        &orbit_id,
        &orbit_type,
        &entry_offset, &exit_offset,
        &number_segments,
        bgn_orbit, bgn_secs,
        bgn_microsecs, bgn_cycle,
        end_orbit, end_secs,
        end_microsecs, end_cycle,
        &num_segments_out,
        &bgn_orbit_out, &bgn_secs_out,
        &bgn_microsecs_out, &bgn_cycle_out,
        &end_orbit_out, &end_secs_out,
        &end_microsecs_out, &end_cycle_out,
        ierr);

    /* Or, using the run_id */
    long run_id;
```

```
status = xv_time_segments_delta_run(  
    &run_id,  
    &orbit_type,  
    &entry_offset, &exit_offset,  
    &number_segments,  
    bgn_orbit, bgn_secs,  
    bgn_microsecs, bgn_cycle,  
    end_orbit, end_secs,  
    end_microsecs, end_cycle,  
    &num_segments_out,  
    &bgn_orbit_out, &bgn_secs_out,  
    &bgn_microsecs_out, &bgn_cycle_out,  
    &end_orbit_out, &end_secs_out,  
    &end_microsecs_out, &end_cycle_out,  
    ierr);  
  
}
```



### 7.25.3 Input parameters *xv\_time\_segments\_delta*

Table 78: Input parameters of *xv\_time\_segments\_delta*

| C name          | C type       | Array Element | Description  | Unit (Format) | Allowed Range          |
|-----------------|--------------|---------------|--|---------------|------------------------|
| orbit_id        | xo_orbit_id* | -             | Structure that contains the orbit data   | -             | -                      |
| orbit_type      | long         | -             | Define the type of orbit representation, i.e. absolute or relative orbits in the input/output parameters   | -             | Complete (see Table 3) |
| entry_offset    | double       |               | Number of seconds to add/ subtract at the beginning of every segments.<br>If entry_offset > 0, the entry_offset is added at the beginning of the segments making them shorter. | seconds       | -                      |
| exit_offset     | double       |               | Number of seconds to add/ subtract at the end of every segments.<br>If exit_offset > 0 the exit_offset is added at the end of the segments making them longer.                 | seconds       | -                      |
| num_segments_in | long         | -             | Number of segments in the input list.  | -             | >0                     |
| bgn_orbit       | long*        | all           | Array of orbit numbers for the beginning of the segments   | -             | >0                     |
| bgn_secs        | long*        | all           | Array of seconds elapsed since ANX for the beginning of the segments   | -             | >0<br><nodal period    |
| bgn_microsecs   | long*        | all           | Array of microseconds within a second for the beginning of the segments  | -             | >0<br><999999          |
| bgn_cycle       | long*        | all           | Array of cycle numbers for the beginning of the segments. When using absolute orbits, a NULL pointer can be used.  | -             | >0 or NULL             |
| end_orbit       | long*        | all           | Array of orbit numbers for the end of the segments   | -             | >0                     |
| end_secs        | long*        | all           | Array of seconds elapsed since ANX for the end of the segments   | -             | >0<br><nodal period    |
| end_microsecs   | long*        | all           | Array of microseconds within a second for the end of the segments  | -             | >0<br><999999          |
| end_cycle       | long*        | all           | Array of cycle numbers for the end of the segments. When using absolute orbits, a NULL pointer can be used.  | -             | >0 or NULL             |

## 7.25.4 Output parameters *xv\_time\_segments\_delta*

Table 79: Output parameters of *xv\_time\_segments\_delta*

| C name                        | C type | Array Element | Description   | Unit (Format) | Allowed Range       |
|-------------------------------|--------|---------------|---|---------------|---------------------|
| <i>xv_time_segments_delta</i> | long   |               | Function status flag,<br>= 0 No error<br>> 0 Warnings, results generated<br>< 0 Error, no results generated |               |                     |
| <i>num_segments_out</i>       | long   | -             | Number of segments in the output list.  | -             | >0                  |
| <i>bgn_orbit_out</i>          | long*  | all           | Array of orbit numbers for the beginning of the segments  | -             | >0                  |
| <i>bgn_secs_out</i>           | long*  | all           | Array of seconds elapsed since ANX for the beginning of the segments  | -             | >0<br><nodal period |
| <i>bgn_microsecs_out</i>      | long*  | all           | Array of microseconds within a second for the beginning of the segments                                     | -             | >0<br><999999       |
| <i>bgn_cycle_out</i>          | long*  | all           | Array of cycle numbers for the beginning of the segments.   | -             | >0                  |
| <i>end_orbit_out</i>          | long*  | all           | Array of orbit numbers for the end of the segments  | -             | >0                  |
| <i>end_secs_out</i>           | long*  | all           | Array of seconds elapsed since ANX for the end of the segments  | -             | >0<br><nodal period |
| <i>end_microsecs_out</i>      | long*  | all           | Array of microseconds within a second for the end of the segments   | -             | >0<br><999999       |
| <i>end_cycle_out</i>          | long*  | all           | Array of cycle numbers for the end of the segments.   | -             | >0 or NULL          |
| <i>ierr[10]</i>               | long   |               | Error status flags  |               |                     |

**Memory Management:** Note that the output visibility segments arrays are pointers to integers instead of static arrays. The memory for these dynamic arrays is allocated within the *xv\_time\_segments\_delta* function. So the user will only have to declare those pointers but not to allocate memory for them. However, once the function has returned without error, the user will have the responsibility of freeing the memory for those pointers once they are not used.

### 7.25.5 Warnings and errors

Next table lists the possible error messages that can be returned by the `xv_time_segments_delta` CFI function after translating the returned status vector into the equivalent list of error messages by calling the function of the `EO_VISIBILITY` software library `xv_get_msg`.

This table also indicates the type of message returned, i.e. either a warning (WARN) or an error (ERR), the cause of such a message and the impact on the performed calculation, mainly on the results vector.

The table is completed by the error code and value. These error codes can be obtained translating the status vector returned by the `xv_time_segments_delta` CFI function by calling the function of the `EO_VISIBILITY` software library `xv_get_code`.

**Table 80: Error messages and codes**

| Error type | Error message   | Cause and impact          | Error Code                                   | Error No |
|------------|---|---------------------------|--|----------|
| ERR        | Error allocating internal memory  | Computation not performed | XV_CFI_TIME_SEGMENTS_DELTA_MEMORY_ERR        | 0        |
| ERR        | Error getting absolute orbit vector from relative orbits                    | Computation not performed | XV_CFI_TIME_SEGMENTS_DELTA_REL_TO_ABS_ERR    | 1        |
| ERR        | Error getting relative orbit vector from absolute orbits                    | Computation not performed | XV_CFI_TIME_SEGMENTS_DELTA_ABS_TO_REL_ERR    | 2        |
| ERR        | Error transforming from orbits to processing times.                         | Computation not performed | XV_CFI_TIME_SEGMENTS_DELTA_ORBIT_TO_TIME_ERR | 3        |
| ERR        | Error transforming from processing times to orbits.                         | Computation not performed | XV_CFI_TIME_SEGMENTS_DELTA_TIME_TO_ORBIT_ERR | 4        |
| ERR        | Error modifying time segment duration                                       | Computation not performed | XV_CFI_TIME_SEGMENTS_DELTA_TIME_ADD_ERR      | 5        |
| ERR        | Error sorting input list  | Computation not performed | XV_CFI_TIME_SEGMENTS_DELTA_SORT_ERR          | 6        |
| ERR        | Geostationary satellite not allowed for this function.                      | Computation not performed | XV_CFI_TIME_SEGMENTS_DELTA_GEO_SAT_ERR       | 7        |
| WARN       | Deprecated function. Use <code>xv_timesegments_compute_delta</code> instead | Computation performed     | XV_CFI_TIME_SEGMENTS_DELTA_DEPRECATED_WARN   | 8        |

## 7.26 xv\_timesegments\_compute\_delta

### 7.26.1 Overview

An orbital segment is a time interval along the orbit, defined by start and stop times expressed as an orbit number and the seconds elapsed since the ascending node crossing.

The **xv\_timesegments\_compute\_delta** function makes all the segments within a list, longer or shorter. After increasing/decreasing the longitude of the segments, these are sorted and merged to avoid possible overlapping. Therefore, at the end the list is sorted and without overlapped segments.

The time intervals (**xv\_time\_interval**) used by **xv\_timesegments\_compute\_and** can be expressed as UTC times or orbit times (orbit plus seconds and microseconds since ascending node). This intervals express the start time/orbit and last time/orbit for the computations.

In case the time intervals are expressed as orbits, they can be expressed as absolute orbit numbers or in relative orbit and cycle numbers.

The orbit representation (absolute or relative) for the output segments will be the same as in the input orbits. The output segments will contain UTC times and orbit times.

The **xv\_timesegments\_compute\_delta** requires access to the following files to produce its results:

- the Orbit Scenario File: only if the orbits are expressed in relative numbers.

## 7.26.2 Calling sequence `xv_timesegments_compute_delta`

For C programs, the call to `xv_timesegments_compute_delta` is (input parameters are underlined):

```
#include "explorer_visibility.h"
{
    xo_orbit_id orbit_id = {NULL};
    xv_visibility_interval_list seg_in;
    xv_visibility_interval_list seg_out;
    long ierr[XV_NUM_ERR_COMPUTE_DELTA];
    long status;
    double entry_offset, exit_offset;

    status = xv_timesegments_compute_delta(
        &orbit_id, &entry_offset, &exit_offset,
        &seg_in,
        &seg_out, ierr);

    /* Or, using the run_id */
    long run_id;

    status = xv_timesegments_compute_delta(
        &run_id, &entry_offset, &exit_offset,
        &seg_in,
        &seg_out, ierr);
}
```

### 7.26.3 Input parameters *xv\_timesegments\_compute\_delta*

Table 81: Input parameters of *xv\_timesegments\_compute\_delta*

| C name       | C type                      | Array Element | Description  | Unit (Format) | Allowed Range |
|--------------|-----------------------------|---------------|--|---------------|---------------|
| orbit_id     | xo_orbit_id*                | -             | Structure that contains the orbit data   | -             | -             |
| entry_offset | double                      |               | Number of seconds to add/ subtract at the beginning of every segments.<br>If entry_offset > 0, the entry_offset is added at the beginning of the segments making them shorter. | seconds       | -             |
| exit_offset  | double                      |               | Number of seconds to add/ subtract at the end of every segments.<br>If exit_offset > 0 the exit_offset is added at the end of the segments making them longer.                 | seconds       | -             |
| seg_in       | xv_visibility_interval_list | -             | Input list of segments   | -             | -             |

### 7.26.4 Output parameters *xv\_timesegments\_compute\_delta*

Table 82: Output parameters of *xv\_timesegments\_compute\_delta*

| C name                 | C type                      | Array Element | Description   | Unit (Format) | Allowed Range |
|------------------------|-----------------------------|---------------|---|---------------|---------------|
| xv_time_segments_delta | long                        |               | Function status flag,<br>= 0 No error<br>> 0 Warnings, results generated<br>< 0 Error, no results generated |               |               |
| seg_out                | xv_visibility_interval_list | -             | Output list of segments   | -             | -             |
| ierr[]                 | long                        |               | Error status flags  |               |               |

**Memory Management:** Note that the memory for the output visibility segments arrays is allocated within the *xv\_timesegments\_compute\_delta* function. So the user will only have to declare those pointers but not to allocate memory for them. However, once the function has returned without error, the user will have the responsibility of freeing the memory for those pointers once they are not used.

### 7.26.5 Warnings and errors

Next table lists the possible error messages that can be returned by the `xv_timesegments_compute_delta` CFI function after translating the returned status vector into the equivalent list of error messages by calling the function of the EO\_VISIBILITY software library `xv_get_msg`.

This table also indicates the type of message returned, i.e. either a warning (WARN) or an error (ERR), the cause of such a message and the impact on the performed calculation, mainly on the results vector.

The table is completed by the error code and value. These error codes can be obtained translating the status vector returned by the `xv_timesegments_compute_delta` CFI function by calling the function of the EO\_VISIBILITY software library `xv_get_code`.

**Table 83: Error messages and codes**

| Error type | Error message  | Cause and impact          | Error Code  | Error No |
|------------|--|---------------------------|---|----------|
| ERR        | Error allocating internal memory                         | Computation not performed | XV_CFI_TIMESEGMENTS_COMPUTE_DELTA_MEMORY_ERR        | 0        |
| ERR        | Error getting absolute orbit vector from relative orbits | Computation not performed | XV_CFI_TIMESEGMENTS_COMPUTE_DELTA_REL_TO_ABS_ERR    | 1        |
| ERR        | Error getting relative orbit vector from absolute orbits | Computation not performed | XV_CFI_TIMESEGMENTS_COMPUTE_DELTA_ABS_TO_REL_ERR    | 2        |
| ERR        | Error transforming from orbits to processing times.      | Computation not performed | XV_CFI_TIMESEGMENTS_COMPUTE_DELTA_ORBIT_TO_TIME_ERR | 3        |
| ERR        | Error transforming from processing times to orbits.      | Computation not performed | XV_CFI_TIMESEGMENTS_COMPUTE_DELTA_TIME_TO_ORBIT_ERR | 4        |
| ERR        | Error modifying time segment duration                    | Computation not performed | XV_CFI_TIMESEGMENTS_COMPUTE_DELTA_TIME_ADD_ERR      | 5        |
| ERR        | Error sorting input list                                 | Computation not performed | XV_CFI_TIMESEGMENTS_COMPUTE_DELTA_SORT_ERR          | 6        |
| ERR        | Geostationary satellite not allowed for this function.   | Computation not performed | XV_CFI_TIMESEGMENTS_COMPUTE_DELTA_GEO_SAT_ERR       | 7        |
| ERR        | Wrong input time type                                    | Computation not performed | XV_TIMESEGMENTS_COMPUTE_DELTA_TIME_TYPE_ERR         | 8        |
| ERR        | Error computing UTC time for orbit                       | Computation not performed | XV_TIMESEGMENTS_COMPUTE_DELTA_GET_UTC_T             | 9        |

---

|  |  |  |         |  |
|--|--|--|---------|--|
|  |  |  | IME_ERR |  |
|--|--|--|---------|--|



## 7.27 xv\_time\_segments\_mapping

### 7.27.1 Overview

**Note:** this function is deprecated. Use `xv_timesegments_compute_mapping` instead.

The function `xv_time_segments_mapping` returns groups of visibility segments of a zone within an orbit range introduced by the user. These groups, or mappings, contain a minimum number of time segments needed to cover the zone completely, and fulfil the following conditions:

- Each mapping only contains ascending or descending segments.
- The segments are ordered by the track number.
- Mappings with one segment will be returned if it covers completely the zone.
- A mapping is searched for each track with segments that only contains left/right coverage in the case of ascending/descending segments, and finishes with a track that only contains right/left coverage.
- Incomplete mappings are not returned. This could happen if the number of orbits is insufficient to cover the zone.

Note that different mappings could contain a subset of segments in common. For example in Figure 30 there are two possible different mappings:

- mapping 1: orbits 1, 2, 3, 4.
- mapping 2: orbits 502, 2, 3, 4.

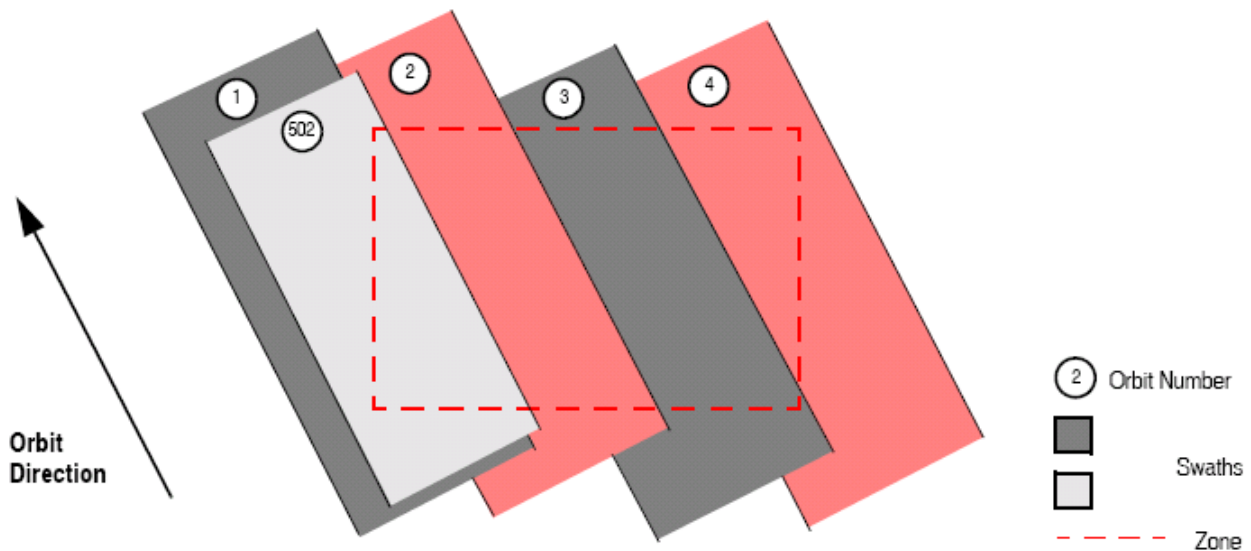

**Figure 30: Different mappings with common segments**

The time intervals used by `xv_time_segments_mapping` can be expressed in absolute or relative orbit numbers. This is valid for both:

- input parameter: first and last orbit to be considered. In case of using relative orbits, the corresponding cycle numbers should be used, otherwise, the cycle number will be a dummy parameter.

- output parameter: time segments with time expressed as {absolute orbit number (or relative orbit and cycle number), number of seconds since ANX, number of microseconds}

The orbit representation (absolute or relative) for the output segments will be the same as in the input orbits.

The **xv\_time\_segments\_mapping** requires access to several data structures and files to produce its results:

- the orbit\_id (xo\_orbit\_id) providing the orbital data. The orbit\_id can be initialized with the following data or files (see [ORBIT\_SUM]):
  - data for an orbital change
  - Orbit scenario files
  - Predicted orbit files
  - Orbit Event Files (**Note: Orbit Event File is deprecated, only supported for CRYOSAT mission**)
  - Restituted orbit files
  - DORIS Preliminary orbit files
  - DORIS Navigator files
- the Instrument Swath File, excluding inertial swath files, describing the area seen by the relevant instrument all along the current orbit. The Swath data can be provided by:
  - A swath template file produced off-line by the EO\_VISIBILITY library (**xv\_gen\_swath** function).
  - A swath definition file, describing the swath geometry. In this case the **xv\_time\_segments\_mapping** generates the swath points for a number of orbits given by the user.
- Zone Database File: just in case of using a zone from the data base.

## 7.27.2 Calling sequence `xv_time_segments_mapping`

For C programs, the call to `xv_time_segments_mapping` is (input parameters are underlined):

```
#include "explorer_visibility.h"
{
    xo_orbit_id  orbit_id = {NULL};
    long        swath_flag, orbit_type,
               start_orbit, start_cycle,
               stop_orbit, stop_cycle,
               zone_num, projection;
    num_mappings, *num_segments,
    *orbit_direction,
    **bgn_orbit, **bgn_secs,
    **bgn_microsec, **bgn_cycle,
    **end_orbit, **end_secs,
    **end_microsec, **end_cycle,
    **coverage,
    ierr[XV_NUM_ERR_MAPPING], status;

    double     zone_diam, *zone_long, *zone_lat;

    char       *swath_file,
               zone_id[9], *zone_db_file;

    status = xv_time_segments_mapping(
        &orbit_id, &orbit_type,
        &start_orbit, &start_cycle,
        &stop_orbit, &stop_cycle,
        &swath_flag, swath_file,
        &zone_num, zone_id, zone_db_file,
        &projection, &zone_diam, zone_long, zone_lat,
        &num_mappings, &num_segments,
        &orbit_direction,
        &bgn_orbit, &bgn_secs, &bgn_microsec, &bgn_cycle,
        &end_orbit, &end_secs, &end_microsec, &end_cycle,
        &coverage, ierr);

    /* Or, using the run_id */
    long run_id;
```

```
status = xv_time_segments_mapping_run(  
    &run_id, &orbit_type,  
    &start_orbit, &start_cycle,  
    &stop_orbit, &stop_cycle,  
    &swath_flag, swath_file,  
    &zone_num, zone_id, zone_db_file,  
    &projection, &zone_diam, zone_long, zone_lat,  
    &num_mappings,          &num_segments,  
    &orbit_direction,  
    &bgn_orbit, &bgn_secs, &bgn_microsec, &bgn_cycle,  
    &end_orbit, &end_secs, &end_microsec, &end_cycle,  
    &coverage, ierr);  
}
```

### 7.27.3 Input parameters *xv\_time\_segments\_mapping*

Table 84: Input parameters of *xv\_time\_segments\_mapping*

| C name      | C type       | Array Element | Description   | Unit (Format)                     | Allowed Range   |
|-------------|--------------|---------------|---|-----------------------------------|---|
| orbit_id    | xo_orbit_id* | -             | Structure that contains the orbit data  | -                                 | -   |
| orbit_type  | long         | -             | Define the type of orbit representation, i.e. absolute or relative orbits in the input/output parameters  | -                                 | Complete (see Table 3)  |
| start_orbit | long         | -             | First orbit, segment filter<br><br>Segments will be filtered as from the beginning of first orbit (within orbit range from orbit_scenario_file)<br><br>First Orbit in the orbit_scenario_file will be used when: <ul style="list-style-type: none"> <li>Absolute orbit is set to zero.</li> <li>Relative orbit and cycle number set to zero.</li> </ul>   | absolute or relative orbit number | = 0<br>or:<br><ul style="list-style-type: none"> <li>absolute orbits <math>\geq</math> start_osf</li> <li>relative orbits <math>\leq</math> repeat cycle</li> </ul> |
| start_cycle | long         | -             | Cycle number corresponding to the start_orbit. Dummy when using relative orbits   | cycle number                      | = 0 or $\geq$ first cycle in osf  |
| stop_orbit  | long         | -             | Last orbit, segment filter.<br><br>The final orbit range defined by the start_orbit (start_cycle) and the stop_orbit (stop_cycle) should not exceed one cycle. Otherwise within one mapping there will appear all the orbits that are equal but that belong to different cycles.<br><br>When: <ul style="list-style-type: none"> <li>stop_orbit = 0 (for orbit_type = XV_ORBIT_ABS)</li> <li>stop_orbit = 0 and stop_cycle = 0 (for orbit_type = XV_ORBIT_REL)</li> </ul> the stop_orbit will be set to the minimum value between: <ul style="list-style-type: none"> <li>the last orbit within the orbital change of the start_orbit.</li> <li>start_orbit+cycle_length-1 (i.e.</li> </ul> | absolute or relative orbit number | = 0<br>or:<br><ul style="list-style-type: none"> <li>absolute orbits <math>\geq</math> start_osf</li> <li>relative orbits <math>\leq</math> repeat cycle</li> </ul> |

|              |         |     |   |              |                                 |
|--------------|---------|-----|---|--------------|---------------------------------|
|              |         |     | the input orbit range will be a complete cycle)   |              |                                 |
| stop_cycle   | long    | -   | Cycle number corresponding to the stop_orbit. Dummy when using relative orbits  | cycle number | = 0 or<br>≥ first cycle in osf  |
| swath_flag   | long*   | -   | Define the use of the swath file: <ul style="list-style-type: none"> <li>• 0 = (XV_STF) if the swath file is a swath template file.</li> <li>• &gt; 0 if the swath files is a swath definition file. In this case the swath points are generated for every "swath_flag" orbits</li> </ul> | -            | XV_STF = 0<br>XV_SDF = 1<br>> 0 |
| swath_file   | char *  | -   | File name of the swath-file for the appropriate instrument mode   |              |                                 |
| zone_num     | long    |     | Number of vertices of the zone provided in zone_long, zone_lat:<br>= 0 no vertices provided, use zone_id / zone_db_file<br>= 1 Point / Circular zone,<br>= 2 Line zone<br>> 2 Polygon zone  |              | ≥ 0                             |
| zone_id[9]   | char    |     | Identification of the zone, as defined in zone_db_file.<br><br>This parameter is used ONLY IF zone_num = 0  |              | EXACTLY 8 characters            |
| zone_db_file | char *  |     | File name of the zone-database- file.<br><br>This file is used ONLY IF zone_num = 0   |              |                                 |
| projection   | long    |     | projection used to define polygon sides as straight lines:<br>= 0 Read projection from Zones DB (rectangular projection is used by default if the DB does not contain a projection)<br>= 1 Azimuthal gnomonic<br>= 2 Rectangular lat/long   |              |                                 |
| zone_diam    | double  |     | Zone diameter for circular zones, dummy for other zones<br><br>If diameter equals 0.0 then zone is Point Zone   | m            | ≥ 0.0                           |
| zone_long    | double* | all | zone_long[i-1]<br><br>Geocentric longitude of   |              |                                 |

|          |         |     |   |  |  |
|----------|---------|-----|---|--|--|
|          |         |     | <ul style="list-style-type: none"> <li>- circle centre, for circ. zone, i =1</li> <li>- point, for point zone, i = 1</li> <li>- line-end, for line zone, i = 1 or 2</li> <li>- vertices, for polygon zone,<br/>i = 1... zone_num</li> </ul>                                       |  |  |
| zone_lat | double* | all | zone_lat[i-1]<br>Geodetic latitude of <ul style="list-style-type: none"> <li>- circle centre, for circ. zone, i =1</li> <li>- point, for point zone, i = 1</li> <li>- line-end, for line zone, i = 1 or 2</li> <li>- vertices, for polygon zone,<br/>i = 1... zone_num</li> </ul> |  |  |

## 7.27.4 Output parameters *xv\_time\_segments\_mapping*

Table 85: Output parameters of *xv\_time\_segments\_mapping*

| C name                          | C type | Array Element | Description   | Unit (Format) | Allowed Range                             |
|---------------------------------|--------|---------------|---|---------------|---|
| <i>xv_time_segments_mapping</i> | long   |               | Function status flag,<br>= 0 No error<br>> 0 Warnings, results generated<br>< 0 Error, no results generated |               |   |
| <i>num_mappings</i>             | long   |               | Number of output mappings   |               | ≥ 0                                       |
| <i>num_segments</i>             | long*  | all           | <i>num_segments[n]</i> = number of segments for the n-th mapping.<br>n=0... ( <i>num_mappings</i> -1)       | -             | > 0                                       |
| <i>orbit_direction</i>          | long*  | all           | Direction of the segments of a mapping.   | -             | Complete (see Table 3: segment direction) |
| <i>bgn_orbit</i>                | long** | all           | Array of orbit numbers for the beginning of the segments  | -             | >0  |
| <i>bgn_secs</i>                 | long** | all           | Array of seconds elapsed since ANX for the beginning of the segments  | -             | >0<br><nodal period                       |
| <i>bgn_microsecs</i>            | long** | all           | Array of microseconds within a second for the beginning of the segments                                     | -             | >0<br><999999                             |
| <i>bgn_cycle</i>                | long** | all           | Array of cycle numbers for the beginning of the segments.   | -             | >0  |
| <i>end_orbit</i>                | long** | all           | Array of orbit numbers for the end of the segments  | -             | >0  |
| <i>end_secs</i>                 | long** | all           | Array of seconds elapsed since ANX for the end of the segments  | -             | >0<br><nodal period                       |
| <i>end_microsecs</i>            | long** | all           | Array of microseconds within a second for the end of the segments   | -             | >0<br><999999                             |
| <i>end_cycle</i>                | long** | all           | Array of cycle numbers for the end of the segments.   | -             | >0 or NULL                                |
| <i>coverage</i>                 | long** | all           | coverage of the output segments.  | -             | complete<br>see Table 3                   |
| <i>ierr</i>                     | long*  |               | Error status flags  |               |   |



---

Note 1: The output visibility segments and the coverage are returned as a two-dimensional table where the first index indicates the number of the mapping, and the second one is the number of the segment within the mapping.

Note 2(Memory Management): Note that the output visibility segments arrays are pointers to integers instead of static arrays. The memory for these dynamic arrays is allocated within the **xv\_time\_segments\_mapping** function. So the user will only have to declare those pointers but not to allocate memory for them. However, once the function has returned without error, the user will have the responsibility of freeing the memory for those pointers once they are not used.

### 7.27.5 Warnings and errors

Next table lists the possible error messages that can be returned by the `xv_time_segments_mapping` CFI function after translating the returned status vector into the equivalent list of error messages by calling the function of the EO\_VISIBILITY software library `xv_get_msg`.

This table also indicates the type of message returned, i.e. either a warning (WARN) or an error (ERR), the cause of such a message and the impact on the performed calculation, mainly on the results vector.

The table is completed by the error code and value. These error codes can be obtained translating the status vector returned by the `xv_time_segments_mapping` CFI function by calling the function of the EO\_VISIBILITY software library `xv_get_code`.

**Table 86: Error messages and codes**

| Error type | Error message  | Cause and impact          | Error Code                                       | Error No |
|------------|--|---------------------------|--|----------|
| ERR        | Error, wrong orbit Id.                                   | Computation not performed | XV_CFI_TIME_SEGMENTS_MAPPING_ORBIT_STATUS_ERR    | 0        |
| ERR        | Error getting absolute orbit from relative orbit.        | Computation not performed | XV_CFI_TIME_SEGMENTS_MAPPING_REL_TO_ABS_ERR      | 1        |
| ERR        | Error getting relative orbit vector from absolute orbits | Computation not performed | XV_CFI_TIME_SEGMENTS_MAPPING_REF_LATITUDE_ERR    | 2        |
| ERR        | Error computing swath width.                             | Computation not performed | XV_CFI_TIME_SEGMENTS_MAPPING_SWATH_WIDTH_ERR     | 3        |
| ERR        | Error calling zone_vis_time function                     | Computation not performed | XV_CFI_TIME_SEGMENTS_MAPPING_ZONE_VIS_TIME_ERR   | 4        |
| ERR        | Error loading orbit scenario file.                       | Computation not performed | XV_CFI_TIME_SEGMENTS_MAPPING_LOAD_OSF_ERR        | 5        |
| ERR        | Start orbit is less than first orbit in OSF              | Computation not performed | XV_CFI_TIME_SEGMENTS_MAPPING_WRONG_START_ORB_ERR | 6        |
| ERR        | Error, orbits changes found within the input orbit range | Computation not performed | XV_CFI_TIME_SEGMENTS_MAPPING_WRONG_STOP_ORB_ERR  | 7        |
| ERR        | Error allocating memory.                                 | Computation not performed | XV_CFI_TIME_SEGMENTS_MAPPING_MEMORY_ERR          | 8        |
| ERR        | Error sorting segments.                                  | Computation not performed | XV_CFI_TIME_SEGMENTS_MAPPING_SORT_ERR            | 9        |

|      |  |   |   |    |
|------|--|---|---|----|
| ERR  | Error getting relative orbit vector from absolute orbits.                                | Computation not performed   | XV_CFI_TIME_SEGMENTS_MAPPING_ABS_TO_REL_ERR               | 10 |
| ERR  | Error checking extremes of the orbit range.  | Computation not performed   | XV_CFI_TIME_SEGMENTS_MAPPING_CHECK_EXTREMES_ERR           | 11 |
| ERR  | Error calling xv_swath_pos function.   | Computation not performed   | XV_CFI_TIME_SEGMENTS_MAPPING_SWATH_POS_ERR                | 12 |
| ERR  | Error loading swath template file: %s  | Computation not performed   | XV_CFI_TIME_SEGMENTS_MAPPING_SWATH_READ_ERR               | 13 |
| ERR  | Swath file is not a line swath.  | Computation not performed   | XV_CFI_TIME_SEGMENTS_MAPPING_INCORRECT_SWATH_ERR          | 14 |
| WARN | Cannot check segments for start and stop orbits. Incomplete mappings could be generated. | Previous orbit to input start orbit and/or next orbit to the input stop orbit are not in the same orbital change that the input orbit range. It can not be checked whether there are segments missing at the extremes of the orbit range.<br><br>Computation performed. | XV_CFI_TIME_SEGMENTS_MAPPING_NO_CHECK_PERFORMED_WARN      | 15 |
| WARN | Incomplete ascending mapping. %ld more track(s) needed to complete the mapping.          | Computation performed.  | XV_CFI_TIME_SEGMENTS_MAPPING_ASC_INCOMPLETE_MAPPING_WARN  | 16 |
| WARN | Incomplete descending mapping. %ld more track(s) needed to complete the mapping.         | Computation performed.  | XV_CFI_TIME_SEGMENTS_MAPPING_DESC_INCOMPLETE_MAPPING_WARN | 17 |
| ERR  | Geostationary satellite not allowed for this function.                                   | Computation not performed   | XV_CFI_TIME_SEGMENTS_MAPPING_GEO_SAT_ERR                  | 18 |
| WARN | Deprecated function. Use xv_timesegments_compute_mapping instead                         | Computation performed   | XV_CFI_TIME_SEGMENTS_MAPPING_DEPRECATED_WARN              | 19 |

## 7.28 xv\_timesegments\_compute\_mapping

### 7.28.1 Overview

The function `xv_timesegments_compute_mapping` returns groups of visibility segments of a zone within an orbit range introduced by the user. These groups, or mappings, contain a minimum number of time segments needed to cover the zone completely, and fulfil the following conditions:

- Each mapping only contains ascending or descending segments.
- The segments are ordered by the track number.
- Mappings with one segment will be returned if it covers completely the zone.
- A mapping is searched for each track with segments that only contains left/right coverage in the case of ascending/descending segments, and finishes with a track that only contains right/left coverage.
- Incomplete mappings are not returned. This could happen if the number of orbits is insufficient to cover the zone.

Note that different mappings could contain a subset of segments in common. For example in Figure 31 there are two possible different mappings:

- mapping 1: orbits 1, 2, 3, 4.
- mapping 2: orbits 502, 2, 3, 4.

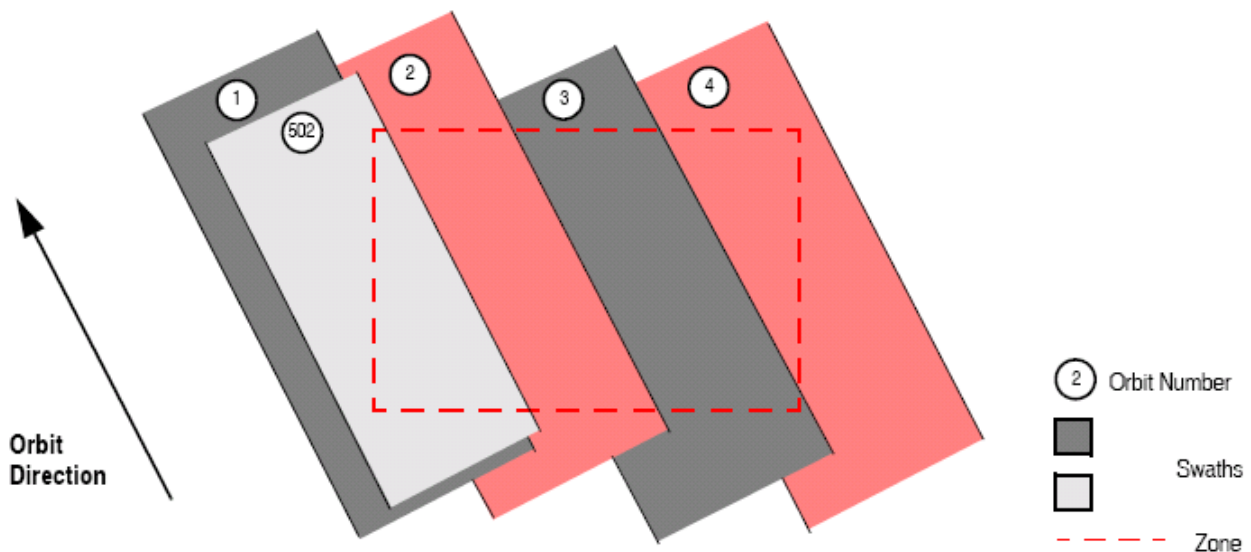

**Figure 31: Different mappings with common segments**

The time intervals (`xv_time_interval`) used by `xv_timesegments_compute_and` can be expressed as UTC times or orbit times (orbit plus seconds and microseconds since ascending node). This intervals express the start time/orbit and last time/orbit for the computations.

In case the time intervals are expressed as orbits, they can be expressed as absolute orbit numbers or in relative orbit and cycle numbers.

The orbit representation (absolute or relative) for the output segments will be the same as in the input orbits. The output segments will contain UTC times and orbit times.

The `xv_timesegments_compute_mapping` requires access to several data structures and files to produce its results:

- the `orbit_id` (`xo_orbit_id`) providing the orbital data. The `orbit_id` can be initialized with the following data or files (see [ORBIT\_SUM]):
  - data for an orbital change
  - Orbit scenario files
  - Predicted orbit files
  - Orbit Event Files (**Note: Orbit Event File is deprecated, only supported for CRYOSAT mission**)
  - Restituted orbit files
  - DORIS Preliminary orbit files
  - DORIS Navigator files
- The `swath_id` (`xv_swath_id`, initialized using `xv_swath_id_init` -section 7.32-), which provides the Instrument Swath data, excluding inertial swath files, describing the area seen by the relevant instrument all along the current orbit.
- Zone data (see section 7.3.7.5 for details)..

## 7.28.2 Calling sequence `xv_timesegments_compute_mapping`

For C programs, the call to `xv_timesegments_compute_mapping` is (input parameters are underlined):

```
#include "explorer_visibility.h"
{
    xo_orbit_id orbit_id = {NULL};
    xv_swath_id swath_id = {NULL};
    xv_zone_info_list zone_info_list;
    xv_time_interval search_interval;
    long num_mappings;
    long *orbit_direction = NULL;
    xv_zonevisibility_interval_list *seg_out = NULL;
    long ierr[XV_NUM_ERR_COMPUTE_MAPPING];

    status = xv_timesegments_compute_mapping(&orbit_id,
                                             &swath_id, &zone_info_list,
                                             &search_interval,
                                             /*outpus*/
                                             &num_mappings,
                                             &orbit_direction, &seg_out,
                                             ierr);

    /* Or, using the run_id */
    long run_id;

    status = xv_timesegments_compute_mapping(&run_id,
                                             &swath_id, &zone_info_list,
                                             &search_interval,
                                             /*outpus*/
                                             &num_mappings,
                                             &orbit_direction, &seg_out,
                                             ierr);
}
```

### 7.28.3 Input parameters *xv\_timesegments\_compute\_mapping*

Table 87: Input parameters of *xv\_timesegments\_compute\_mapping*

| C name          | C type             | Array Element | Description   | Unit (Format) | Allowed Range |
|-----------------|--------------------|---------------|---|---------------|---------------|
| orbit_id        | xo_orbit_id*       | -             | Structure that contains the orbit data                      | -             | -             |
| swath_id        | xv_swath_id*       | -             | Swath id.   | -             | -             |
| zone_info_list  | xv_zone_info_list* | -             | List of zones where the visibility is going to be computed. | -             | -             |
| search_interval | xv_time_interval*  | -             | Interval where the computations are performed               | -             | -             |

## 7.28.4 Output parameters *xv\_timesegments\_compute\_mapping*

Table 88: Output parameters of *xv\_timesegments\_compute\_mapping*

| C name                          | C type                              | Array Element | Description   | Unit (Format) | Allowed Range                             |
|---------------------------------|-------------------------------------|---------------|---|---------------|---|
| <i>xv_time_segments_mapping</i> | long                                |               | Function status flag,<br>= 0 No error<br>> 0 Warnings, results generated<br>< 0 Error, no results generated |               |   |
| <i>num_mappings</i>             | long                                |               | Number of output mappings   |               | $\geq 0$                                  |
| <i>orbit_direction</i>          | long*                               | all           | Direction of the segments of a mapping.   | -             | Complete (see Table 3: segment direction) |
| <i>seg_out</i>                  | <i>xv_visibility_interval_list*</i> | -             | Array with output list of segments. Every position corresponds to one of the mappings.                      | -             | -   |
| <i>ierr</i>                     | long*                               |               | Error status flags  |               |   |

Note 1: The output visibility segments and the coverage are returned as a two-dimensional table where the first index indicates the number of the mapping, and the second one is the number of the segment within the mapping.

Note 2(Memory Management): Note that the memory for the output visibility segments arrays is allocated within the ***xv\_timesegments\_compute\_mapping*** function. So the user will only have to declare those pointers but not to allocate memory for them. However, once the function has returned without error, the user will have the responsibility of freeing the memory for those pointers once they are not used.



### 7.28.5 Warnings and errors

Next table lists the possible error messages that can be returned by the `xv_timesegments_compute_mapping` CFI function after translating the returned status vector into the equivalent list of error messages by calling the function of the EO\_VISIBILITY software library `xv_get_msg`.

This table also indicates the type of message returned, i.e. either a warning (WARN) or an error (ERR), the cause of such a message and the impact on the performed calculation, mainly on the results vector.

The table is completed by the error code and value. These error codes can be obtained translating the status vector returned by the `xv_timesegments_compute_mapping` CFI function by calling the function of the EO\_VISIBILITY software library `xv_get_code`.

**Table 89: Error messages and codes**

| Error type | Error message  | Cause and impact          | Error Code  | Error No |
|------------|--|---------------------------|---|----------|
| ERR        | Error, wrong orbit Id.                                   | Computation not performed | XV_CFI_TIMESEGMENTS_COMPUTE_MAPPING_ORBIT_STATUS_ERR      | 0        |
| ERR        | Error getting absolute orbit from relative orbit.        | Computation not performed | XV_CFI_TIMESEGMENTS_COMPUTE_MAPPING_REL_TO_ABS_ERR        | 1        |
| ERR        | Error getting relative orbit vector from absolute orbits | Computation not performed | XV_CFI_TIMESEGMENTS_COMPUTE_MAPPING_REF_LATITUDE_ERR      | 2        |
| ERR        | Error computing swath width.                             | Computation not performed | XV_CFI_TIMESEGMENTS_COMPUTE_MAPPING_SWATH_WIDTH_ERR       | 3        |
| ERR        | Error calling zone_vis_time function                     | Computation not performed | XV_CFI_TIMESEGMENTS_COMPUTE_MAPPING_ZONE_VISTIME_ERR      | 4        |
| ERR        | Error loading orbit scenario file.                       | Computation not performed | XV_CFI_TIMESEGMENTS_COMPUTE_MAPPING_LOAD_OSF_ERR          | 5        |
| ERR        | Start orbit is less than first orbit in OSF              | Computation not performed | XV_CFI_TIMESEGMENTS_COMPUTE_MAPPING_WORKING_START_ORB_ERR | 6        |
| ERR        | Error, orbits changes found within the input orbit range | Computation not performed | XV_CFI_TIMESEGMENTS_COMPUTE_MAPPING_WRONG_STOP_ORB_ERR    | 7        |
| ERR        | Error allocating memory.                                 | Computation not performed | XV_CFI_TIMESEGMENTS_COMPUTE_MAPPING_MEMORY_ERR            | 8        |
| ERR        | Error sorting segments.                                  | Computation not performed | XV_CFI_TIMESEGMENTS_COMPUTE_MAPPING_SORTING_ERR           | 9        |

|      |  |   | R T_ERR  |    |
|------|--|---|--|----|
| ERR  | Error getting relative orbit vector from absolute orbits.                                | Computation not performed   | XV_CFI_TIMESEGMENTS_COMPUTE_MAPPING_ABS_TO_REL_ERR               | 10 |
| ERR  | Error checking extremes of the orbit range.  | Computation not performed   | XV_CFI_TIMESEGMENTS_COMPUTE_MAPPING_CHECK_EXTREMES_ERR           | 11 |
| ERR  | Error calling xv_swath_pos function.   | Computation not performed   | XV_CFI_TIME_SEGMENTS_MAPPING_SWATH_POS_ERR                       | 12 |
| ERR  | Error loading swath template file: %s  | Computation not performed   | XV_CFI_TIME_SEGMENTS_MAPPING_SWATH_READ_ERR                      | 13 |
| ERR  | Swath file is not a line swath.  | Computation not performed   | XV_CFI_TIME_SEGMENTS_MAPPING_INCORRECT_SWATH_ERR                 | 14 |
| WARN | Cannot check segments for start and stop orbits. Incomplete mappings could be generated. | Previous orbit to input start orbit and/or next orbit to the input stop orbit are not in the same orbital change that the input orbit range. It can not be checked whether there are segments missing at the extremes of the orbit range.<br><br>Computation performed. | XV_CFI_TIMESEGMENTS_COMPUTE_MAPPING_NO_CHECK_PERFORMED_WARN      | 15 |
| WARN | Incomplete ascending mapping. %ld more track(s) needed to complete the mapping.          | Computation performed.  | XV_CFI_TIMESEGMENTS_COMPUTE_MAPPING_ASC_INCOMPLETE_MAPPING_WARN  | 16 |
| WARN | Incomplete descending mapping. %ld more track(s) needed to complete the mapping.         | Computation performed.  | XV_CFI_TIMESEGMENTS_COMPUTE_MAPPING_DESC_INCOMPLETE_MAPPING_WARN | 17 |
| ERR  | Geostationary satellite not allowed for this function.                                   | Computation not performed   | XV_CFI_TIMESEGMENTS_COMPUTE_MAPPING_GEO_SAT_ERR                  | 18 |
| ERR  | Swath id not initialized   | Computation not performed   | XV_CFI_TIMESEGMENTS_COMPUTE_MAPPING_SWATH_INIT_ERR               | 19 |
| ERR  | Error generating swath template file   | Computation not performed   | XV_CFI_TIMESEGMENTS_COMPUTE_MAPPING_GEN_SWATH_ERR                | 20 |
| ERR  | Wrong input time type  | Computation not performed   | XV_CFI_TIMESEGMENTS_COMPUTE_MAPPING_TIME_TYPE_ERR                | 21 |

|     |  |                           |   |    |
|-----|--|---------------------------|---|----|
| ERR | Error computing time to orbit parameters | Computation not performed | XV_CFI_TIMESEGMENTS_COMPUTE_MAPPING_TIME_TO_ORBIT_ERR     | 22 |
| ERR | Error computing UTC time for orbit       | Computation not performed | XV_CFI_TIMESEGMENTS_COMPUTE_MAPPING_GET_UTCTIME_ERR       | 23 |
| ERR | Input file is not a swath file           | Computation not performed | XV_CFI_TIMESEGMENTS_COMPUTE_MAPPING_DETECT_SWATH_TYPE_ERR | 24 |

## 7.29 xv\_gen\_swath

### 7.29.1 Overview

The **xv\_gen\_swath** function generates for the different instrument modes the corresponding instrument swath template file. These template files define the swaths to be used in the segment calculation routines of EO\_VISIBILITY.

The selection of the algorithm to compute the swath points depends on the parameters of the corresponding swath definition found in the instrument swath definition file. The swath point type (geodetic or inertial) and the algorithm to be used is deduced from the geometry and other instrument dependent parameters (see Table 90). There is an example of a swath definition file in the Appendix A.

The instrument swath template file, consists of a header which contains the altitude range of the swath. The data block contains  $n$  locations of the swath (between 50 and 6000, typically 1200) equally spread in time along one orbit. Every swath location contains a list of  $m$  points of the instantaneous swath ( $m \geq 1$ ). For a description of the swath configuration see section 7.1.2 and Figure 8.

For Earth-fixed swaths, the location is given in longitude and latitude, in degrees, for the orbit with a longitude of ascending node of 0.0 degrees. For Inertial swaths, the location is the direction in inertial space (True of Date) in Right Ascension and Declination, in degrees, for the orbit with a Right Ascension of Ascending Node of 0.0 degrees.

The instrument swath template files are only dependent on:

- The instrument swath definition file
- The requested orbit number
- The orbit definition (`orbit_id`).

**Table 90: Swath geometry definition (algorithm)**

| Geometry<br>(XD_Swath_geom_enum)                           | Algorithm description  | Swath point type<br>(XD_Swath_point_type_enum) |
|--|--|--|
| Pointing_Geometry (azimuth, elevation, altitude)           | Swath point computed with <code>xp_target_inter</code> with that azimuth, elevation and altitude   | Geodetic                                       |
| Distance_Geometry (azimuth, elevation, altitude, distance) | Swath point computed with <code>xp_target_ground_range</code> with that azimuth, elevation, altitude and distance                                  | Geodetic                                       |
| Limb_Geometry (azimuth and altitude)                       | Swath point computed with <code>xp_target_altitude</code> with that azimuth and altitude   | Geodetic                                       |
| Inertial_Geometry (azimuth and altitude)                   | Swath point computed with <code>xp_target_altitude</code> with that azimuth and altitude. The swath point is the RA and Declination of the target. | Inertial                                       |
| Sub_Satellite_Geometry (no parameters)                     | Computation of the sub-satellite point   | Geodetic                                       |
| ASAR_Geometry (azimuth, elevation, altitude)               | Specific algorithm for the three swath points for ASAR instrument in Envisat.  | Geodetic                                       |

## 7.29.2 Calling interface

The calling interface of the `xv_gen_swath` CFI function is the following (input parameters are underlined):

```
#include <explorer_visibility.h>
{
    xo_orbit_id orbit_id = {NULL};
    xp_atmos_id atmos_id = {NULL};
    long requested_orbit,
        version_number;
    char *swath_definition_file;
    char swath_file[XD_MAX_STR], *dir_name, *file_class,
        *fh_system;
    long status, ierr[XV_ERR_VECTOR_MAX_LENGTH];

    status = xv_gen_swath (&orbit_id, &atmos_id,
                          &requested_orbit, swath_definition_file,
                          dir_name, swath_file,
                          file_class, &version_number, fh_system,
                          ierr);

    /* Or, using the run_id */
    long run_id;

    status = xv_gen_swath_run (&run_id,
                              &requested_orbit, swath_definition_file,
                              dir_name, swath_file,
                              file_class, &version_number, fh_system,
                              ierr);
}
```

### 7.29.3 Input parameters

The `xv_gen_swath` CFI function has the following input parameters:

**Table 91: Input parameters of `xv_gen_swath` function**

| C name                             | C type                    | Array Element | Description  | Unit (Format)         | Allowed Range |
|------------------------------------|---------------------------|---------------|--|-----------------------|---------------|
| <code>orbit_id</code>              | <code>xo_orbit_id*</code> | -             | Structure that contains the orbit data.  | -                     | -             |
| <code>atmos_id</code>              | <code>xp_atmos_id*</code> | -             | Structure that contains the atmosphere initialisation.<br><br>This parameter determines the atmospheric and raytracing model used for the STF generation. The refraction model in the SDF is not used.               | -                     | -             |
| <code>requested_orbit</code>       | <code>long*</code>        | -             | Orbit for which the instrument swath template file will be calculated.   | absolute orbit number | > 0           |
| <code>swath_definition_file</code> | <code>char*</code>        | -             | File name of the instrument swath definition file  | -                     | -             |
| <code>dir_name</code>              | <code>char*</code>        | -             | Directory where the resulting STF is written (if empty (i.e. ""), the current directory is used)   | -                     | -             |
| <code>swath_file</code>            | <code>char*</code>        | -             | Name for output swath file.<br><br>If empty (i.e. ""), the software will generate the name according to file name specification presented in [FORMATS], in this case the generated name is returned in this variable | -                     | -             |
| <code>file_class</code>            | <code>char*</code>        | -             | File class for output swath file   | -                     | -             |
| <code>version_number</code>        | <code>long*</code>        | -             | Version number of output swath file  | -                     | >= 1          |
| <code>fh_system</code>             | <code>char*</code>        | -             | System field of the output swath file fixed header   | -                     | -             |

### 7.29.4 Output parameters

The output parameters of the `xv_gen_swath` CFI function are:

*Table 92: Output parameters of `xv_gen_swath` function*

| C name                                      | C type             | Array Element | Description (Reference)  | Unit (Format) | Allowed Range |
|---|--------------------|---------------|--|---------------|---------------|
| <code>swath_file</code>                     | <code>char*</code> | -             | Name for output swath file.<br><br><u>This is only an output parameter when it is empty</u> (i.e. "", see description of this parameter in Table 91) | -             | -             |
| <code>ierr[XV_ERR_VECTOR_MAX_LENGTH]</code> | <code>long</code>  | all           | Status vector  | -             | -             |

### 7.29.5 Warnings and errors

Next table lists the possible error messages that can be returned by the **xv\_gen\_swath** CFI function after translating the returned status vector into the equivalent list of error messages by calling the function of the EO\_VISIBILITY software library **xv\_get\_msg** (see [GEN\_SUM]).

This table also indicates the type of message returned, i.e. either a warning (WARN) or an error (ERR), the cause of such a message and the impact on the performed calculation, mainly on the results vector.

The table is completed by the error code and value. These error codes can be obtained translating the status vector returned by the **xv\_gen\_swath** CFI function by calling the function of the EO\_VISIBILITY software library **xv\_get\_code** (see [GEN\_SUM]).

**Table 93: Error messages of xv\_gen\_swath function**

| Error type | Error message   | Cause and impact          | Error Code                           | Error No |
|------------|---|---------------------------|--------------------------------------|----------|
| ERR        | Error, wrong orbit Id.  | Computation not performed | XV_CFI_GEN_SWATH_ORBIT_INIT_ERR      | 0        |
| ERR        | Wrong requested orbit   | Computation not performed | XV_CFI_GEN_SWATH_REQUESTED_ORBIT_ERR | 1        |
| ERR        | Could not get the creation date   | Computation not performed | XV_CFI_GEN_SWATH_CURRENT_TIME_ERR    | 2        |
| ERR        | Error transforming time formats   | Computation not performed | XV_CFI_GEN_SWATH_TIME_CONVERSION_ERR | 3        |
| ERR        | Could not create the filename   | Computation not performed | XV_CFI_GEN_SWATH_CREATE_FILENAME_ERR | 4        |
| ERR        | Error reading swath definition file: %s   | Computation not performed | XV_CFI_GEN_SWATH_SDF_READ_ERR        | 5        |
| ERR        | Error computing the swath points  | Computation not performed | XV_CFI_GEN_SWATH_XV_ALGOR_ERR        | 6        |
| ERR        | Could not write the swath template file to disk                                       | Computation not performed | XV_CFI_GEN_SWATH_WRITE_ERR           | 7        |
| ERR        | Wrong input file name. The file cannot be created                                     | Computation not performed | XV_CFI_GEN_SWATH_WRONG_FILENAME_ERR  | 8        |
| WARN       | Could not find the input directory \"%s\". The current directory will be used instead | Computation performed     | XV_CFI_GEN_SWATH_NO_DIR_WARN         | 9        |
| ERR        | Error allocating memory   | Computation not performed | XV_CFI_GENSWATH_MEMORY_ERR           | 10       |
| ERR        | Geostationary satellite not allowed for this function.                                | Computation not performed | XV_CFI_GENSWATH_GEO_SAT_ERR          | 11       |



## 7.29.6 Executable Program

The `gen_swath` executable program can be called from a Unix shell as:

```
gen_swath  -sat satellite_name
           -sdf swath_definition_file_name
           -file orbit_file_name -orbit orbit_number
           [-tle]
           [-dir dir_name] (current directory by default)
           [-stf swath_template_filename] (empty string by default)
           [-precf file_name] (empty string by default)
           [-fcl file_class] (empty string by default)
           [-vers version] (version = 1 by default)
           [-fhsys fh_system] (empty string by default)
           [-v ]
           [-xl_v ]
           [-xo_v ]
           [-xp_v ]
           [-xv_v ]
           [-help ]
           [-show ]
           {(-tai TAI_time -gps GPS_time -utc UTC_time -ut1 UT1_time) |
           (-tmod time_model -tfile time_reference_data file -trid time_reference
           {(-tm0 time 0 -tm1 time 1) | (-orb0 orbit 0 -orb1 orbit 1) } )}
```

Note that:

- Order of parameters does not matter.
- Bracketed parameters are not mandatory (For example, if **-stf** argument is not provided, `instrument_swath_file_name_suffix` is considered to be an empty string).
- Options between curly brackets and separated by a vertical bar are mutually exclusive (For example, that lines 3 and 4 are mutually exclusive).
- [-tle] this options must be provided if input file is a Two Line Elements file.
- [-xl\_v ] option for EO\_LIB Verbose mode.
- [-xo\_v ] option for EO\_ORBIT Verbose mode.
- [-xp\_v ] option for EO\_POINTING Verbose mode.
- [-xv\_v ] option for EO\_VISIBILITY Verbose mode.
- [-v ] option for Verbose mode for all libraries (default is Silent).
- [-show ] displays the inputs of the function and the results.
- Possible values for `satellite_name`: ERS1, ERS2, ENVISAT, METOP1, METOP2, METOP3, CRYOSAT, ADM, GOCE, SMOS, TERRASAR, EARTHCARE, SWARM\_A, SWARM\_B,

SWARM\_C, SENTINEL\_1A, SENTINEL\_1B, SENTINEL\_1C, SENTINEL\_2A, SENTINEL\_2B, SENTINEL\_2C, SENTINEL\_3A, SENTINEL\_3B, SENTINEL\_3C, JASON\_CSA, JASON\_CSB, METOP\_SG\_A1, METOP\_SG\_A2, METOP\_SG\_A3, METOP\_SG\_B1, METOP\_SG\_B2, METOP\_SG\_B3, SENTINEL\_5P, SEOSAT, GENERIC.

- Precise propagation is used if prefile is provided.
- **Important:** The atmospheric model used for the STF generation is taken from the “Refraction” parameters in the SDF. The allowed values for the Refraction model in the input SDF are NO\_REF, STD\_REF or PRED\_REF. Note the user defined models are not allowed.

Example:

```
gen_swath -sat ENVISAT -orbit 2000 -osf ACCEPTANCE_OSF.N1  
-sdf SDF_MERIS.1200pts.N1 -xv_v  
-dir ./gen_swath
```

## 7.30 xv\_gen\_swath\_no\_file

### 7.30.1 Overview

The `xv_gen_swath_no_file` function generates for the different instrument modes the corresponding instrument swath template data.

The aim of this function is to provide another interface for the function `xv_gen_swath` in which the swath data is returned in a swath structure instead to be save to a file.

### 7.30.2 Calling interface

The calling interface of the `xv_gen_swath_no_file` CFI function is the following (input parameters are underlined):

```
#include <explorer_visibility.h>
{
    xo_orbit_id orbit_id = {NULL};
    xp_atmos_id atmos_id = {NULL};
    long requested_orbit;
    xd_sdf_file *sdf;
    xd_stf_file *stf;

    long status, ierr[XV_ERR_VECTOR_MAX_LENGTH];
    status = xv_gen_swath_no_file (&orbit_id, &atmos_id,
                                   &requested_orbit,
                                   &sdf, &stf,
                                   ierr);

    /* Or, using the run_id */
    long run_id;

    status = xv_gen_swath_no_file_run (&run_id,
                                       &requested_orbit,
                                       &sdf, &stf,
                                       ierr);
}
```

### 7.30.3 Input parameters

The `xv_gen_swath_no_file` CFI function has the following input parameters:

**Table 94: Input parameters of `xv_gen_swath_no_file` function**

| C name          | C type       | Array Element | Description (Reference)  | Unit (Format)         | Allowed Range |
|-----------------|--------------|---------------|--|-----------------------|---------------|
| orbit_id        | xo_orbit_id* | -             | Structure that contains the orbit data.  | -                     | -             |
| atmos_id        | xp_atmos_id* | -             | Structure that contains the atmosphere initialisation.<br><br>This parameters is needed only if the swath definition file requires atmosphere initialisation. This happens when the refraction model in the SDF is USER_REF or PRED_REF. | -                     | -             |
| requested_orbit | long*        | -             | Orbit for which the instrument swath template file will be calculated.   | absolute orbit number | > 0           |
| sdf             | xd_sdf_file  | -             | Swath definition file structure data. This structure is defined in [D_H_SUM] and can be got by reading a swath definition file with the CFI function <b>xd_read_sdf</b> .  | -                     | -             |
| file_class      | char*        | -             | File class for output swath data   | -                     | -             |
| version_number  | long*        | -             | Version number of output swath data  | -                     | >= 1          |
| fh_system       | char*        | -             | System field of the output swath file fixed header data  | -                     | -             |

### 7.30.4 Output parameters

The output parameters of the `xv_gen_swath_no_file` CFI function are:

**Table 95: Output parameters of `xv_gen_swath_no_file` function**

| C name | C type      | Array Element | Description (Reference)                       | Unit (Format) | Allowed Range |
|--------|-------------|---------------|---|---------------|---------------|
| stf    | xd_stf_file | -             | Swath Template structure defined in [D_H_SUM] | -             | -             |

---

|                                    |      |     |               |   |   |
|------------------------------------|------|-----|---------------|---|---|
| ierr[XV_ERR_VECTOR_<br>MAX_LENGTH] | long | all | Status vector | - | - |
|------------------------------------|------|-----|---------------|---|---|

### **7.30.5 Warnings and errors**

The error and warning messages and codes for **xv\_gen\_swath\_no\_file** are the same than for **xv\_gen\_swath** (see Table 93) .

The error messages/codes can be returned by the CFI function **xv\_get\_msg/xv\_get\_code** after translating the returned status vector into the equivalent list of error messages/codes. The function identifier to be used in that functions is **XV\_GEN\_SWATH\_ID** (from Table 2).

## 7.31 xv\_gen\_scf

### 7.31.1 Overview

The `xv_gen_scf` function generates a Swath Control file. This file contains a list of visibility segments together with some features linked to the segment that are used for the visualisation of the segment in the ESOV tool.

In order to generate the file, the same `xo_orbit_id` variable that was used for the generation of the visibility segments has to be provided. Moreover, this `xo_orbit_id` has to be implemented with one of the following functions:

- `xo_orbit_init_def`
- `xo_orbit_init_file` with an orbit scenario file (or an orbit event file used as an orbit scenario. **Note: Orbit Event File is deprecated, only supported for CRYOSAT mission**).

### 7.31.2 Calling interface

The calling interface of the `xv_gen_scf` CFI function is the following (input parameters are underlined):

```
#include <explorer_visibility.h>
{
    xo_orbit_id orbit_id = {NULL};
    char instrument[XD_MAX_STR];
    long version_number;
    char *file_class, *fh_system;
    char dir_name[XD_MAX_STR], scf_filename[XD_MAX_STR];
    long status, ierr[XV_NUM_ERR_GEN_SCF];
    long number_segments;
    long *bgn_orbit, *bgn_second, *bgn_microsec;
    long *end_orbit, *end_second, *end_microsec;
    xd_scf_appear * appearance;
    status = xv_gen_scf (&orbit_id, instrument, number_segments,
                        bgn_orbit, bgn_second, bgn_microsec,
                        end_orbit, end_second, end_microsec,
                        appearance,
                        dir_name, scf_filename,
                        file_class, version_number, fh_system,
                        ierr);

    /* Or, using the run_id */
    long run_id;
    status = xv_gen_scf_run (&run_id, instrument, number_segments,
                            bgn_orbit, bgn_second, bgn_microsec,
```

```

    end_orbit, end_second, end_microsec,
    appearance,
    dir_name, scf_filename,
    file_class, &version_number, fh_system,
    ierr);
}

```

### 7.31.3 Input parameters

The `xv_gen_scf` CFI function has the following input parameters:

**Table 96: Input parameters of `xv_gen_scf` function**

| C name          | C type        | Array Element | Description (Reference)   | Unit (Format) | Allowed Range |
|-----------------|---------------|---------------|---|---------------|---------------|
| orbit_id        | xo_orbit_id*  | -             | Structure that contains the orbit data.   | -             | -             |
| instrument      | char*         | -             | Instrument name   | -             | -             |
| number_segments | long          | -             | Number of input segments  | -             |               |
| bgn_orbit       | long*         | -             | Array of absolute orbit numbers for the beginning of the segments   | -             | > 0           |
| bgn_second      | long*         | -             | Array of seconds elapsed since ANX for the beginning of the segments  | -             | > =0          |
| bgn_microsec    | long*         | -             | Array of microseconds within a second for the beginning of the segments   | -             | > =0          |
| end_orbit       | long*         | -             | Array of absolute orbit numbers for the end of the segments   | -             | > 0           |
| end_second      | long*         | -             | Array of seconds elapsed since ANX for the end of the segments  | -             | > =0          |
| end_microsec    | long*         | -             | Array of microseconds within a second for the end of the segments   | -             | > =0          |
| appearance      | xd_scf_appear | -             | Array with the structures containing the appearance for every segment (see [D_H_SUM])   | -             | -             |
| dir_name        | char*         | -             | Directory where the resulting STF is written (if empty (i.e. ""), the current directory is used)                                      | -             | -             |
| scf_filename    | char*         | -             | Name for output swath file.<br>If empty (i.e. ""), the software will generate the name according to file name specification presented | -             | -             |

|                |       |   |  |   |      |
|----------------|-------|---|--|---|------|
|                |       |   | in [FORMATS], in this case the generated name is returned in this variable |   |      |
| file_class     | char* | - | File class for output file   | - | -    |
| version_number | long* | - | Version number of output file  | - | >= 0 |
| fh_system      | char* | - | System field of the output file fixed header                               | - | -    |

### 7.31.4 Output parameters

The output parameters of the `xv_gen_scf` CFI function are:

**Table 97: Output parameters of `xv_gen_scf` function**

| C name                   | C type | Array Element | Description (Reference)   | Unit (Format) | Allowed Range |
|--------------------------|--------|---------------|---|---------------|---------------|
| scf_filename             | char*  | -             | Name for output SCF.<br><u>This is only an output parameter when it is empty</u> (i.e. “”; see description of this parameter in Table 96) | -             | -             |
| ierr[XV_NUM_ERR_GEN_SCF] | long   | all           | Status vector   | -             | -             |



### 7.31.5 Warnings and errors

Next table lists the possible error messages that can be returned by the **xv\_gen\_scf** CFI function after translating the returned status vector into the equivalent list of error messages by calling the function of the EO\_VISIBILITY software library **xv\_get\_msg** (see [GEN\_SUM]).

This table also indicates the type of message returned, i.e. either a warning (WARN) or an error (ERR), the cause of such a message and the impact on the performed calculation, mainly on the results vector.

The table is completed by the error code and value. These error codes can be obtained translating the status vector returned by the **xv\_gen\_scf** CFI function by calling the function of the EO\_VISIBILITY software library **xv\_get\_code** (see [GEN\_SUM]).

**Table 98: Error messages of xv\_gen\_scf function**

| Error type | Error message   | Cause and impact          | Error Code                                 | Error No |
|------------|---|---------------------------|--|----------|
| ERR        | No segments to write  | Computation not performed | XV_CFI_GENSCF_NO_SEGMENTS_ERR              | 0        |
| ERR        | The orbit has not been initialised  | Computation not performed | XV_CFI_GENSCF_ORBIT_INIT_ERR               | 1        |
| ERR        | Wrong orbit initialisation mode   | Computation not performed | XV_CFI_GENSCF_ORBIT_INIT_MODE_ERR          | 2        |
| ERR        | Could not get the creation date   | Computation not performed | XV_CFI_GENSCF_CURRENT_TIME_ERR             | 3        |
| ERR        | Could not get orbit number for the orbit = %ld  | Computation not performed | XV_CFI_GENSCF_ORBIT_TO_TIME_CONVERSION_ERR | 4        |
| ERR        | Error transforming time formats   | Computation not performed | XV_CFI_GENSCF_TIME_CONVERSION_ERR          | 5        |
| ERR        | Could not create the filename   | Computation not performed | XV_CFI_GENSCF_CREATE_FILENAME_ERR          | 6        |
| ERR        | Could not get orbital information for orbit %ld                                       | Computation not performed | XV_CFI_GENSCF_GET_ORBIT_INFO_ERR           | 7        |
| ERR        | Wrong input file name. The file cannot be created                                     | Computation not performed | XV_CFI_GENSCF_WRONG_FILENAME_ERR           | 8        |
| ERR        | Could not write the swath control file to disk  | Computation not performed | XV_CFI_GENSCF_WRITE_ERR                    | 9        |
| WARN       | Could not find the input directory \"%s\". The current directory will be used instead | Computation performed     | XV_CFI_GENSCF_NO_DIR_WARN                  | 10       |

## 7.32 xv\_swath\_id\_init

### 7.32.1 Overview

The `xv_swath_id_init` function initializes the swath ID. It can be initialized with the following data:

- Swath definition data
- Swath template data
- Swath definition file
- Swath template file

Once initialized, the swath data is stored in internal structures pointed by swath id.

### **7.32.2 Calling sequence of `xv_swath_id_init`**

For C programs, the call to `xv_swath_id_init` is (input parameters are underlined):

```
#include "explorer_visibility.h"
{
    xv_swath_info swath_info;
    xp_atmos_id atmos_id = {NULL};
    xv_swath_id swath_id = {NULL};
    long ierr[XV_NUM_ERR_SWATH_ID_INIT], status;

    status = xv_swath_id_init(&swath_info,
                             &atmos_id,
                             &swath_id,
                             ierr);
}
```

### 7.32.3 Input parameters *xv\_swath\_id\_init*

Table 99: Input parameters of *xv\_swath\_id\_init*

| C name     | C type        | Array Element | Description                      | Unit (Format) | Allowed Range |
|------------|---------------|---------------|----------------------------------|---------------|---------------|
| swath_info | xv_swath_info | -             | Swath initialisation information | -             | -             |
| atmos_id   | xp-atmos_id   | -             | Atmos ID                         | -             | -             |

### 7.32.4 Output parameters *xv\_swath\_id\_init*

Table 100: Output parameters of *xv\_swath\_id\_init*

| C name           | C type      | Array Element | Description   | Unit (Format) | Allowed Range |
|------------------|-------------|---------------|---|---------------|---------------|
| xv_swath_id_init | long        |               | Function status flag,<br>= 0 No error<br>> 0 Warnings, results generated<br>< 0 Error, no results generated |               |               |
| swath_id         | xv_swath_id | -             | Swath ID.   |               |               |
| ierr             | long[]      |               | Error status flags  |               |               |

### 7.32.5 Warnings and errors

Next table lists the possible error messages that can be returned by the **xv\_swath\_id\_init** CFI function after translating the returned status vector into the equivalent list of error messages by calling the function of the EO\_VISIBILITY software library **xv\_get\_msg**.

This table also indicates the type of message returned, i.e. either a warning (WARN) or an error (ERR), the cause of such a message and the impact on the performed calculation, mainly on the results vector.

The table is completed by the error code and value. These error codes can be obtained translating the status vector returned by the **xv\_swath\_id\_init** CFI function by calling the function of the EO\_VISIBILITY software library **xv\_get\_code**.

**Table 101: Error messages and codes**

| Error type | Error message                                | Cause and impact          | Error Code                                       | Error No |
|------------|--|---------------------------|--|----------|
| ERR        | Wrong input initialization type              | Computation not performed | XV_CFI_SWATH_ID_INIT_TYPE_ERR                    | 0        |
| ERR        | Expected input data not found for input type | Computation not performed | XV_CFI_SWATH_ID_INIT_WRONG_INPUT_COMBINATION_ERR | 1        |
| ERR        | Error: swath id is initialized               | Computation not performed | XV_CFI_SWATH_ID_INIT_SWATH_INIT_STATUS_ERR       | 2        |
| ERR        | Error allocating memory                      | Computation not performed | XV_CFI_SWATH_ID_INIT_MEMORY_ERR                  | 3        |
| ERR        | Error cloning swath definition structure     | Computation not performed | XV_CFI_SWATH_ID_INIT_SDF_CLONE_ERR               | 4        |
| ERR        | Error cloning swath template structure       | Computation not performed | XV_CFI_SWATH_ID_INIT_STF_CLONE_ERR               | 5        |
| ERR        | Error linking ids                            | Computation not performed | XV_CFI_SWATH_ID_INIT_LINK_ID_ERR                 | 6        |

## **7.33 xv\_swath\_id\_close**

### **7.33.1 Overview**

The `xv_swath_id_close` function frees the data allocated in the swath ID.

### **7.33.2 Calling sequence of `xv_swath_id_close`**

For C programs, the call to `xv_swath_id_close` is (input parameters are underlined):

```
#include"explorer_visibility.h"
{
    xv_swath_id swath_id = {NULL};
    long ierr[XV_NUM_ERR_SWATH_ID_CLOSE], status;

    status = xv_swath_id_close(&swath_id, ierr);
}
```

### 7.33.3 Input parameters *xv\_swath\_id\_close*

Table 102: Input parameters of *xv\_swath\_id\_close*

| C name   | C type      | Array Element | Description | Unit (Format) | Allowed Range |
|----------|-------------|---------------|-------------|---------------|---------------|
| swath_id | xv_swath_id | -             | Swath ID.   |               |               |

### 7.33.4 Output parameters *xv\_swath\_id\_close*

Table 103: Output parameters of *xv\_swath\_id\_close*

| C name            | C type | Array Element | Description   | Unit (Format) | Allowed Range |
|-------------------|--------|---------------|---|---------------|---------------|
| xv_swath_id_close | long   |               | Function status flag,<br>= 0 No error<br>> 0 Warnings, results generated<br>< 0 Error, no results generated |               |               |
| ierr              | long[] |               | Error status flags  |               |               |



### 7.33.5 Warnings and errors

Next table lists the possible error messages that can be returned by the `xv_swath_id_close` CFI function after translating the returned status vector into the equivalent list of error messages by calling the function of the EO\_VISIBILITY software library `xv_get_msg`.

This table also indicates the type of message returned, i.e. either a warning (WARN) or an error (ERR), the cause of such a message and the impact on the performed calculation, mainly on the results vector.

The table is completed by the error code and value. These error codes can be obtained translating the status vector returned by the `xv_swath_id_close` CFI function by calling the function of the EO\_VISIBILITY software library `xv_get_code`.

**Table 104: Error messages and codes**

| Error type | Error message                | Cause and impact          | Error Code                             | Error No |
|------------|------------------------------|---------------------------|--|----------|
| ERR        | Could not close the swath id | Computation not performed | XV_CFI_SWATH_ID_CLOS<br>E_WRONG_ID_ERR | 0        |

## **7.34 xv\_swath\_set\_id\_data**

### **7.34.1 Overview**

The `xv_swath_set_id_data` function sets the values of the swath ID internal structure according to inputs.

### **7.34.2 Calling sequence of `xv_swath_set_id_data`**

For C programs, the call to `xv_swath_set_id_data` is (input parameters are underlined):

```
#include"explorer_visibility.h"
{
    xv_swath_id swath_id = {NULL};
    xv_swath_info swath_info;

    status = xv_swath_set_id_data(&swath_id, &swath_info);
}

```

### 7.34.3 Input parameters *xv\_swath\_set\_id\_data*

Table 105: Input parameters of *xv\_swath\_set\_id\_data*

| C name     | C type        | Array Element | Description       | Unit (Format) | Allowed Range |
|------------|---------------|---------------|-------------------|---------------|---------------|
| swath_id   | xv_swath_id   | -             | Swath ID.         |               |               |
| swath_info | xv_swath_info | -             | Swath information |               |               |

### 7.34.4 Output parameters *xv\_swath\_set\_id\_data*

Table 106: Output parameters of *xv\_swath\_set\_id\_data*

| C name                      | C type | Array Element | Description   | Unit (Format) | Allowed Range |
|-----------------------------|--------|---------------|---|---------------|---------------|
| <i>xv_swath_set_id_data</i> | long   |               | Function status flag,<br>= 0 No error<br>> 0 Warnings, results generated<br>< 0 Error, no results generated |               |               |

### ***7.34.5 Warnings and errors***

This function does not return any errors.

## **7.35 xv\_swath\_get\_id\_data**

### **7.35.1 Overview**

The `xv_swath_get_id_data` function gets the values stored in the swath ID internal structure.

### **7.35.2 Calling sequence of `xv_swath_get_id_data`**

For C programs, the call to `xv_swath_get_id_data` is (input parameters are underlined):

```
#include"explorer_visibility.h"
{
    xv_swath_id swath_id = {NULL};
    xv_swath_info swath_info;

    status = xv_swath_get_id_data(&swath_id, &swath_info);
}
```

### 7.35.3 Input parameters *xv\_swath\_get\_id\_data*

Table 107: Input parameters of *xv\_swath\_get\_id\_data*

| C name   | C type      | Array Element | Description | Unit (Format) | Allowed Range |
|----------|-------------|---------------|-------------|---------------|---------------|
| swath_id | xv_swath_id | -             | Swath ID.   |               |               |

### 7.35.4 Output parameters *xv\_swath\_get\_id\_data*

Table 108: Output parameters of *xv\_swath\_get\_id\_data*

| C name               | C type        | Array Element | Description   | Unit (Format) | Allowed Range |
|----------------------|---------------|---------------|---|---------------|---------------|
| xv_swath_get_id_data | long          |               | Function status flag,<br>= 0 No error<br>> 0 Warnings, results generated<br>< 0 Error, no results generated |               |               |
| swath_info           | xv_swath_info | -             | Swath information   |               |               |



### ***7.35.5 Warnings and errors***

This function does not return any errors.

## 7.36 xv\_zonevistime\_coverage

### 7.36.1 Overview

The `xv_zonevistime_coverage` function computes the portion of the input zone that is covered by a swath during a set of input time visibility intervals (also called segments). The user has to initialize the input structure of type `xv_zonevisibility_coverage_in` (see Table 4) in order to provide the required information for the computation: zone, swath, attitude definition, orbit\_id, list of visibility times. Note that the `visibility_interval_list` field is of type `xv_zonevisibility_interval_list` (see Table 4) that is the output of the `xv_zonevistime_compute` (section 7.36) function.

The following outputs are returned in the `xv_zonevisibility_coverage_out` struct (assuming that intervals are numbered from 0 to N-1 as stored in the array `visibility_interval` within `visibility_interval_list`, N is the `num_rec` field within `visibility_interval_list`):

- 1) The **area** of the zone in Km<sup>2</sup> (`zone_area` field);
- 2) The **total coverage** (`total_coverage` field): this is the percentage of zone covered by all intervals, i.e. 100 minus the percentage of zone not covered by any interval;
- 3) The **coverage per interval** (`coverage_per_interval` field): this is an array of size N that contains the coverage percentages computed considering only one interval. Item of the array with index i (0,1,2,...N-1) is the percentage of zone covered by the interval i (0,1,2,...N-1) only.
- 4) The **coverage per number of intervals** (`coverage_by_N_intervals` field): this is an array of size N that contains the percentages of zone covered by exactly 1,2,...,N intervals. Item with index i (0,1,2,...N-1) is the percentage of the zone covered by exactly i+1 (1,2,...,N) intervals. This array can be used to evaluate how much segments are overlapping. Ideally, with segments not overlapping, only the first item of this array should be different from zero, and should be close to the total coverage. If other items of the array are different from zero, this means that portions of the zone are covered by more than one segment;
- 5) The **cumulative coverage** (`cumulative_coverage` field): this is an array of size N that contains the cumulative coverage percentage. Item with index i (0,1,2,...N-1) is the percentage of zone covered by intervals 0,1,2...i+1 considered together. This output considers the order in which time segments are provided. For example, if intervals are sorted by time, this output can be used to evaluate when a target coverage percentage is reached.

The computation is performed by means of a grid of points inside the zone. The portion of these points that are within the swath gives the percentage of area covered. The precision of the computation then depends on the distance between points. Two ways of computing the points can be provided by the user via the `type_coverage` field:

- 1) `XV_COVERAGE_FIXED_DISTANCE`: a fixed distance between points is used. The value of these distance is provided by the user (in kilometers);
- 2) `XV_COVERAGE_PERCENTAGE_PRECISION`: the required percentage precision is provided by the user. The function computes internally the distance needed to achieve the requested precision. The distance is computed in a way that the area of the zone computed with the grid created with such distance

is close to the expected one (computed by analytical methods) by a percentage equal or better than input percentage precision. That is, if *area\_zone* is the zone area computed analytically and *area\_grid* is the area of the zone computed with the grid, the accuracy percentage is defined as:

$$\text{percen\_accuracy} = 100. * (1 - \text{abs}(\text{area\_zone} - \text{area\_grid}) / \text{area\_zone})$$

The selected distance fulfills that *percen\_accuracy* is greater or equal to input percentage precision. That means that the closer the input percentage precision to 100% the more accurate are the computations.

**WARNING:** The user has to be aware that requesting a small distance or a big value for precision increase the number of points to be analyzed and this has an impact on performances.

The following example is presented to explain how this function operates:

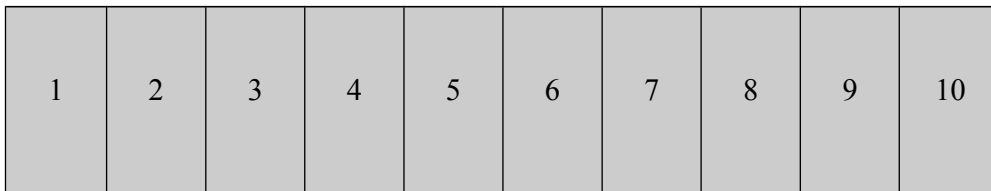

Fig. 1  
Zone split into 10 tiles

A simplified representation of the input zone is given in Fig. 1: the zone is split into 10 tiles of same size.

Three time intervals are provided as input, they are identified with their indexes: 0,1,2

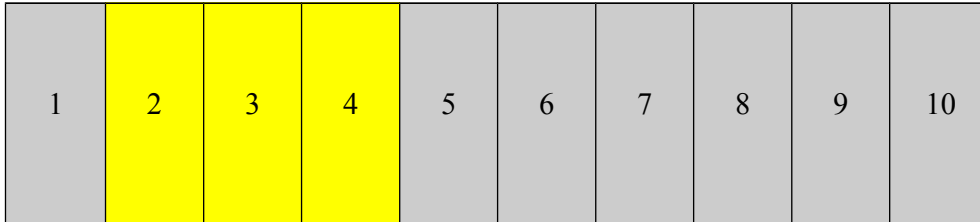

Fig. 2  
Portion of Zone covered by segment 0 only

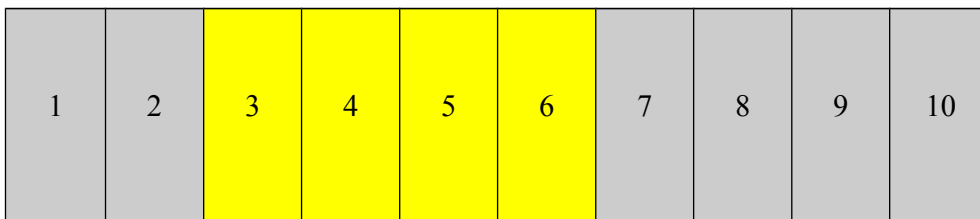

Fig. 3  
Portion of Zone covered by segment 1 only

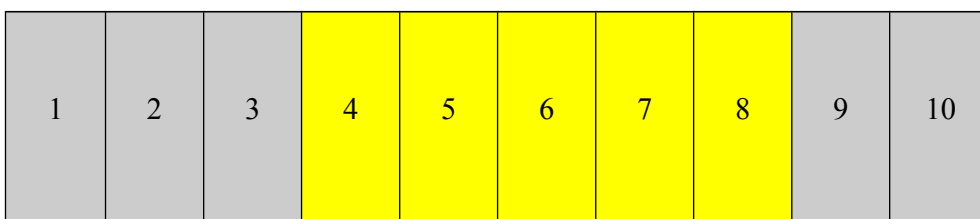

Fig. 4  
Portion of Zone covered by segment 2 only

During time interval 0, tiles 2,3,4 are covered, see Fig. 2.

During time interval 1, tiles 3,4,5,6 are covered, see Fig. 3

During time interval 2, tiles 4,5,6,7,8 are covered, see Fig. 4.

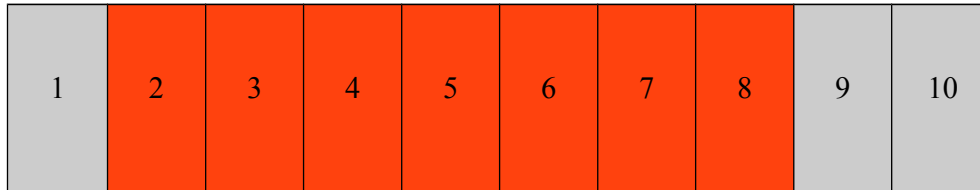

Fig. 5

Total coverage

Considering all three segments, 7 tiles of the zone (2 to 8) are covered, this corresponds to 70% of the whole zone (see Fig. 5). Therefore, if *cov\_out* is the output variable of type *xv\_zonevisibility\_coverage\_out*:

**`cov_out.total_coverage = 70`**

intervals 0,1,2 cover respectively 3,4,5 tiles corresponding to 30%, 40%, 50% of the whole zone. Therefore:

**`cov_out.coverage_per_interva[0] = 30`**

**`cov_out.coverage_per_interva[1] = 40`**

**`cov_out.coverage_per_interva[2] = 50`**

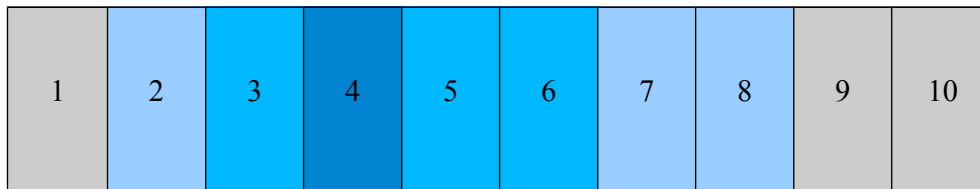

Fig. 6

Coverage by N segments

Fig. 6 details the computation of the *coverage\_by\_N\_intervals* field. Tiles with same colors are covered by the same number of segments.

Tile 2 is covered only by interval 0. Tiles 7,8 are covered only by interval 4.

Therefore tiles 2,7,8 are covered by only one interval. This corresponds to 30% of the whole zone. Therefore:

**`cov_out.coverage_by_N_intervals[0] = 30`**

Similarly tiles 3,5,6 are covered by only 2 intervals and tile 4 is covered by all 3 segments:

Therefore:

**`cov_out.coverage_by_N_intervals[1] = 30`**

**`cov_out.coverage_by_N_intervals[2] = 10`**

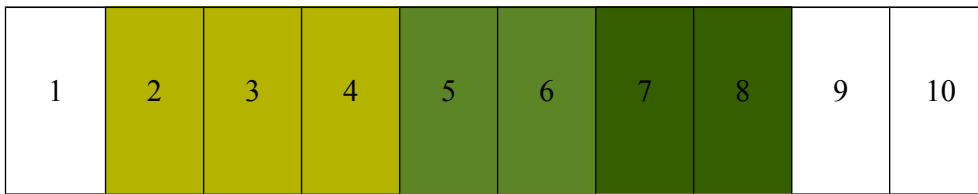

Fig. 7

Cumulative Coverage

Fig. 7 details the computation of the `cumulative_coverage` field. Tiles with same color are those tiles that are covered by a segment but not but the previous ones in the list.

Item 0 is the coverage of the first segment only, that is tiles 2,3,4, i.e. 30%.

Item 1 is the cumulative coverage of the first and second segments, that is tiles 2,3,4,5,6, that is 50%.

item 2 is the cumulative coverage of the first the second and third segment, that is tiles 2,3,4,5,6,7,8 that is 70%. Therefore:

**`cov_out.cumulative_coverage [0] = 30`**

**`cov_out.cumulative_coverage [1] = 50`**

**`cov_out.cumulative_coverage [2] = 70`**

### **7.36.2 Calling sequence of `xv_zonevistime_coverage`**

For C programs, the call to `xv_zonevistime_coverage` is (input parameters are underlined):

```
#include"explorer_visibility.h"
{
    xv_zonevisibility_coverage_in  zone_cov_in;
    xv_zonevisibility_coverage_out zone_cov_out;
    long ierr[XV_NUM_ERR_ZONEVISTIME_COVERAGE], status;

    status = xv_zonevistime_coverage(&zone_cov_in,
                                     &zone_cov_out,
                                     ierr);
}
```

### 7.36.3 Input parameters *xv\_zonevistime\_coverage*

Table 109: Input parameters of *xv\_zonevistime\_coverage*

| C name      | C type                        | Array Element | Description                           | Unit (Format) | Allowed Range |
|-------------|-------------------------------|---------------|---------------------------------------|---------------|---------------|
| zone_cov_in | xv_zonevisibility_coverage_in | -             | Inputs for zone coverage computations | -             | -             |

### 7.36.4 Output parameters *xv\_zonevistime\_coverage*

Table 110: Output parameters of *xv\_zonevistime\_coverage*

| C name                  | C type                      | Array Element | Description   | Unit (Format) | Allowed Range |
|-------------------------|-----------------------------|---------------|---|---------------|---------------|
| xv_zonevistime_coverage | long                        |               | Function status flag,<br>= 0 No error<br>> 0 Warnings, results generated<br>< 0 Error, no results generated |               |               |
| zone_cov_out            | xv_zonevistime_coverage_out | -             | Zone coverage output.   |               |               |
| ierr                    | long[]                      |               | Error status flags  |               |               |

Note: in the output struct *xv\_zonevistime\_coverage\_out*, all the arrays are allocated dynamically and the user is responsible for freeing this allocated memory.

### 7.36.5 Warnings and errors

Next table lists the possible error messages that can be returned by the `xv_zonevistime_coverage` CFI function after translating the returned status vector into the equivalent list of error messages by calling the function of the EO\_VISIBILITY software library `xv_get_msg`.

This table also indicates the type of message returned, i.e. either a warning (WARN) or an error (ERR), the cause of such a message and the impact on the performed calculation, mainly on the results vector.

The table is completed by the error code and value. These error codes can be obtained translating the status vector returned by the `xv_zonevistime_coverage` CFI function by calling the function of the EO\_VISIBILITY software library `xv_get_code`.

**Table 111: Error messages and codes**

| Error type | Error message                     | Cause and impact          | Error Code  | Error No |
|------------|-----------------------------------|---------------------------|---|----------|
| ERR        | Name of zone id is empty.         | Computation not performed | XV_CFI_ZONEVISTIME_COVERAGE_ZONE_ID_EMPTY_ERR     | 0        |
| ERR        | Error reading zone database.      | Computation not performed | XV_CFI_ZONEVISTIME_COVERAGE_READ_ZONE_DB_FILE_ERR | 1        |
| ERR        | Error cloning zone                | Computation not performed | XV_CFI_ZONEVISTIME_COVERAGE_CLONE_ZONE_ERR        | 2        |
| ERR        | Error creating point database     | Computation not performed | XV_CFI_ZONEVISTIME_COVERAGE_CREATE_DB_ERR         | 3        |
| ERR        | Error allocating memory           | Computation not performed | XV_CFI_ZONEVISTIME_COVERAGE_MEMORY_ERR            | 4        |
| ERR        | Error in zonevistime computations | Computation not performed | XV_CFI_ZONEVISTIME_COVERAGE_ZVT_COMPUTE_ERR       | 5        |



## 8 RUNTIME PERFORMANCES

The library performance has been measured by dedicated test procedures run in 5 different platforms under the below specified machines:

| <i>OS ID</i>   | <i>Processor</i>                                    | <i>OS</i>                                 | <i>RAM</i> |
|----------------|---|---|------------|
| LINUX64        | Intel(R) Xeon(R) CPU E5-2470 0 @ 2.30GHz (16 cores) | GNU LINUX 2.6.24-16-generic (Ubuntu 8.04) | 16 GB      |
| LINUX32_LEGACY | Intel(R) Core(TM)2 Quad CPU Q8400 @ 2.66GHz         | GNU LINUX 2.6.24-16-generic (Ubuntu 8.04) | 4 GB       |
| LINUX64_LEGACY | Intel(R) Core(TM)2 Quad CPU Q8400 @ 2.66GHz         | GNU LINUX 2.6.24-16-generic (Ubuntu 8.04) | 4 GB       |
| MACIN64        | Intel Core i7 4 cores @2,6 GHz                      | MAC OSX V10.9                             | 16 GB      |
| WINDOWS        | Intel(R) Core(TM)2 i5-2450M CPU @ 2.50GHz           | Microsoft Windows 7                       | 6 GB       |

The table below shows the time (in milliseconds - ms) each function takes to be run under each platform:

| <b>Function ID</b>  | <b>WINDOWS</b> | <b>LINUX64</b> | <b>LINUX64_LEGACY</b> | <b>LINUX32_LEGACY</b> | <b>MACIN64</b> |
|---|----------------|----------------|-----------------------|-----------------------|----------------|
| xv_swathpos_compute   | 0.050800       | 0.034000       | 0.062000              | 0.045000              | 0.019000       |
| xv_zonevistime_compute * 50 orbits                                | 36.230000      | 28.299999      | 46.400002             | 42.000000             | 34.900002      |
| xv_zonevistime_coverage * Percentage precision = 75% (5 segments) | 2641.000000    | 2310.000000    | 3770.000000           | 3330.000000           | 2990.000000    |
| xv_timesegments_compute_not * 34 segments                         | 0.033600       | 0.021600       | 0.026800              | 0.043300              | 0.013700       |
| xv_timesegments_compute_or * 34 segments                          | 0.038110       | 0.023300       | 0.031400              | 0.047100              | 0.016800       |
| xv_timesegments_compute_and * 34 segments                         | 0.056130       | 0.026200       | 0.032300              | 0.051300              | 0.019200       |
| xv_timesegments_compute_sort * 34 segments                        | 0.051000       | 0.030000       | 0.030000              | 0.040000              | 0.020000       |
| xv_timesegments_compute_merge * 34 segments                       | 0.048160       | 0.021900       | 0.027200              | 0.044100              | 0.013900       |
| xv_timesegments_compute_delta * 34 segments                       | 11.051000      | 7.740000       | 7.920000              | 11.570000             | 4.740000       |
| xv_zonevistime_compute (6 zones) * 30 orbits 6 zones              | 44.900002      | 34.000000      | 55.000000             | 57.000000             | 41.000000      |
| xv_gen_scf * 27 segments  | 4.234000       | 1.570000       | 2.070000              | 2.640000              | 1.980000       |
| xv_station_compute * 10 orbits 7 stations                         | 166.300003     | 117.000000     | 174.000000            | 185.000000            | 120.000000     |
| xv_stationvistime_compute * 10 orbits                             | 41.200001      | 33.000000      | 51.000000             | 52.000000             | 39.000000      |

|   |            |            |            |            |            |
|---|------------|------------|------------|------------|------------|
| xv_star_vis_time * 100 orbits               | 335.200012 | 316.000000 | 505.000000 | 531.000000 | 355.000000 |
| xv_timesegments_compute_mapping * 50 orbits | 156.399994 | 139.000000 | 235.000000 | 254.000000 | 179.000000 |
| xv_orbit_extra                              | 20.020000  | 11.400000  | 16.799999  | 17.299999  | 7.400000   |
| xv_gen_swath                                | 321.470001 | 165.399994 | 240.500000 | 282.399994 | 168.199997 |
| xv_gen_swath_no_file                        | 229.149994 | 95.199997  | 126.099998 | 142.199997 | 77.000000  |
| xv_sc_vis_time * 10 orbits                  | 902.700012 | 491.000000 | 656.000000 | 708.000000 | 305.000000 |

Note that when the value “0.000000” is defined for a function in a certain platform, it means that its running time is lower than 1 nano-second and so it can be considered as “0”. LIBRARY PRECAUTIONS

The following precaution shall be taking into account when using EO\_VISIBILITY library:

- When a message like  
 <LIBRARY NAME> >>> ERROR in *xv\_function*: Internal computation error # *n*  
 or  
 <LIBRARY NAME> >>> WARNING in *xv\_function*: Internal computation warning # *n*  
 appears, run the program in **verbose** mode for a complete description of warnings and errors and call for maintenance if necessary.

## 9 KNOWN PROBLEMS

The following precautions shall be taken into account when using the CFI software libraries:

*Table 112: Known problems*

| CFI library     | Problem                     | Work around solution |
|-----------------|-----------------------------|----------------------|
| xv_gps_vis_time | Functions not available yet | -                    |