

# Earth Explorer Mission CFI Software

## EXPLORER\_VISIBILITY SOFTWARE USER MANUAL

**Code:** CS-MA-DMS-GS-0006  
**Issue:** 3.4  
**Date:** 18/11/05

	<b>Name</b>	<b>Function</b>	<b>Signature</b>
<b>Prepared by:</b>	José Antonio González Abeytua	Project Manager	
	Juan José Borrego Bote	Project Engineer	
<b>Checked by:</b>	José Antonio González Abeytua	Project Manager	
<b>Approved by:</b>	José Antonio González Abeytua	Project Manager	

DEIMOS Space S.L.  
Ronda de Poniente , 19, Tres Cantos  
28760 Madrid, SPAIN  
Tel.: +34 91 806 34 50  
Fax: +34 91 806 34 51  
E-mail: [deimos@deimos-space.com](mailto:deimos@deimos-space.com)

© DEIMOS Space S.L., 2005

All Rights Reserved. No part of this document may be reproduced, stored in a retrieval system, or transmitted, in any form or by any means, electronic, mechanical, photocopying, recording or otherwise, without the prior written permission of DEIMOS Space S.L. or ESA.

## Document Information

Contract Data		Classification	
Contract Number:	15583/01/NL/GS	Internal	<input type="checkbox"/>
		Public	<input type="checkbox"/>
Contract Issuer:	ESA / ESTEC	Industry	<input checked="" type="checkbox"/>
		Confidential	<input type="checkbox"/>

External Distribution		
Name	Organisation	Copies

Electronic handling	
Word Processor:	Adobe Framemaker 6.0
Archive Code:	P/SUM/DMS/01/026-029
Electronic file name:	cs-ma-dms-gs-0006-21

## Document Status Log

Issue	Change Description	Date	Approval
1.0	Unreleased	19/06/02	
2.0	Complete document	29/11/02	
2.1	Maintenance release with the following main changes: <ul style="list-style-type: none"> <li>• xv_multizones_vis_time added.</li> <li>• xv_multistation_vis_time added.</li> <li>• xv_time_segment_mapping added.</li> <li>• xv_orbit_extra added.</li> </ul> See change bars for complete document update.	13/05/03	
2.2	Maintenance release	30/09/03	
2.2.2	Small interface change in xv_time_segments_delta and xv_orbit_extra	26/04/04	
3.0	New initialisation strategy and interfaces.	21/07/04	
3.1	New features for xv_zone_vis_time function: <ul style="list-style-type: none"> <li>• Use of Predicted Orbit/Orbit event files.</li> <li>• Use of Swath Definition files.</li> </ul>	13/10/04	
3.2	Maintenance release	15/11/04	
3.3	New features: <ul style="list-style-type: none"> <li>• Use of Predicted Orbit/Orbit event files for all visibility functions.</li> <li>• Use of Swath Definition files for all visibility functions.</li> <li>• ENVISAT ASCII files are no longer supported</li> </ul>	11/07/05	
3.4	<ul style="list-style-type: none"> <li>• Maintenance release.</li> <li>• gen_swath executable moved to this library.</li> <li>• Changes in the xv_swath_pos interface</li> </ul>	18/11/05	

## Table of Contents

<b>1. SCOPE.....</b>	<b>11</b>
<b>2. ACRONYMS AND NOMENCLATURE .....</b>	<b>12</b>
2.1. Acronyms .....	12
2.2. Nomenclature .....	12
<b>3. APPLICABLE AND REFERENCE DOCUMENTS .....</b>	<b>13</b>
3.1. Applicable documents .....	13
3.2. Reference documents .....	13
<b>4. INTRODUCTION .....</b>	<b>14</b>
4.1. Functions Overview .....	14
4.2. Calling Sequence.....	15
<b>5. LIBRARY INSTALLATION.....</b>	<b>17</b>
<b>6. LIBRARY USAGE.....</b>	<b>18</b>
6.1. Usage hints .....	20
6.2. General enumerations.....	20
<b>7. CFI FUNCTIONS DESCRIPTION.....</b>	<b>22</b>
7.1. xv_zone_vis_time.....	23
7.1.1. Overview .....	23
7.1.2. Swath Definition.....	25
7.1.2.1. <i>Earth-observing Instruments Swath Definition</i> .....	25
7.1.2.2. <i>Limb-sounding Instruments Swath Definition</i> .....	26
7.1.2.3. <i>Limb-sounding Instruments Inertial Swath Definition</i> .....	27
7.1.2.4. <i>Swath Definition for Envisat</i> .....	27
7.1.3. Zone Borders and Projection .....	30
7.1.4. Zone Definition .....	30
7.1.5. Intersection Definition.....	32
7.1.6. Intersection Algorithm.....	33
7.1.6.1. <i>Intersection with a point swath</i> .....	33
7.1.6.2. <i>Intersection with a line swath</i> .....	33
7.1.7. Usage Hints .....	35
7.1.7.1. <i>Limb-sounding Instruments Intersection</i> .....	35
7.1.7.2. <i>Zone Coverage</i> .....	35
7.1.7.3. <i>Combined use of xv_swath_pos and the coverage flag</i> .....	35
7.1.8. Calling sequence.....	36
7.1.9. Input parameters .....	39
7.1.10. Output parameters .....	43
7.1.11. Warnings and errors .....	45
7.1.12. Runtime performances.....	49

7.2. xv_station_vis_time .....	50
7.2.1. Overview .....	50
7.2.2. Calling interface .....	51
7.2.3. Input parameters .....	54
7.2.4. Output parameters .....	57
7.2.5. Warnings and errors .....	59
7.2.6. Runtime performances.....	61
7.3. xv_drs_vis_time .....	62
7.3.1. Overview .....	62
7.3.2. Calling interface .....	64
7.3.3. Input parameters .....	66
7.3.4. Output parameters .....	68
7.3.5. Warnings and errors .....	70
7.3.6. Runtime performances.....	73
7.4. xv_swath_pos .....	74
7.4.1. Overview .....	74
7.4.2. Calling sequence xv_swath_pos.....	75
7.4.3. Input parameters xv_swath_pos .....	76
7.4.4. Output parameters xv_swath_pos.....	77
7.4.5. Warnings and errors .....	78
7.4.6. Runtime performances.....	80
7.5. xv_star_vis_time .....	81
7.5.1. Overview .....	81
7.5.2. Swath Definition.....	82
7.5.2.1. Inertial Swaths .....	82
7.5.2.2. Splitting swaths .....	83
7.5.2.3. Orbital Changes.....	83
7.5.3. Calling sequence xv_star_vis_time .....	84
7.5.4. Input parameters xv_star_vis_time.....	86
7.5.5. Output parameters xv_star_vis_time .....	88
7.5.6. Warnings and errors .....	90
7.5.7. Runtime performances.....	92
7.6. xv_multizones_vis_time.....	93
7.6.1. Overview .....	93
7.6.2. Calling sequence xv_multizones_vis_time .....	95
7.6.3. Input parameters xv_multizones_vis_time.....	97
7.6.4. Output parameters xv_multizones_vis_time .....	100
7.6.5. Warnings and errors .....	102
7.6.6. Runtime performances.....	103
7.7. xv_multistations_vis_time .....	104
7.7.1. Overview .....	104
7.7.2. Calling sequence xv_multistations_vis_time .....	106
7.7.3. Input parameters xv_multistations_vis_time.....	109
7.7.4. Output parameters xv_multistations_vis_time .....	111
7.7.5. Warnings and errors .....	113

---

7.7.6. Runtime performances.....	114
7.8. xv_orbit_extra .....	115
7.8.1. Overview .....	115
7.8.2. Calling sequence xv_orbit_extra .....	116
7.8.3. Input parameters xv_orbit_extra.....	117
7.8.4. Output parameters xv_orbit_extra.....	118
7.8.5. Warnings and errors .....	119
7.8.6. Runtime performances.....	119
7.9. xv_gps_vis_time.....	120
7.10. xv_time_segments_not.....	121
7.10.1. Overview .....	121
7.10.2. Calling sequence xv_time_segments_not.....	122
7.10.3. Input parameters xv_time_segments_not.....	124
7.10.4. Output parameters xv_time_segments_not .....	125
7.10.5. Warnings and errors .....	126
7.10.6. Runtime performances.....	127
7.11. xv_time_segments_or.....	128
7.11.1. Overview .....	128
7.11.2. Calling sequence xv_time_segments_or .....	129
7.11.3. Input parameters xv_time_segments_or.....	132
7.11.4. Output parameters xv_time_segments_or .....	134
7.11.5. Warnings and errors .....	135
7.11.6. Runtime performances.....	136
7.12. xv_time_segments_and .....	137
7.12.1. Overview .....	137
7.12.2. Calling sequence xv_time_segments_and.....	138
7.12.3. Input parameters xv_time_segments_and .....	141
7.12.4. Output parameters xv_time_segments_and.....	143
7.12.5. Warnings and errors .....	144
7.12.6. Runtime performances.....	145
7.13. xv_time_segments_sort .....	146
7.13.1. Overview .....	146
7.13.2. Calling sequence xv_time_segments_sort.....	147
7.13.3. Input parameters xv_time_segments_sort .....	149
7.13.4. Output parameters xv_time_segments_sort .....	150
7.13.5. Warnings and errors .....	151
7.13.6. Runtime performances.....	152
7.14. xv_time_segments_merge .....	153
7.14.1. Overview .....	153
7.14.2. Calling sequence xv_time_segments_merge.....	154
7.14.3. Input parameters xv_time_segments_merge .....	156
7.14.4. Output parameters xv_time_segments_merge .....	158
7.14.5. Warnings and errors .....	159
7.14.6. Runtime performances.....	160
7.15. xv_time_segments_delta .....	161

---

7.15.1. Overview .....	161
7.15.2. Calling sequence xv_time_segments_delta .....	162
7.15.3. Input parameters xv_time_segments_delta .....	164
7.15.4. Output parameters xv_time_segments_delta.....	166
7.15.5. Warnings and errors .....	167
7.15.6. Runtime performances.....	168
<b>7.16. xv_time_segments_mapping .....</b>	<b>169</b>
7.16.1. Overview .....	169
7.16.2. Calling sequence xv_time_segments_mapping.....	171
7.16.3. Input parameters xv_time_segments_mapping .....	174
7.16.4. Output parameters xv_time_segments_mapping .....	177
7.16.5. Warnings and errors .....	179
7.16.6. Runtime performances.....	181
<b>7.17. xv_gen_swath.....</b>	<b>182</b>
7.17.1. Overview .....	182
7.17.2. Calling interface .....	182
7.17.3. Input parameters .....	183
7.17.4. Output parameters .....	185
7.17.5. Warnings and errors .....	186
7.17.6. Runtime performances.....	186
7.17.7. Executable Program.....	187
<b>8. LIBRARY PRECAUTIONS.....</b>	<b>188</b>
<b>9. KNOWN PROBLEMS.....</b>	<b>189</b>

## List of Tables

Table 1:	CFI functions included within EXPLORER_VISIBILITY library .....	19
Table 2:	Some enumerations within EXPLORER_VISIBILITY library .....	20
Table 3:	Envisat Swaths .....	28
Table 4:	Zone definition.....	30
Table 5:	Input parameters of xv_zone_vis_time function .....	39
Table 6:	Output parameters of xv_zone_vis_time function.....	43
Table 7:	Runtime performances of xv_zone_vis_time function .....	49
Table 8:	Input parameters of xv_station_vis_time.....	54
Table 9:	Output parameters of xv_station_vis_time function.....	57
Table 10:	Runtime performances of xv_station_vis_time function.....	61
Table 11:	Assumptions for the start-up and stop trajectory computations .....	63
Table 12:	Input parameters of xv_drs_vis_time .....	66
Table 13:	Output parameters of xv_drs_vis_time function .....	68
Table 14:	Runtime performances of xv_drs_vis_time function.....	73
Table 15:	Input parameters of xv_swath_pos .....	76
Table 16:	Output parameters of xv_swath_pos.....	77
Table 17:	Runtime performances of xv_swath_pos function .....	80
Table 18:	Input parameters of xv_star_vis_time.....	86
Table 19:	Output Parameters of xv_star_vis_time.....	88
Table 20:	Runtime performances of xv_swath_pos function .....	92
Table 21:	Input parameters of xv_multizones_vis_time.....	97
Table 22:	Output parameters of xv_multizones_vis_time .....	100
Table 23:	Runtime performances of xv_multizones_vis_time function.....	103
Table 24:	Input parameters of xv_multistations_vis_time.....	109
Table 25:	Output parameters of xv_multistations_vis_time .....	111
Table 26:	Runtime performances of xv_multistations_vis_time function.....	114
Table 27:	Input parameters of xv_orbit_extra.....	117
Table 28:	Output parameters of xv_orbi_extra .....	118
Table 29:	Runtime performances of xv_orbit_extra function.....	119
Table 30:	Input parameters of xv_time_segments_not .....	124
Table 31:	Output parameters of xv_time_segments_not .....	125
Table 32:	Runtime performances of xv_time_segments_not function .....	127
Table 33:	Input parameters of xv_time_segments_or.....	132
Table 34:	Output parameters of xv_time_segments_or .....	134
Table 35:	Runtime performances of xv_time_segments_or function.....	136
Table 36:	Input parameters of xv_time_segments_and .....	141
Table 37:	Output parameters of xv_time_segments_and.....	143



---

Table 38:	Runtime performances of xv_time_segments_and function .....	145
Table 39:	xv_time_segments_sort function .....	146
Table 40:	Input parameters of xv_time_segments_sort .....	149
Table 41:	Output parameters of xv_time_segments_sort .....	150
Table 42:	Runtime performances of xv_time_segments_sort function .....	152
Table 43:	Input parameters of xv_time_segments_merge .....	156
Table 44:	Output parameters of xv_time_segments_merge.....	158
Table 45:	Runtime performances of xv_time_segments_merge function .....	160
Table 46:	Input parameters of xv_time_segments_delta .....	164
Table 47:	Output parameters of xv_time_segments_delta.....	166
Table 48:	Runtime performances of xv_time_segments_delta function .....	168
Table 49:	Input parameters of xv_time_segments_mapping .....	174
Table 50:	Output parameters of xv_time_segments_mapping .....	177
Table 51:	Runtime performances of xv_time_segments_mapping function .....	181
Table 52:	Input parameters of xv_gen_swath function.....	183
Table 53:	Output parameters of xv_gen_swath function .....	185
Table 54:	Error messages of xv_gen_swath function .....	186
Table 55:	Runtime performances of xv_gen_swath function .....	186
Table 56:	Known problems.....	189

---

## List of Figures

Figure 1:	EXPLORER_VISIBILITY Data Flow	16
Figure 2:	Segment Definition xv_zone_vis_time	23
Figure 3:	Earth-observing instrument: swath definition	25
Figure 4:	Limb-sounding instrument: swath definition (1)	26
Figure 5:	Limb-sounding instrument: swath definition (2)	27
Figure 6:	Zone examples	31
Figure 7:	Intersection examples	32
Figure 8:	Swath points	34
Figure 9:	swath coverage definition	35
Figure 10:	Two tangent altitudes over the ellipsoid	82
Figure 11:	Instantaneous FOV projected on the celestial sphere	83
Figure 12:	xv_multizones_vis_time function	93
Figure 13:	xv_time_segments_not function	121
Figure 14:	xv_time_segments_or function	128
Figure 15:	xv_time_segments_and function	137
Figure 16:	xv_time_segments_merge function	153
Figure 17:	Different mappings with common segments	169

## 1 SCOPE

The EXPLORER\_VISIBILITY Software User Manual provides a detailed description of usage of the CFI functions included within the EXPLORER\_VISIBILITY CFI software library.

---

## 2 ACRONYMS AND NOMENCLATURE

### 2.1 Acronyms

ANX	Ascending Node Crossing
AOCS	Attitude and Orbit Control Subsystem
CFI	Customer Furnished Item
EF	Earth Fixed reference frame
ESA	European Space Agency
ESTEC	European Space Technology and Research Centre
FOS	Flight Operations Segment
GS	Ground Station
OSF	Orbit Scenario File
SSP	Sub-Satellite Point
SRAR	Satellite Relative Actual Reference
SUM	Software User Manual
TOD	True of Date reference frame
UTC	Universal Time Coordinated
UT1	Universal Time UT1
WGS[84]	World Geodetic System 1984

### 2.2 Nomenclature

CFI	A group of CFI functions, and related software and documentation. that will be distributed by ESA to the users as an independent unit
CFI function	A single function within a CFI that can be called by the user
Library	A software library containing all the CFI functions included within a CFI plus the supporting functions used by those CFI functions (transparently to the user)

---

## 3 APPLICABLE AND REFERENCE DOCUMENTS

### 3.1 Applicable documents

[GEN\_SUM] Earth Explorer Mission CFI Software. General Software User Manual. CS-MA-DMS-GS-0002. Issue 3.4. 18/11/05

### 3.2 Reference documents

[MCD] Earth Explorer Mission CFI Software. Mission Conventions Document. CS-MA-DMS-GS-0001. Issue 1.3 15/07/03.

[F\_H\_SUM] Earth Explorer Mission CFI Software. EXPLORER\_FILE\_HANDLING Software User Manual. CS-MA-DMS-GS-0008. Issue 3.4. 18/11/05

[LIB\_SUM] Earth Explorer Mission CFI Software. EXPLORER\_LIB Software User Manual. CS-MA-DMS-GS-0003. Issue 3.4. 18/11/05

[ORBIT\_SUM] Earth Explorer Mission CFI Software. EXPLORER\_ORBIT Software User Manual. CS-MA-DMS-GS-0004. Issue 3.4. 18/11/05

[POINT\_SUM] Earth Explorer Mission CFI Software. EXPLORER\_POINTING Software User Manual. CS-MA-DMS-GS-0005. Issue 3.4. 18/11/05

[DAT\_SUM] Earth Explorer Mission CFI Software. EXPLORER\_DATA\_HANDLING Software User Manual. CS-MA-DMS-GS-0009 Issue 3.4. 18/11/05

[FORMATS] Earth Explorer File Format Guidelines. CS-TN-ESA-GS-0148.

## 4 INTRODUCTION

### 4.1 Functions Overview

This software library contains the CFI functions required to compute time segments at which an Earth Explorer satellite, or one of its instruments is in view of various targets:

- zones (defined as polygons or circles, on the earth ellipsoid or at a given altitude)
- ground stations
- data relay satellites
- stars

This library is to be used for planning of Earth Explorer operations.

It includes, the following CFI functions:

- **xv\_station\_vis\_time**: computes visibility time segments for a ground station
- **xv\_drs\_vis\_time**: computes visibility time segments for a data relay satellite
- **xv\_zone\_vis\_time**: computes visibility time segments for an instrument swath in visibility of a zone.
- **xv\_swath\_pos**: computes location of a swath at a given time (additional routine to help refine the results of **xv\_zone\_vis\_time**)
- **xv\_star\_vis\_time**: computes visibility time segments for a star.
- **xv\_multizones\_vis\_time**: computes the visibility segments of several zones and sort them to different criteria.
- **xv\_multistations\_vis\_time**: computes the visibility segments of several ground stations and sort them according to different criteria.
- **xv\_gps\_vis\_time**: computes visibility time segments for a gps constellation.
- **xv\_gen\_swath** generates the instrument swath template file for a given satellite, instrument mode and orbit.
- **Time Segments Manipulation Routines**:
  - **xv\_time\_segments\_not**: returns the complement of 1 vector of time segments.
  - **xv\_time\_segments\_and**: returns the intersection segments from 2 vectors of time segments.
  - **xv\_time\_segments\_or**: returns the joined segments from 2 vectors of time segments
  - **xv\_time\_segments\_delta**: add or subtract time durations at the beginning and end of each time segment in a vector.
  - **xv\_time\_segments\_sort**: returns the vector of time segments sorted according to absolute or relative orbits.
  - **xv\_time\_segments\_merge**: merges all the overlapped segments in a list.
  - **xv\_time\_segments\_mapping**: returns a subset of the time segments vector, such that this subset covers entirely a zone or line swath.

Several files are required to operate properly the above functions:

- Orbit Scenario File (all functions)

- Swath Template Files (**xv\_station\_vis\_time**, **xv\_zone\_vis\_time**, **xv\_swath\_pos**)
- Ground Stations Database File (**xv\_station\_vis\_time**)
- (optionally) Zones Database File (**xv\_zone\_vis\_time**)
- (optionally) Star Database File (**xv\_star\_vis\_time**)

Note that all the above routines use orbit-relative time parameters (i.e. the time parameters are represented as orbit number + time since ascending node). Two functions from EXPLORER ORBIT will be very useful to process the input/outputs:

- **xo\_time\_to\_orbit**: converts from TAI/UTC/UT1 time to orbit-relative time
- **xo\_orbit\_to\_time**: converts from orbit-relative time to TAI/UTC/UT1 time

## 4.2 Calling Sequence

An overview of the data flow is presented in Figure 1.

Figure 1 EXPLORER\_VISIBILITY Data Flow

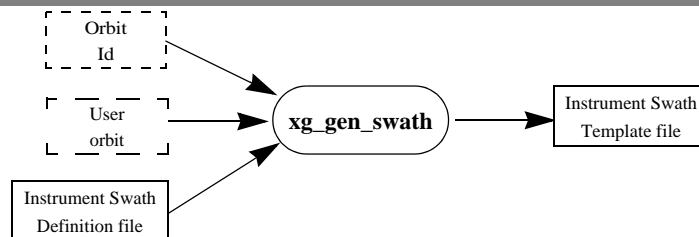
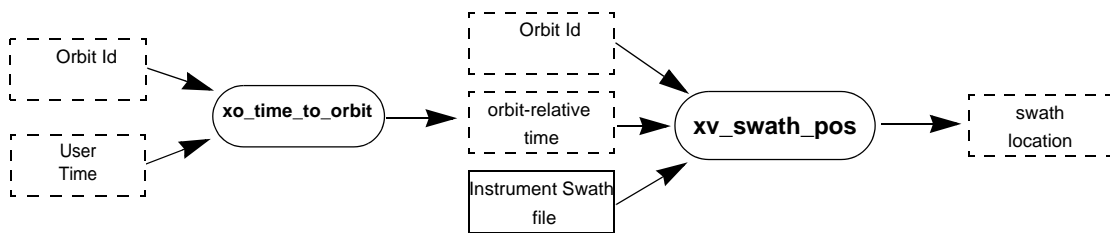
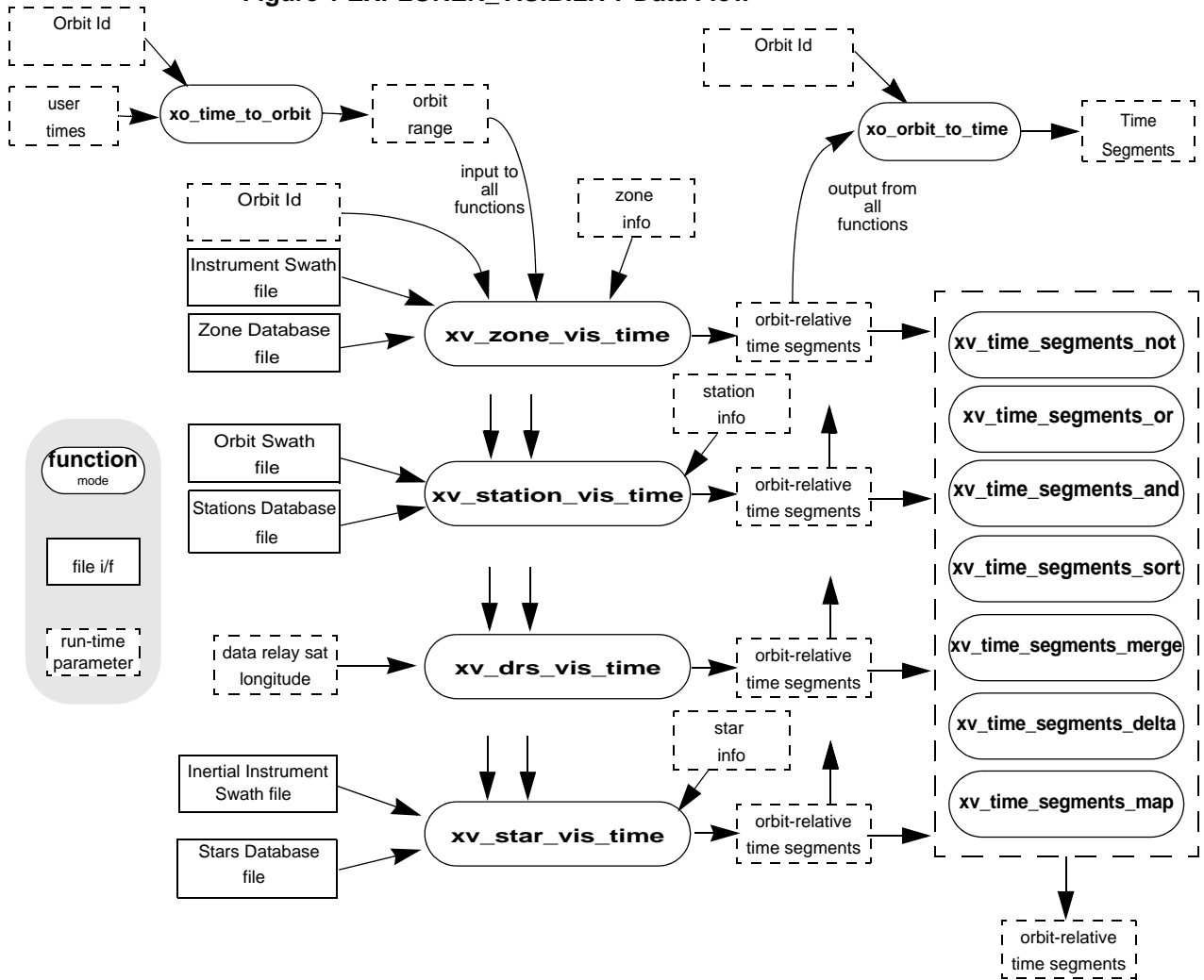



## 5 LIBRARY INSTALLATION

For a detailed description of the installation of any CFI library, please refer to [GEN\_SUM].

Note that example data files are provided with this CFI.

.

## 6 LIBRARY USAGE

Note that to use the EXPLORER\_VISIBILITY software library, the following other CFI software libraries are required:

- EXPLORER\_FILE\_HANDLING (See [F\_H\_SUM]).
- EXPLORER\_DATA\_HANDLING (See [DAT\_SUM]).
- EXPLORER\_LIB (See [F\_H\_SUM]).
- EXPLORER\_ORBIT (See [ORBIT\_SUM]).
- EXPLORER\_POINTING (See [POINT\_SUM]).

It is also needed to have properly installed in the system the following external GPL library:

- LIBXML2 (See [GEN\_SUM]).

To use the EXPLORER\_VISIBILITY software library in a user application, that application must include in his source code either:

- `explorer_visibility.h` (for a C application)
- `explorer_visibility.inc` (for a ForTran application under SOLARIS/Linux)
- `explorer_visibility.inc` (for a ForTran application under Windows 95/98/NT/2000)

To link correctly his application, the user must include in his linking command flags like (assuming `cfi_libs_dir` and `cfi_include_dir` are the directories where respectively all CFI libraries and include files have been installed, see [GEN\_SUM] for installation procedures):

- SOLARIS/LINUX:

```
-Icfi_include_dir -Lcfi_lib_dir -lexplorer_visibility
-lexplorer_pointing -lexplorer_orbit -lexplorer_lib
-lexplorer_data_handling -lexplorer_file_handling -lxml2
```

- Windows users:

```
/I "cfi_include_dir" /libpath:"cfi_lib_dir"
libexplorer_visibility.lib
libexplorer_pointing.lib
libexplorer_orbit.lib
libexplorer_lib.lib
libexplorer_data_handling.lib
libexplorer_file_handling.lib
libxml2.lib
```

- MacOS:

```
-Icfi_include_dir -Lcfi_lib_dir -lexplorer_visibility
-lexplorer_pointing -lexplorer_orbit -lexplorer_lib
-lexplorer_data_handling -lexplorer_file_handling
-framework libxml -framework libiconv
```

All functions described in this document have a name starting with the prefix `xv_`.

To avoid problems in linking a user application with the EXPLORER\_VISIBILITY software library due to the existence of names multiple defined, the user application should avoid naming any global software item beginning with either the prefix XV\_ or xv\_.

This is summarized in table 1.

*Table 1: CFI functions included within EXPLORER\_VISIBILITY library*

Function Name	Enumeration value	long
<b>Main CFI Functions</b>		
xv_zone_vis_time	XV_ZONE_VIS_TIME_ID	0
xv_station_vis_time	XV_STATION_VIS_TIME_ID	1
xv_drs_vis_time	XV_DRS_VIS_TIME_ID	2
xv_swath_pos_id	XV_SWATH_POS_ID	3
xv_star_vis_time	XV_STAR_VIS_TIME_ID	4
xv_multizones_vis_time	XV_MULTIZONES_VIS_TIME_ID	5
xv_multistations_vis_time	XV_MULTISTATIONS_VIS_TIME_ID	6
xv_time_segments_not	XV_TIME_SEGMENTS_NOT_ID	7
xv_time_segments_or	XV_TIME_SEGMENTS_OR_ID	8
xv_time_segments_and	XV_TIME_SEGMENTS_AND_ID	9
xv_time_segments_sort	XV_TIME_SEGMENTS_SORT_ID	10
xv_time_segments_merge	XV_TIME_SEGMENTS_MERGE_ID	11
xv_time_segments_delta	XV_TIME_SEGMENTS_DELTA_ID	12
xv_time_segments_mapping	XV_TIME_SEGMENTS_MAPPING_ID	13
xv_orbit_extra	XV_ORBIT_EXTRA_ID	14
xv_gen_swath	XV_GEN_SWATH_ID	15
<b>Error Handling Functions</b>		
xv_verbose	not applicable	
xv_silent		
xv_get_code		
xv_get_msg		
xv_print_msg		

Notes about the table:

- To transform the status vector returned by a CFI function to either a list of error codes or list of error messages, the enumeration value (or the corresponding integer value) described in the table must be used.
- The error handling functions have no enumerated value.

## 6.1 Usage hints

Every CFI function has a different length of the Error Vector, used in the calling I/F examples of this SUM and defined at the beginning of the library header file. In order to provide the user with a single value that could be used as Error Vector length for every function, a generic value has been defined (XV\_ERR\_VECTOR\_MAX\_LENGTH) as the maximum of all the Error Vector lengths. This value can therefore be safely used for every call of functions of this library.

## 6.2 General enumerations

The aim of the current section is to present the enumeration values that can be used rather than integer parameters for some of the input parameters of the EXPLORER\_VISIBILITY routines, as shown in the table below. The enumerations presented in [GEN\_SUM] are also applicable.

*Table 2: Some enumerations within EXPLORER\_VISIBILITY library*

Input	Description	Enumeration value	Long
Orbit type / Order Criteria	Absolute Orbit	XV_ORBIT_ABS	0
	Relative Orbit	XV_ORBIT_REL	1
Projections	Projection from DB file	XV_READ_DB	0
	Gnomonic projection	XV_GNOMONIC	1
	Rectangular projection	XV_RECTANGULAR	2
zone_vis_time cover- age outputs	Zone completely covered by swath	XV_COMPLETE	0
	Left extreme transition found by ZONE_VIS_TIME	XV_LEFT	1
	Right extreme transition found by ZONE_VIS_TIME	XV_RIGHT	2
	Both extreme transition found by ZONE_VIS_TIME	XV_BOTH	3
stat_vis_time mask inputs	AOS, LOS and physical masks	XV_COMBINE	0
	AOS, LOS masks	XV_AOS_LOS	1
	Physical mask only	XV_PHYSICAL	2
star_vis_time cover- age outputs	Visibility stars/ends at the first/last FOV in star_vis_time	XV_STAR_UNDEFINED	0
	Visibility stars/ends at the upper FOV in star_vis_time	XV_STAR_UPPER	1
	Visibility stars/ends at the lower FOV in star_vis_time	XV_STAR_LOWER	2
	Visibility stars/ends at the left FOV in star_vis_time	XV_STAR_LEFT	3

*Table 2: Some enumerations within EXPLORER\_VISIBILITY library*

Input	Description	Enumeration value	Long
	Visibility starts/ends at the right FOV in star_vis_time	XV_STAR_RIGHT	4
Order enumeration	Input Segments ordered by start time	XV_TIME_ORDER	0
	Input Segments not ordered by start time	XV_NO_TIME_ORDER	1
Segments direction	Ascending segment	XV_ASCENDING	0
	Descending segment	XV_DESCENDING	1
Swath flag	Swath Template File	XV_STF	0
	Swath Definition File	XV_SDF	1

The use of the previous enumeration values could be restricted by the particular usage within the different CFI functions. The actual range to be used is indicated within a dedicated reference named **allowed range**. When there are not restrictions to be mentioned, the allowed range column is populated with the label **complete**.

---

## 7 CFI FUNCTIONS DESCRIPTION

The following sections describe each CFI function.

The calling interfaces are described both for C users and ForTran users.

Input and output parameters of each CFI function are described in tables, where C programming language syntax is used to specify:

- Parameter types (e.g. long, double)
- Array sizes of N elements (e.g. param[N])
- Array element M (e.g. [M])

ForTran users should adapt the tables using ForTran syntax equivalent terms:

- Parameter types (e.g. long  $\Leftrightarrow$  INTEGER\*4, double  $\Leftrightarrow$  REAL\*8)
- Array sizes of N elements (e.g. param[N]  $\Leftrightarrow$  param (N))
- Array element M (e.g. [M]  $\Leftrightarrow$  (M+1))

## 7.1 xv\_zone\_vis\_time

### 7.1.1 Overview

The **xv\_zone\_vis\_time** function computes all the orbital segments for which a given instrument swath intercepts a user-defined zone at the surface of the Earth ellipsoid.

An orbital segment is a time interval along the orbit, defined by start and stop times expressed as seconds (and microseconds) elapsed since the ascending node crossing.

A user-defined zone can be:

- a polygon specified by a set of latitude and longitude points
- a circle specified by the centre latitude, longitude, and the diameter

Note that particular cases of the above can be used to define the zone as:

- a point
- a line

Figure 2 Segment Definition xv\_zone\_vis\_time

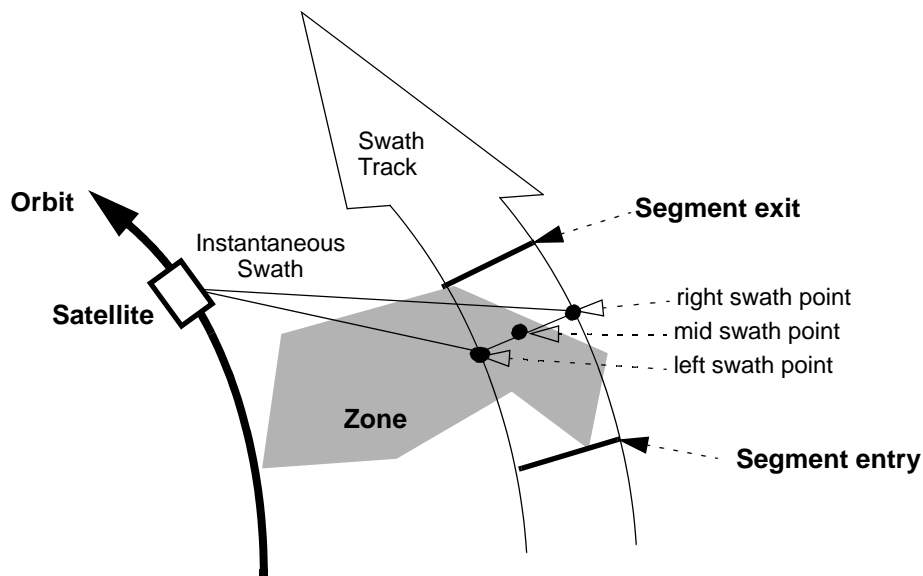

**xv\_zone\_vis\_time** requires access to several data structures and files to produce its results:

- the orbit\_id (xo\_orbit\_id) providing the orbital data. The orbit\_id can be initialized with the following data or files (see [ORBIT\_SUM]):
  - data for an orbital change
  - Orbit scenario files
  - Predicted orbit files
  - Orbit Event Files
  - Restituted orbit files
  - DORIS Preliminary orbit files
  - DORIS Navigator files

- the Instrument Swath File, excluding inertial swath files, describing the area seen by the relevant instrument all along the current orbit. The Swath data can be provided by:
  - A swath template file produced off-line by the EXPLORER\_VISIBILITY library (**xv\_gen\_swath** function).
  - A swath definition file, describing the swath geometry. In this case the **xv\_zone\_vis\_time** generates the swath points for a number of orbits given by the user.
- optionally, a Zone Database File, containing the zone description. The user can either specify a zone identifier referring to a zone in the file, or provide the zone parameters directly to **xv\_zone\_vis\_time**.

The time intervals used by **xv\_zone\_vis\_time** are expressed in absolute orbit numbers or in relative orbit and cycle numbers. This is valid for both:

- input parameter “Orbit Range”: first and last orbit to be considered. In case of using relative orbits, the corresponding cycle number should be used, otherwise, this the cycle number will be a dummy parameter.
- output parameter “Zone Visibility Segments”: time segments with time expressed as {absolute orbit number (or relative orbit number and cycle number), number of seconds since ascending node, number of microseconds }

The orbit representation (absolute or relative) for the output segments will be the same as in the input orbits. Moreover, the segments will be ordered chronologically.

Users who need to use processing times must make use of the conversion routines provided in EXPLORER\_ORBIT (**xo\_time\_to\_orbit** and **xo\_orbit\_to\_time** functions).

**NOTE:** Since the swath template file is generated from a reference orbit, it is not recommended to use **xv\_zone\_vis\_time** for a range of orbits that includes an orbital change (e.g. change in the repeat cycle or cycle length). If this would happen, **xv\_zone\_vis\_time** automatically will ignore those orbits that do not correspond with the template file (i.e. no visibility segments will be generated for those orbits).



## 7.1.2 Swath Definition

The swath file is generated using the `xv_gen_swath` function, within the `EXPLORER_VISIBILITY` library. There are 3 different types of swaths:

- earth-observing instruments ('nadir line' or 'nadir point')
- limb-sounding instruments ('limb', narrow or wide)
- limb-sounding instruments observing inertial objects ('inertial')

The following sub-sections provide some details on the various swath definitions.

### 7.1.2.1 Earth-observing Instruments Swath Definition

The term swath must be clearly defined to understand the explanations in this document:

- instantaneous swath: the part of the earth surface observed by an instrument at a given time
- swath track: represents the track made on the earth surface by the instantaneous swath over a period of time

For instruments observing the surface of the earth, the instantaneous swath is constituted by the line (or by the point for an instrument) on the ground observed by the instrument at a given time. It is calculated taking the earth ellipsoid as a reference for the earth surface. The wider the field-of-view of the instrument, the wider the swath on the ground.

When the satellite moves over a period of time, this line (or point) defines a band (or line) on the earth surface. This constitutes the swath track.

See Figure 3 for an illustration of these definitions.

Note that the terms line or point are an idealized view of the instrument FOV, which usually have a thickness.

**Figure 3 Earth-observing instrument: swath definition**

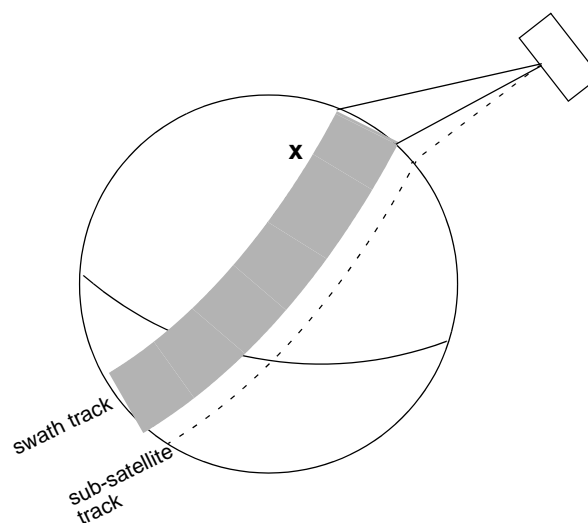

### 7.1.2.2 Limb-sounding Instruments Swath Definition

For limb sounding instruments, the concept can be generalized to define a “thick swath”. This is obtained by defining a minimum and a maximum altitude, and considering the tangent points to these altitudes as the edges of the swath. Two cases have to be considered:

- deterministic (narrow) azimuth field of view (e.g. MIPAS sideward-looking): the swath projection on the earth surface is similar to a regular sideward-looking swath, with the lower altitude defining the further swath edge and the higher altitude defining the closer swath edge. See Figure 4.
- non-deterministic (potentially wide) azimuth field of view (e.g. MIPAS rearward-looking): due to the potentially wide azimuth field of view, each altitude defines a swath projection on the earth surface. Depending on the altitude, these swaths are of different width across-track, and also at different distance from the satellite. See Figure 5.

For these, 2 Instrument Swath Files are provided:

- one at the highest altitude
- one at the lowest altitude

The user must handle both swath himself to determine his required visibility time segments.

**Figure 4 Limb-sounding instrument: swath definition (1)**

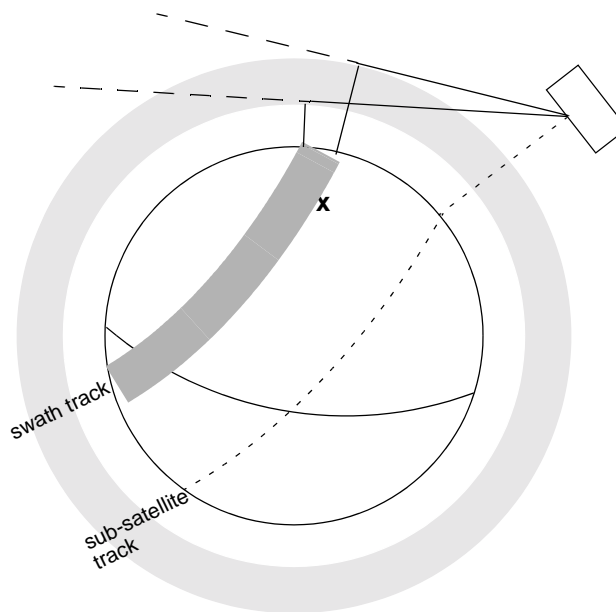

**Figure 5 Limb-sounding instrument: swath definition (2)**

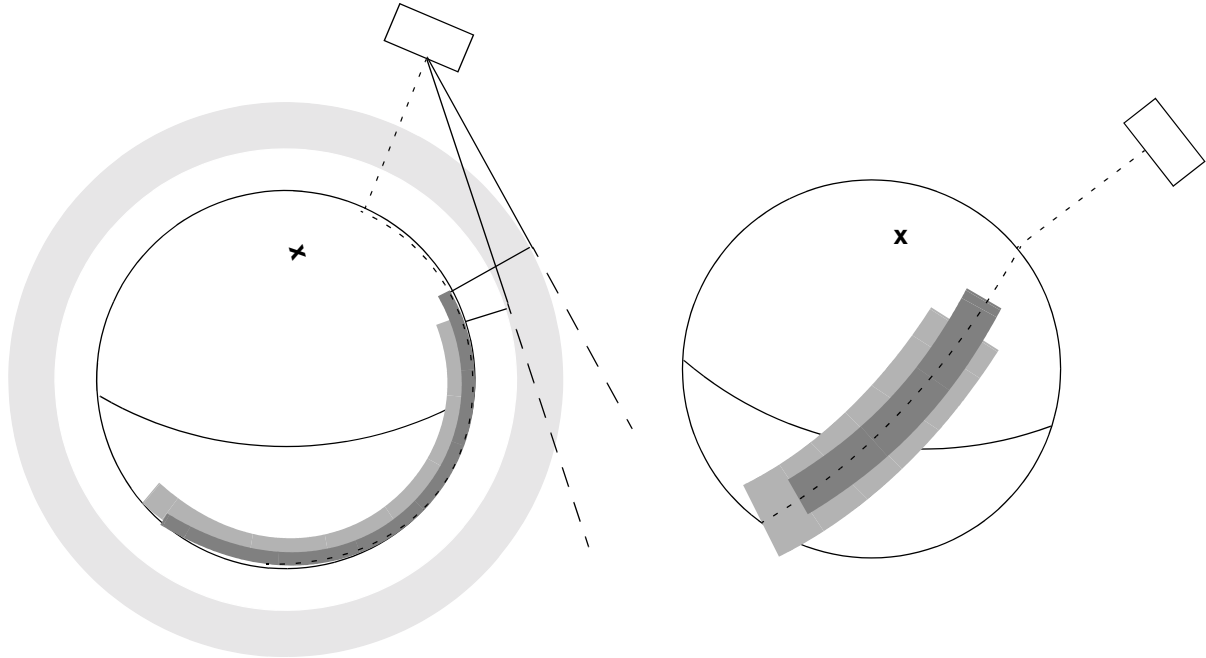

### **7.1.2.3 Limb-sounding Instruments Inertial Swath Definition**

This type corresponds to the observation of inertial targets (e.g. Gomos occultation mode and Mipas Line of Sight mode in Envisat). For the CFI function **xv\_star\_vis\_time** the FOV direction in inertial coordinates must be available. Therefore for these instrument modes the direction in inertial space, for a given tangent altitude, is given in the swath template file.

### **7.1.2.4 . Swath Definition for Envisat**

table 3 lists all instrument modes and the relevance of the swaths for Envisat-1. It shows also:

- the prefix to be used when generating the swath template file name
- the different types of algorithms to be used by xv\_gen\_swath (this is transparent to the user)

**Table 3: Envisat Swaths**

Instrument	Mode	File Prefix = swath	xv_gen_swath algorithm	Swath Type	Remarks
RA		RA_2__	POINT	Nadir point	Modeled as sub-satellite track
MERIS	Averaging / Direct & Averaging	MERIS_	LINE	Nadir line	
ASAR	Image Modes (IS1... IS7)	SARxIM (x=1...7)	ASAR	Nadir line	
	Alt. Polarization (IS1... IS7)				
	Wide Swath	SARWIM			
	Global Monitoring				
	Wave (IS1... IS7)	SARxWV (x=1...7)			Modeled as a continuous swath anywhere within the image swath
GOMOS	Occultation	GOMOIL GOMOIH	INERTIAL	Inertial direction	IFOV much smaller than swath. IFOV Very dependent on star availability. 2 swaths defined: - 1 for high altitude (GOMOIH) - 1 for low altitude (GOMOIL)
	Occultation	GOMO_H GOMO_L	LIMB	Limb wide	Same mode as above, now swath defined as Earth-fixed location. IFOV much smaller than swath. IFOV Very dependent on star availability. 2 swaths defined: - 1 for high altitude (GOMO_H) - 1 for low altitude (GOMO_L)
SCIAMACHY	Nadir / Nadir of Nadir & Limb	SCIAN_	LINE	Nadir line	Continuous Nadir swath modeled
	Limb / Limb of Nadir & Limb	SCIALH SCIALL		Limb wide	2 swaths defined: - 1 for high altitude (SCIALH) - 1 for low altitude (SCIALL)

**Table 3: Envisat Swaths**

Instrument	Mode	File Prefix = swath	xv_gen_swath algorithm	Swath Type	Remarks
AATSR		ATSR_N ATSR_F	LINE	Nadir line	2 swaths defined: - 1 for nadir swath - 1 for forward swath
MWR		MWR_	POINT	Nadir point	Modeled as sub-satellite track
MIPAS	Nominal	MIPN_H MIPN_L	LIMB	Limb narrow	2 swaths defined: - 1 for high altitude (MIPN_H) - 1 for low altitude (MIPN_L)
	Special Event Mode (across)	MIP_X_	LIMB	Limb narrow	Modeled as an across track swath, in the middle of the MIPAS SEM acquisition scan.
	Special Event Mode (rearward)	MIP_RH MIP_RL	LIMB	Limb wide	IFOV much smaller than swath. 2 swaths defined: - 1 for high altitude (MIP_RH) - 1 for low altitude (MIP_RL)
	Rearward  Sideward	MIPIRH MIPIRL  MIPIXH MIPIXL	INERTIAL	Inertial direction	2 swaths defined for rearward mode: - 1 for high altitude (MIPIRH) - 1 for low altitude (MIPIRL) 3 swaths defined for sideward mode: - 1 for high altitude (MIPIXH) - 1 for back mode (MIPIXB) - 1 for forward mode (MIPIXF)

### 7.1.3 Zone Borders and Projection

When defining a polygon zone, the user is assumed to wish polygon sides as straight lines. But on the earth surface, a straight line is, at best, a confusing concept.

The only way to define unambiguously straight lines is to work in a 2-dimensional projection of the earth surface. There are many possible projections, each having advantages and drawbacks.

**xv\_zone\_vis\_time** can handle zone borders in 2 different projections:

- rectangular projection, using longitude and latitude as the X and Y axis; this is appropriate to express zones where (some of) the edges follow constant latitude lines, and provide a reasonable approximation for straight lines at low-medium latitudes
- azimuthal gnomonic projection, where great circles are always projected as straight lines; this is better for high latitudes, where the rectangular projection suffers from too much distortion and the singularity at the poles.

**xv\_zone\_vis\_time** allows the user to specify which projection he wants to work in, i.e. in which projection the polygon sides will be represented by **xv\_zone\_vis\_time** as straight lines. The user is assumed to be aware of how the polygon sides behave on the Earth surface.

### 7.1.4 Zone Definition

The user-defined zone can be either (see table 4);

- a point
- a line
- a polygon
- a circle

A zone is defined by the area of the earth surface enclosed by the zone borders:

- in the case of a circular zone, the area inside the circle
- in the case of a polygonal zone, the area which is always to the right of any polygon side; if the polygon is defined as a sequence of N points, each polygon side is considered as a line from point i to point i+1; this unambiguously defines the right side of the polygon sides.

**Table 4: Zone definition**

Zone definition	Zone_num	Zone_long Zone_lat	Zone_diam	Description
Circular Zone	1	[0]: centre point	yes zone_diam > 0.0	The zone is represented as a circle, around the centre point
Point Zone	1	[0]: Point	yes zone_diam = 0.0	The zone is defined by the point. Resulting segments will have a zero duration. The zone will always be completely covered by the swath.
Line Zone	2	[0], [1]: Line	no	The zone is defined by the line from point [0] to point [1].
Polygon Zone	>2	[i]	no	The zone is defined by the area right of the line from point [i] to point [i+1].

For the gnomonic projection, a side of a zone is always smaller than a half great circle, because two polygon points are considered to be joined by the shortest line.

For the rectangular projection, two consecutive points of the zone are also joined by the shortest line; so the difference in longitude must be less than 180 degrees.

The polygon zone can be closed (i.e. the first and last points are the same) or not. If the zone is not closed, `xv_zone_vis_time` closes it by joining the last point with the first one in its internal computations.

See Figure 6 for examples of zone definitions.

`xv_zone_vis_time` will issue an error on the zone definition if the polygon has intersecting sides (“butterfly” zone)

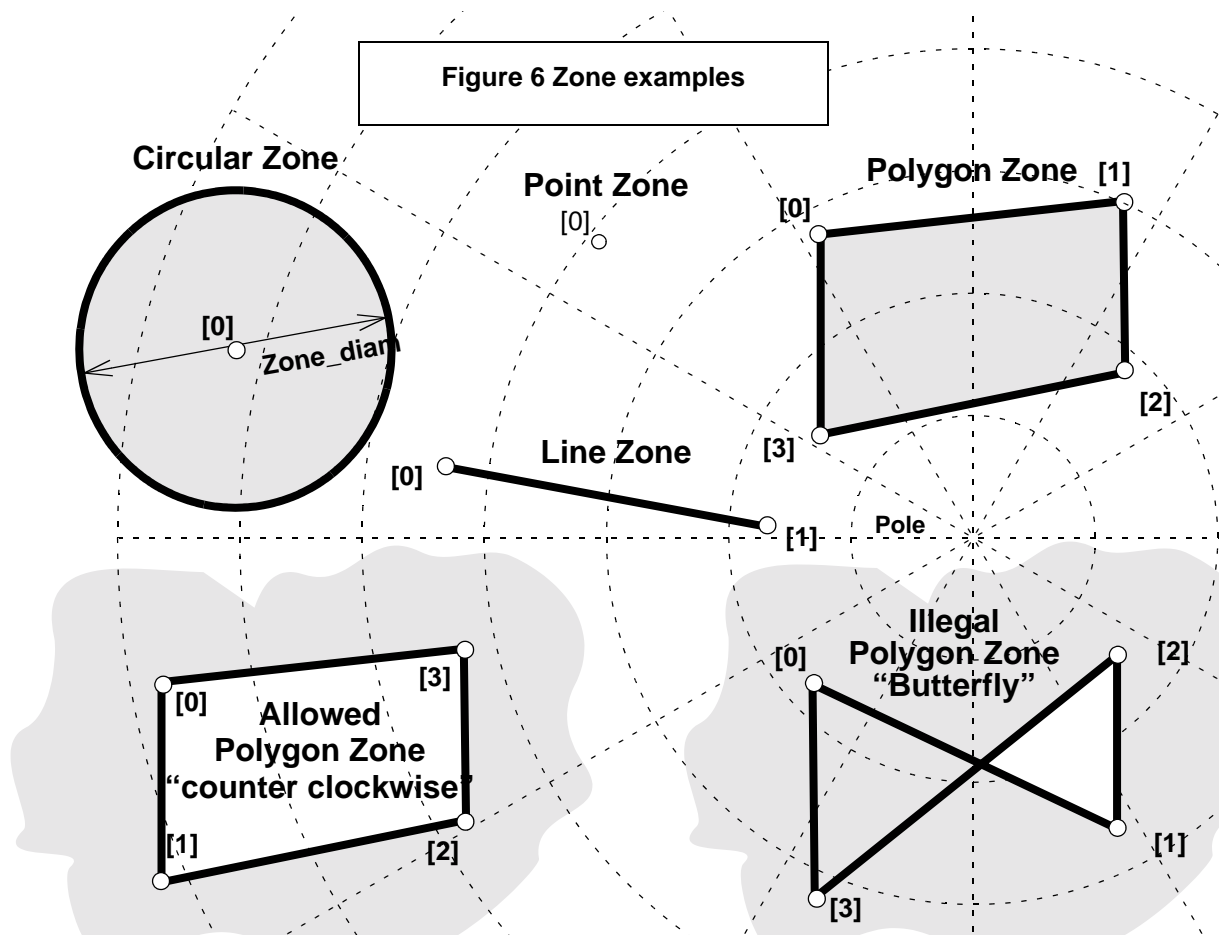

### 7.1.5 Intersection Definition

The **xv\_zone\_vis\_time** intersection times between the instrument swath and the user-defined zone are defined as the first and last occurrence, in chronological order with respect to the satellite direction, of the geometrical super-position of any point belonging to the instrument swath with any single point belonging to the zone (including the zone border).

The entry and exit times for each intersection are given as elapsed seconds (and microseconds) since the ascending node crossing.

Figure 7 shows some typical intersections.

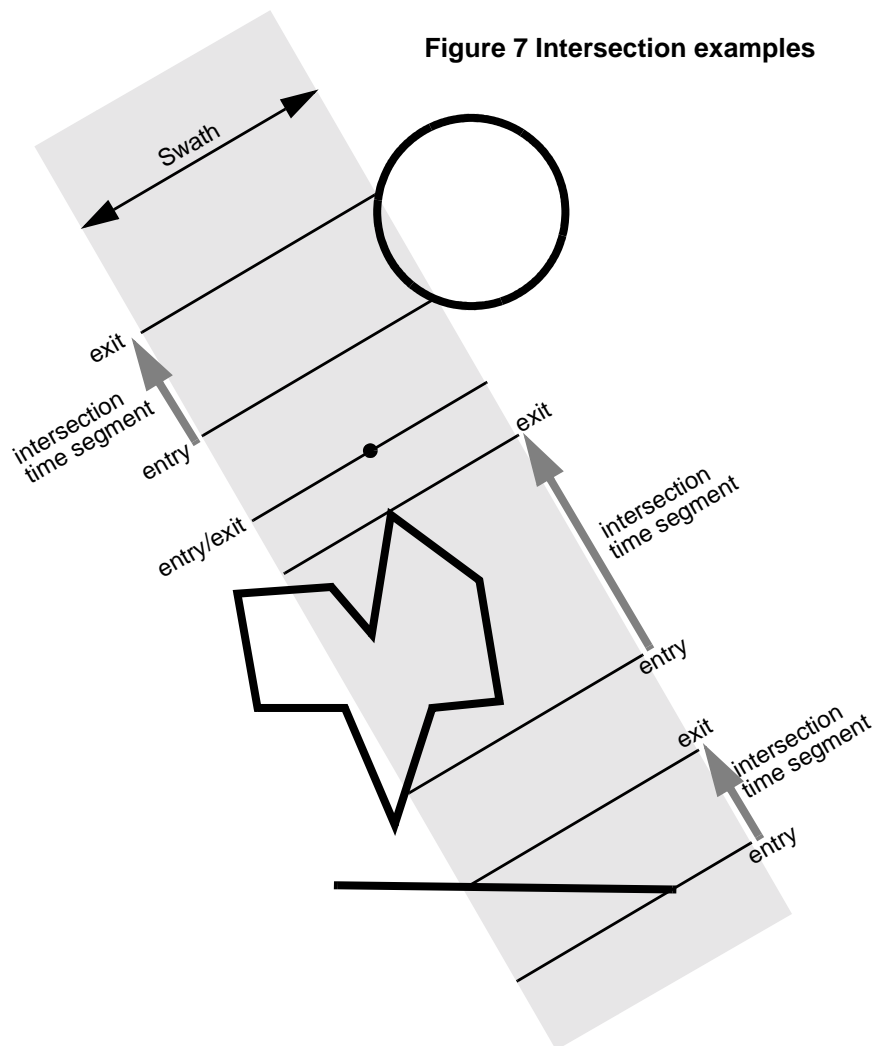



### 7.1.6 Intersection Algorithm

The intersection of a swath and a user-defined zone is to be performed on the Earth projected to a map plane in one of the following projections:

- Rectangular projection
- Gnomonic projection

Although the projections are quite different, the intersection rules are identical. The algorithm can however be different, in order to take advantage of a particular feature of a projection.

The purpose of the CFI function ZONEVISTIME is to obtain quickly, accurate intersection segments with a low precision (1 second).

The algorithms assume that the polygon zones are closed and expects a wrap around between the first and the last point. Thus ZONEVISTIME must first close the polygon if necessary.

For ZONEVISTIME the following swath types are defined:

- point swath: instantaneous swath is a point.
- line swath: instantaneous swath is a line.
- inertial swath: not used by ZONEVISTIME

The main concept in the algorithm is the transition, defined as the change in coverage of (part of) the swath and the zone (e.g. edge of the swath crosses one polygon side).

#### 7.1.6.1 Intersection with a point swath.

The vertices of the polygon defining the area are connected by straight lines in the chosen projection, along track swath points are also connected by straight lines in the same projection.

Transitions are located by linear intersection of the zone sides and the swath along track lines. A transition is only valid if the intersection occurs inside both line segments. The polygon side from  $\langle i \rangle$  to  $\langle j \rangle$  is defined in a clockwise manner inclusive point  $\langle i \rangle$  but exclusive point  $\langle j \rangle$ . The swath line from time  $\langle k \rangle$  to  $\langle l \rangle$  is defined inclusive the template point at  $\langle k \rangle$  but exclusive the template point at  $\langle l \rangle$ .

The fraction of the swath along track line determines the precise timing since time  $\langle k \rangle$  of the intersection. Also the determination if the transition is a on- or off-transition is quite trivial. First a vector is defined, perpendicular to the along track swath line, such that the vector points left. Then, the dot product of the polygon side and this vector is calculated. If the dot product is positive, the transition is on, i.e. the swath enters the zone. If the result is negative, then the swath leaves the zone. If the result equals zero then the transition can be ignored (polygon side and swath overlay, a proper transition will be found with another pair of polygon side - swath line.).

#### 7.1.6.2 Intersection with a line swath

The left, middle and right side of the swath, are located using the same algorithm as for the point swath. Even left, middle and right time segments can be made based on the left, middle and right hand transitions.

The polygon vertices (and not the sides) are intersected with the along track moving line swath, in order to catch zones smaller than the swath, etc. Swaths for intermediate times between two consecutive times in Swath Template File are considered straight segments, the first one joining an intermediate point of the Left swath line from time  $\langle k \rangle$  to time  $\langle l \rangle$ , with an intermediate point in Middle swath line, and the other segment joining this intermediate point in Middle swath line with an intermediate point in Right swath line.

Figure 8 Swath points

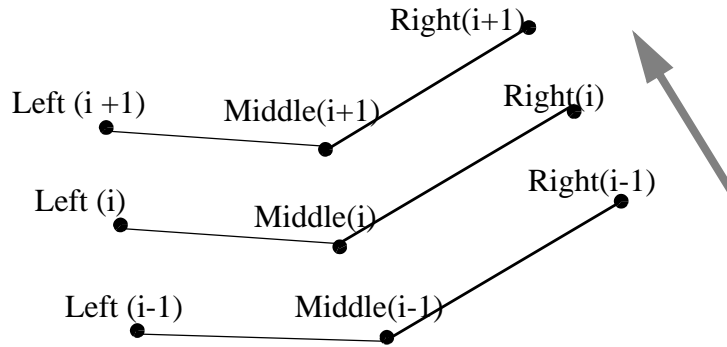

## 7.1.7 Usage Hints

### 7.1.7.1 Limb-sounding Instruments Intersection

In the case of limb-sounding instrument with a potentially wide azimuth field of view, 2 swaths have to be considered (1 for minimum altitude, 1 for maximum altitude). Furthermore, these 2 swaths are offset in time (i.e. their projection on the earth intersect with a given point at different times). To cope with this, the user must do the following:

- call `xv_zone_vis_time` twice (once for each extreme altitude swath)
- merge/filter the 2 sets of time segments, depending on what he wants to achieve

### 7.1.7.2 Zone Coverage

`xv_zone_vis_time` computes purely geometrical intersections. The resulting zone visibility segments might need some additional filtering by the user. In particular, instrument constraints (e.g. only working outside of sun eclipse) have to be considered by the user.

Furthermore, to help users to deal with zones wider than the swath (i.e. requiring several orbits to cover the whole zone), `xv_zone_vis_time` produces for each zone visibility segment an indication of the coverage type (see Figure 9);

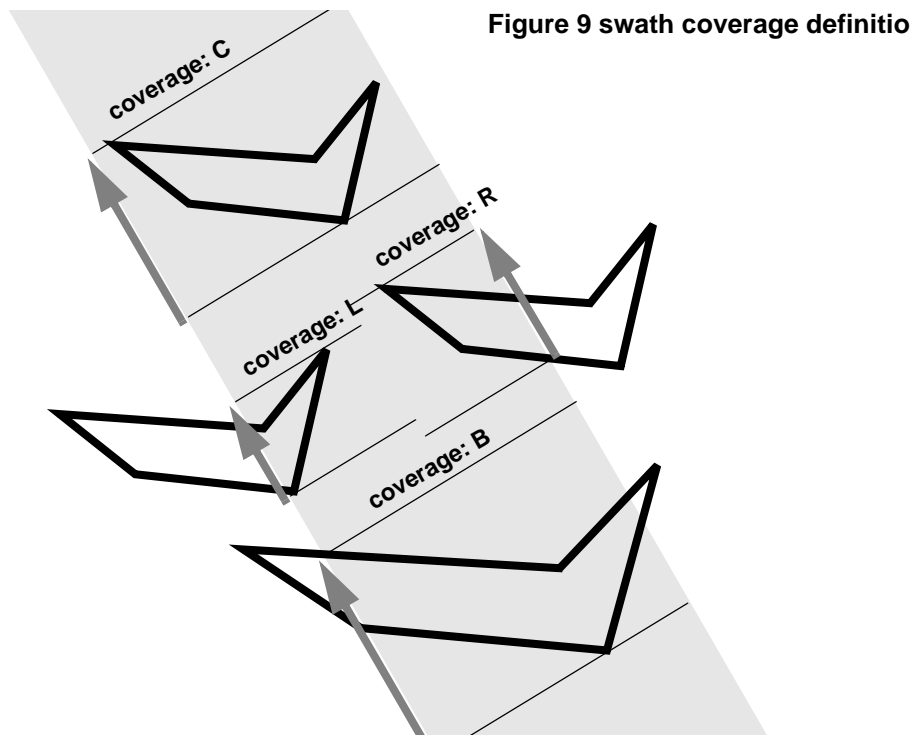

- coverage = C: zone completely covered by the swath
- coverage = R: zone partially covered by the swath, extending over the right edge of the swath
- coverage = L: zone partially covered by the swath, extending over the left edge of the swath
- coverage = B: zone partially covered by the swath, extending over both edges of the swath

### 7.1.7.3 Combined use of `xv_swath_pos` and the coverage flag

The `EXPLORER_VISIBILITY` function `xv_swath_pos` can be used to refine the work performed with `xv_zone_vis_time`.

### 7.1.8 Calling sequence

For C programs, the call to `xv_zone_vis_time` is (input parameters are underlined):

```
#include "explorer_visibility.h"
{
    xo_orbit_id orbit_id = {NULL};
    long        swath_flag, orbit_type,
               start_orbit, start_cycle,
               stop_orbit, stop_cycle,
               zone_num, projection,
               number_segments,
               *bgn_orbit, *bgn_second,
               *bgn_microsec, *bgn_cycle,
               *end_orbit, *end_second,
               *end_microsec, *end_cycle,
               *coverage, ierr[XV_NUM_ERR_ZONE_VIS_TIME],
               status;
    double      *zone_long, *zone_lat,
               zone_diam, min_duration;
    char        *swath_file;
    char        zone_id[8], *zone_db_file;

    status = xv_zone_vis_time(&orbit_id,
                             &orbit_type,
                             &start_orbit, &start_cycle,
                             &stop_orbit, &stop_cycle,
                             &swath_flag, swath_file,
                             zone_id, zone_db_file,
                             &projection, &zone_num,
                             zone_long, zone_lat, &zone_diam,
                             &min_duration,
                             &number_segments,
                             &bgn_orbit, &bgn_second,
                             &bgn_microsec, &bgn_cycle,
                             &end_orbit, &end_second,
                             &end_microsec, &end_cycle,
                             &coverage, ierr);
}
```

```

/* Or, using the run_id */
long run_id;

status = xv_zone_vis_time_run(&run_id,
                             &orbit_type,
                             &start_orbit, &start_cycle,
                             &stop_orbit, &stop_cycle,
                             &swath_flag, swath_file,
                             zone_id, zone_db_file,
                             &projection, &zone_num,
                             zone_long, zone_lat, &zone_diam,
                             &min_duration,
                             &number_segments,
                             &bgn_orbit, &bgn_second,
                             &bgn_microsec, &bgn_cycle,
                             &end_orbit, &end_second,
                             &end_microsec, &end_cycle,
                             &coverage, ierr);
}

```

For FORTRAN programs `xv_zone_vis_time` has the following calling sequence (input parameters are underlined, note that the C preprocessor must be used because of the presence of the `#include` statement):

```

INTEGER*4  SAT_ID, ORBIT_TYPE,
&          START_ORBIT, START_CYCLE,
&          STOP_ORBIT, STOP_CYCLE,
&          ZONE_NUM, PROJECTION,
&          NUMBER_SEGMENTS,
&          BGN_ORBIT(MAX_SEGMENTS),
&          BGN_SECOND(MAX_SEGMENTS),
&          BGN_MICROSEC(MAX_SEGMENTS),
&          BGN_CYCLE(MAX_SEGMENTS),
&          END_ORBIT(MAX_SEGMENTS),
&          END_SECOND(MAX_SEGMENTS),
&          END_MICROSEC(MAX_SEGMENTS),
&          END_CYCLE(MAX_SEGMENTS),
&          COVERAGE(MAX_SEGMENTS),
&          IERR[XV_NUM_ERR_ZONE_VIS_TIME],
          STATUS;

REAL*8    ZONE_LONG(ZONE_NUM), ZONE_LAT(ZONE_NUM),

```

---

& ZONE\_DIAM, MIN\_DURATION

CHARACTER\*(\*) ORBIT\_SCENARIO\_FILE, SWATH\_FILE, ZONE\_DB\_FILE

CHARACTER\*8 ZONE\_ID

#include"explorer\_visibility.inc"

STATUS = XV\_ZONE\_VIS\_TIME (

& SAT\_ID, ORBIT\_SCENARIO\_FILE,  
& ORBIT\_TYPE,  
& START\_ORBIT, START\_CYCLE,  
& STOP\_ORBIT, STOP\_CYCLE,  
& SWATH\_FILE, ZONE\_ID, ZONE\_DB\_FILE,  
& PROJECTION, ZONE\_NUM,  
& ZONE\_LONG, ZONE\_LAT, ZONE\_DIAM,  
& MIN\_DURATION,  
& NUMBER\_SEGMENTS,  
& BGN\_ORBIT, BGN\_SECOND,  
& BGN\_MICROSEC, BGN\_CYCLE,  
& END\_ORBIT, END\_SECOND,  
& END\_MICROSEC, END\_CYCLE, COVERAGE, IERR)

C test status

### 7.1.9 Input parameters

The `xv_zone_vis_time` CFI function has the following input parameters:

*Table 5: Input parameters of `xv_zone_vis_time` function*

C name	C type	Array Element	Description (Reference)	Unit (Format)	Allowed Range
<code>orbit_id</code>	<code>xo_orbit_id*</code>	-	Structure that contains the orbit data	-	-
<code>orbit_type</code>	<code>long*</code>	-	Define the type of orbit representation, i.e. absolute or relative orbits in the input/output parameters. Relative orbits only can be used when the <code>orbit_id</code> was initialized with orbital changes (with <code>xo_orbit_init_def</code> or with <code>xo_orbit_init_file</code> plus an OSF file). In other cases, only the value <code>XV_ORBIT_ABS</code> can be used.	-	Complete.
<code>start_orbit</code>	<code>long</code>	-	First orbit, segment filter. Segments will be filtered as from the beginning of first orbit. First Orbit for the orbit initialization will be used when: <ul style="list-style-type: none"> <li>• Absolute orbit is set to zero.</li> <li>• Relative orbit and cycle number set to zero.</li> </ul>	absolute or relative orbit number	= 0 or: <ul style="list-style-type: none"> <li>• absolute orbits <math>\geq</math> <code>start_osf</code></li> <li>• relative orbits <math>\leq</math> repeat cycle</li> </ul>
<code>start_cycle</code>	<code>long</code>	-	Cycle number corresponding to the <code>start_orbit</code> . Dummy when using absolute orbits	cycle number	= 0 or $\geq$ first cycle in osf

*Table 5: Input parameters of xv\_zone\_vis\_time function*

C name	C type	Array Element	Description (Reference)	Unit (Format)	Allowed Range
stop_orbit	long	-	Last orbit, segment filter. For orbit_id initialized with orbital changes, when: <ul style="list-style-type: none"> <li>• stop_orbit = 0 (for orbit_type = XV_ORBIT_ABS)</li> </ul> or <ul style="list-style-type: none"> <li>• stop_orbit = 0 and stop_cycle = 0 (for orbit_type = XV_ORBIT_REL)</li> </ul> the stop_orbit will be set to the minimum value between: <ul style="list-style-type: none"> <li>• the last orbit within the orbital change of the start_orbit.</li> <li>• start_orbit+cycle_length-1 (i.e. the input orbit range will be a complete cycle)</li> </ul>	absolute or relative orbit number	= 0 or: <ul style="list-style-type: none"> <li>• absolute orbits ≥ start_osf</li> <li>• relative orbits ≤ repeat cycle</li> </ul>
stop_cycle	long	-	Cycle number corresponding to the stop_orbit. Dummy when using absolute orbits	cycle number	= 0 or ≥ first cycle in osf
swath_flag	long*	-	Define the use of the swath file: <ul style="list-style-type: none"> <li>• 0 = (XV_STF) if the swath file is a swath template file.</li> <li>• &gt; 0 if the swath files is a swath definition file. In this case the swath points are generated for every “swath_flag” orbits</li> </ul>	-	XV_STF = 0 XV_SDF = 1 > 0
swath_file	char *	-	File name of the swath-file for the appropriate instrument mode		
zone_id[8]	char		Identification of the zone, as defined in zone_db_file. This parameter is used ONLY IF zone_num = 0		EXACTLY 8 characters
zone_db_file	char *		File name of the zone-database-file. This file is used ONLY IF zone_num = 0		



*Table 5: Input parameters of xv\_zone\_vis\_time function*

C name	C type	Array Element	Description (Reference)	Unit (Format)	Allowed Range
projection	long		projection used to define polygon sides as straight lines: = 0 Read projection from Zones DB (rectangular projection is used by default if the DB does not contain a projection) = 1 Azimuthal gnomonic = 2 Rectangular lat/long		
zone_num	long		Number of vertices of the zone provided in zone_long, zone_lat: = 0 no vertices provided, use zone_id / zone_db_file = 1 Point / Circular zone, = 2 Line zone > 2 Polygon zone		$\geq 0$
zone_long	double*	all	zone_long[i-1] Geocentric longitude of - circle centre, for circ. zone, i = 1 - point, for point zone, i = 1 - line-end, for line zone, i = 1 or 2 - vertices, for polygon zone, i = 1... zone_num		
zone_lat	double*	all	zone_lat[i-1] Geodetic latitude of - circle centre, for circ. zone, i = 1 - point, for point zone, i = 1 - line-end, for line zone, i = 1 or 2 - vertices, for polygon zone, i = 1... zone_num		
zone_diam	double		Zone diameter for circular zones, dummy for other zones If diameter equals 0.0 then zone is Point Zone	m	$\geq 0.0$
min_duration	double		Minimum duration for segments. Only segments with a duration longer than min_duration will be given on output.	s	$\geq 0$

It is also possible to use enumeration values rather than integer values for some of the input arguments, as

shown in the table below:

Input	Description	Enumeration value	long
projection	Read projection from the zones DB file	XV_READ_DB	0
	Azimuthal Gnomonic	XV_GNOMONIC	1
	Rectangular long/lat	XV_RECTANGULAR	2

### 7.1.10 Output parameters

The output parameters of the `xv_zone_vis_time` CFI function are:

*Table 6: Output parameters of xv\_zone\_vis\_time function*

C name	C type	Array Element	Description (Reference)	Unit (Format)	Allowed Range
<code>xv_zone_vis_time</code>	long		Function status flag, = 0 No error > 0 Warnings, results generated < 0 Error, no results generated		
<code>number_segments</code>	long		Number of visibility segments returned to the user.		≥ 0
<code>bgn_orbit</code>	long*	all	Orbit number, begin of visibility segment <i>i</i> <code>bgn_orbit[i-1]</code> , <i>i</i> = 1, <code>number_segments</code>		> 0
<code>bgn_second</code>	long*	all	Seconds since ascending node, begin of visibility segment <i>i</i> <code>bgn_second[i-1]</code> , <i>i</i> = 1, <code>number_segments</code>	s	≥ 0 < orbital period
<code>bgn_microsec</code>	long*	all	Micro seconds within second begin of visibility segment <i>i</i> <code>bgn_microsec[i-1]</code> , <i>i</i> = 1, <code>number_segments</code>	μs	≥ 0 ≤ 999999
<code>bgn_cycle</code>	long*	all	Cycle number, begin of visibility segment <i>i</i> <code>bgn_orbit[i-1]</code> , <i>i</i> = 1, <code>number_segments</code>		> 0 NULL when using absolute orbits
<code>end_orbit</code>	long*	all	Orbit number, end of visibility segment <i>i</i> <code>end_orbit[i-1]</code> , <i>i</i> = 1, <code>number_segments</code>		> 0
<code>end_second</code>	long*	all	Seconds since ascending node, end of visibility segment <i>i</i> <code>end_second[i-1]</code> , <i>i</i> = 1, <code>number_segments</code>	s	≥ 0 < orbital period
<code>end_microsec</code>	long*	all	Micro seconds within second end of visibility segment <i>i</i> <code>end_microsec[i-1]</code> , <i>i</i> = 1, <code>number_segments</code>	μs	≥ 0 ≤ 999999

Table 6: Output parameters of `xv_zone_vis_time` function

C name	C type	Array Element	Description (Reference)	Unit (Format)	Allowed Range
<code>end_cycle</code>	<code>long*</code>	all	Cycle number, end of visibility segment <code>i</code> <code>end_orbit[i-1]</code> , <code>i = 1, number_segments</code>		>0 NULL when using absolute orbits
<code>coverage</code>	<code>long*</code>	all	Zone coverage flag for segment = 0 Zone completely covered by swath = 1 Zone not completely covered by swath, extending over the left edge of the swath. = 2 Zone not completely covered by swath, extending over the right edge of the swath. = 3 Zone not completely covered by swath, extending over both edges of the swath  <code>coverage[i]</code> , <code>i = 0, (number_segments-1)</code>		
<code> ierr[XV_NUM_ERR_ZONE_VIS_TIME]</code>	<code>long</code>		Error status flags		

It is also possible to use enumeration values rather than integer values for some of the output arguments, as shown in the table below:

Input	Description	Enumeration value	long
<code>coverage</code>	Zone completely covered by swath	<code>XV_COMPLETE</code>	0
	Left extreme transitions found	<code>XV_LEFT</code>	1
	Right extreme transitions found	<code>XV_RIGHT</code>	2
	Both extreme transitions found	<code>XV_BOTH</code>	3

**Memory Management:** Note that the output visibility segments arrays are pointers to integers instead of static arrays. The memory for these dynamic arrays is allocated within the `xv_zone_vis_time` function. So the user will only have to declare those pointers but not to allocate memory for them. However, once the function has returned without error, the user will have the responsibility of freeing the memory for those pointers once they are not used.

### 7.1.11 Warnings and errors

Next table lists the possible error messages that can be returned by the **xv\_zone\_vis\_time** CFI function after translating the returned status vector into the equivalent list of error messages by calling the function of the EXPLORER\_VISIBILITY software library **xv\_get\_msg**.

This table also indicates the type of message returned, i.e. either a warning (WARN) or an error (ERR), the cause of such a message and the impact on the performed calculation, mainly on the results vector.

The table is completed by the error code and value. These error codes can be obtained translating the status vector returned by the **xv\_zone\_vis\_time** CFI function by calling the function of the EXPLORER\_VISIBILITY software library **xv\_get\_code**.

Error type	Error message	Cause and impact	Error Code	Error No
ERR	Input parameter "Number of ZONE points" is wrong.	Computation not performed	XV_CFI_ZONE_VIS_TIME_NEGATIVE_NUM_ZONE_ERR	0
ERR	Input parameter "Orbit Id" is wrong.	Computation not performed	XV_CFI_ZONE_VIS_TIME_ORBIT_STATUS_ERR	1
ERR	Input parameter "orbit_type" is out of range.	Computation not performed	XV_CFI_ZONE_VIS_TIME_ORBIT_TYPE_ERR	2
ERR	Input parameter "Minimum duration" cannot be negative.	Computation not performed	XV_CFI_ZONE_VIS_TIME_NEGATIVE_MIN_DURATION_ERR	3
ERR	Input parameter "Projection" out of range.	Computation not performed	XV_CFI_ZONE_VIS_TIME_PROJECTION_OUT_OF_RANGE_ERR	4
ERR	Wrong swath_flag value	Computation not performed	XV_CFI_ZONE_VIS_TIME_SWATH_FLAG_ERR	5
ERR	Could not generate the swath template file	Computation not performed	XV_CFI_ZONE_VIS_TIME_GENSWATH_ERR	6
ERR	Error generating visibility segments for orbit "%d"		XV_ZONE_VIS_TIME_IN_ORBIT_ERR	7
ERR	Error reading Swath Template File.	Computation not performed	XV_CFI_ZONE_VIS_TIME_READ_SWATH_FILE_ERR	8
ERR	Swath type not allowed	Computation not performed	XV_CFI_ZONE_VIS_TIME_INCORRECT_SWATH_TYPE_ERR	9
ERR	Cannot allocate memory for the Swath Template File	Computation not performed	XV_CFI_ZONE_VIS_TIME_ALLOCATE_SWATH_MEMORY_ERR	10

Error type	Error message	Cause and impact	Error Code	Error No
ERR	Input parameter "start_orbit" cannot be negative.	Computation not performed	XV_CFI_ZONE_VIS_TIME _NEGATIVE_START_ORBIT_ERR	11
ERR	Error reading OEF/OSF file.	Computation not performed	XV_CFI_ZONE_VIS_TIME _READ_OSF_ERR	12
WARN	"start_orbit" is before the first orbit in "orbit_event_file".	Computation performed. Message to inform the user.	XV_CFI_ZONE_VIS_TIME _EARLIER_START_ORBIT_WARN	13
WARN	"stop_orbit" is after the last orbit in "orbit_event_file".	Computation performed. Message to inform the user.	XV_CFI_ZONE_VIS_TIME _LATER_STOP_ORBIT_WARN	14
ERR	Input parameter "start_orbit" cannot be greater than "stop_orbit".	Computation not performed	XV_CFI_ZONE_VIS_TIME _WRONG_ORBIT_RANGE_ERR	15
ERR	Error calling "xv_orbitinfo".	Computation not performed	XV_CFI_ZONE_VIS_TIME _ORBITINFO_CALL_ERR	16
ERR	"cycle_length" read from the input "Swath Template File" is not equal to that of any orbits within the orbit range	Computation not performed	XV_CFI_ZONE_VIS_TIME _INCONSISTENT_SWATH_ERR	17
WARN	There is at least one orbital change within the requested orbit range.	Computation performed. Message to inform the user.	XV_CFI_ZONE_VIS_TIME _ORBITAL_CHANGE_WARN	18
ERR	Input parameter "zone_id" is an empty string.	Computation not performed	XV_CFI_ZONE_VIS_TIME _ZONE_ID_EMPTY_ERR	19
ERR	Number of characters in input string "zone_id" is different from %li.	Computation not performed	XV_CFI_ZONE_VIS_TIME _WRONG_ZONE_ID_LENGTH_ERR	20
ERR	Error reading the ZONE Database file.	Computation not performed	XV_CFI_ZONE_VIS_TIME _READ_ZONE_DB_FILE_ERR	21
WARN	"Projection" parameter set to default.	Computation performed. Message to inform the user.	XV_CFI_ZONE_VIS_TIME _DEFAULT_PROJECTION_WARN	22
ERR	Cannot allocate memory for the ZONE records."	Computation not performed	XV_CFI_ZONE_VIS_TIME _ALLOCATE_ZONE_MEMORY_ERR	23
ERR	Latitude must be in the range [-90.0 , 90.0].	Computation not performed	XV_CFI_ZONE_VIS_TIME _WRONG_LATITUDE_RANGE_ERR	24

Error type	Error message	Cause and impact	Error Code	Error No
WARN	Two consecutive points are equal, only one is used.	Computation performed. Message to inform the user.	XV_CFI_ZONE_VIS_TIME _TWO_EQUAL_POINTS_ WARN	25
ERR	Difference in longitude for 2 consecutive ZONE points is equal to 180.0 degrees (RECTANGULAR projection). Zone definition is ambiguous.	Computation not performed	XV_CFI_ZONE_VIS_TIME _DIFF_LONG_180_ERR	26
ERR	Two consecutive ZONE points are antipodal (GNOMONIC projection). Zone definition is ambiguous.	Computation not performed	XV_CFI_ZONE_VIS_TIME _ANTIPODAL_POINTS_E RR	27
ERR	Error precomputing intersection of two segments.	Computation not performed	XV_CFI_ZONE_VIS_TIME _SEGMENT_INTERSECT_ PREC_ERR	28
ERR	Error computing intersection of two segments.	Computation not performed	XV_CFI_ZONE_VIS_TIME _SEGMENT_INTERSECT_ COMP_ERR	29
ERR	Error computing gnomonic coordinates.	Computation not performed	XV_CFI_ZONE_VIS_TIME _GNOMONIC_COORD_ER R	30
ERR	Two ZONE segments intersect.	Computation not performed	XV_CFI_ZONE_VIS_TIME _TWO_SEGMENTS_INTE RSECT_ERR	31
ERR	Two consecutive ZONE segments are aligned in the same direction.	Computation not performed	XV_CFI_ZONE_VIS_TIME _ALLIGNED_SEGMENTS_ ERR	32
ERR	Input parameter "ZONE diameter" cannot be negative (POINT or CIRCLE zone).	Computation not performed	XV_CFI_ZONE_VIS_TIME _ZONE_DIAM_NEGATIVE _ERR	33
ERR	SWATH contains the POLE (RECTANGULAR projection).	Computation not performed	XV_CFI_ZONE_VIS_TIME _POLE_IN_SWATH_ERR	34
ERR	Not convex SWATH quadrilateral for the specified latitude range.	Computation not performed	XV_CFI_ZONE_VIS_TIME _CUADRILATERAL_NOT_ CONVEX_ERR	35
ERR	Error checking if a point is inside a quadrilateral.	Computation not performed	XV_CFI_ZONE_VIS_TIME _POINT_IN_CUADRILATE RAL_ERR	36
ERR	Error sorting intersections.	Computation not performed	XV_CFI_ZONE_VIS_TIME _SORT_INTERSECTIONS_ ERR	37

Error type	Error message	Cause and impact	Error Code	Error No
ERR	Cannot (re)allocate memory for the segments.	Computation not performed	XV_CFI_ZONE_VIS_TIME_SEGMENTS_MEMORY_ERR	38
ERR	Too many time segments (more than MAX_ORBITS).	Computation not performed	XV_CFI_ZONE_VIS_TIME_MAX_ORBITS_ERR	39
ERR	Cannot allocate memory for the coverage.	Computation not performed	XV_CFI_ZONE_VIS_TIME_COVERAGE_MEMORY_ERR	40
WARN	Warning checking the visibility segments.	Computation performed. Message to inform the user.	XV_CFI_ZONE_VIS_TIME_CHECK_SEGMENTS_WARN	41
ERR	Error checking the visibility segments.	Computation not performed	XV_CFI_ZONE_VIS_TIME_CHECK_SEGMENTS_ERR	42
ERR	Error computing final segments for the POINT swath and POINT zone.	Computation not performed	XV_CFI_ZONE_VIS_TIME_ORBIT_TO_TIME_CALL_ERR	43
ERR	Wrong input Orbit Id. Unknown orbit initialization mode	Computation not performed	XV_CFI_ZONE_VIS_TIME_ORBIT_MODEL_ERR	44
WARN	"stop_orbit" is after the last orbit in the orbit file.	Computation performed. Message to inform the user.	XV_CFI_ZONE_VIS_TIME_STOP_ORBIT_WARN	45
ERR	Error computing the ANX longitude	Computation not performed	XV_CFI_ZONE_VIS_TIME_COMPUTE_ANX_ERR	46
ERR	Error calling "orbit info"	Computation not performed	XV_CFI_ZONE_VIS_TIME_ORBIT_INFO_ERR	47

Note that error codes and messages have been completely modified since the last issue due to a completely new implementation of the CFI function.



---

### ***7.1.12 Runtime performances***

The following runtime performance has been measured.

*Table 7: Runtime performances of xv\_zone\_vis\_time function*

Ultra Sparc [ms]
TBD

## 7.2 xv\_station\_vis\_time

### 7.2.1 Overview

The **xv\_station\_vis\_time** function computes ground station visibility segments, the orbital segments for which the satellite is visible from a ground station located at the surface of the Earth.

An orbital segment is a time interval along the orbit, defined by start and stop times expressed as seconds elapsed since the ascending node crossing.

In addition, **xv\_station\_vis\_time** calculates for every visibility segment the time of zero-doppler (i.e. the time at which the range-rate to the station is zero).

**xv\_station\_vis\_time** requires access to several data structures and files to produce its results:

- the orbit\_id (xo\_orbit\_id) providing the orbital data. The orbit\_id can be initialized with the following data and files (see [ORBIT\_SUM]):
  - data for an orbital change
  - Orbit scenario files
  - Predicted orbit files
  - Orbit Event Files
  - Restituted orbit files
  - DORIS Preliminary orbit files
  - DORIS Navigator files
- the Instrument Swath File, describing the area seen by the relevant instrument all along the current orbit. The Swath data can be provided by:
  - A swath template file produced off-line by the EXPLORER\_VISIBILITY library (**xv\_gen\_swath** function).
  - A swath definition file, describing the swath geometry. In this case the **xv\_station\_vis\_time** generates the swath points for a number of orbits given by the user.
- The Station Database File, describing the location and the physical mask of each ground station.

The time intervals used by **xv\_station\_vis\_time** are expressed in absolute or relative orbit numbers. This is valid for both:

- input parameter “Orbit Range”: first and last orbit to be considered. In case of using relative orbits, the corresponding cycle number should be used, otherwise, this the cycle number will be a dummy parameter.
- output parameter “Station Visibility Segments”: time segments with time expressed as {absolute orbit number (or relative orbit and cycle number), number of seconds since ANX, number of microseconds}

The orbit representation (absolute or relative) for the output segments will be the same as in the input orbits. Moreover, the segments will be ordered chronologically.

Users who need to use processing times must make use of the conversion routines provided in EXPLORER\_ORBIT (**xo\_time\_to\_orbit** and **xo\_orbit\_to\_time** functions).

**NOTE:** Since the orbit swath template file is generated from a reference orbit, it is not recommended to use **xv\_station\_vis\_time** for a range of orbits that includes an orbital change (e.g. change in the repeat cycle or cycle length). If this would happen, **xv\_station\_vis\_time** automatically will ignore those orbits that do not correspond with the template file (i.e. no visibility segments will be generated for those orbits).

## 7.2.2 Calling interface

For C programs, the call to `xv_station_vis_time` is (input parameters are underlined):

```
#include "explorer_visibility.h"
{
    xo_orbit_id orbit_id = {NULL};
    long        swath_flag, orbit_type,
               start_orbit, start_cycle,
               stop_orbit, stop_cycle,
               mask, number_segments,
               *bgn_orbit, *bgn_second,
               *bgn_microsec, *bgn_cycle,
               *end_orbit, *end_second,
               *end_microsec, *end_cycle,
               *zdop_orbit, *zdop_second,
               *zdop_microsec, *zdop_cycle,
               ierr[XV_NUM_ERR_STATION_VIS_TIME],
               status;

    double     aos_elevation, los_elevation, min_duration;
    char       *swath_file;
    char       sta_id[8], *sta_db_file;

    status = xv_station_vis_time(
        &orbit_id, &orbit_type,
        &start_orbit, &start_cycle,
        &stop_orbit, &stop_cycle,
        &swath_flag, &swath_file, sta_id, sta_db_file,
        &mask, &aos_elevation, &los_elevation,
        &min_duration,
        &number_segments,
        &bgn_orbit, &bgn_second,
        &bgn_microsec, &bgn_cycle,
        &end_orbit, &end_second,
        &end_microsec, &end_cycle,
        &zdop_orbit, &zdop_second,
        &zdop_microsec, &zdop_cycle,
        ierr);
}
```

---

```
/* Or, using the run_id */  
long run_id;  
  
status = xv_station_vis_time_run(  
    &run_id, &orbit_type,  
    &start_orbit, &start_cycle,  
    &stop_orbit, &stop_cycle,  
    &swath_flag, &swath_file, sta_id, sta_db_file,  
    &mask, &aos_elevation, &los_elevation,  
    &min_duration,  
    &number_segments,  
    &bgn_orbit, &bgn_second,  
    &bgn_microsec, &bgn_cycle,  
    &end_orbit, &end_second,  
    &end_microsec, &end_cycle,  
    &zdop_orbit, &zdop_second,  
    &zdop_microsec, &zdop_cycle,  
    ierr);  
}
```

For FORTRAN programs **xv\_station\_vis\_time** has the following calling sequence (input parameters are underlined, note that the C preprocessor must be used because of the presence of the #include statement):

```

    INTEGER*4  SAT_ID, ORBIT_TYPE,
&            START_ORBIT, START_CYCLE,
&            STOP_ORBIT, STOP_CYCLE,
&            MASK, NUMBER_SEGMENTS,
&            BGN_ORBIT(MAX_SEGMENTS),
&            BGN_SECOND(MAX_SEGMENTS),
&            BGN_MICROSEC(MAX_SEGMENTS),
&            BGN_CYCLE(MAX_SEGMENTS),
&            END_ORBIT(MAX_SEGMENTS),
&            END_SECOND(MAX_SEGMENTS),
&            END_MICROSEC(MAX_SEGMENTS),
&            END_MICROSEC(MAX_SEGMENTS),
&            ZDOP_ORBIT(MAX_SEGMENTS),
&            ZDOP_SECOND(MAX_SEGMENTS),
&            ZDOP_MICROSEC(MAX_SEGMENTS),
&            ZDOP_MICROSEC(MAX_SEGMENTS),
&            IERR(XV_NUM_ERR_STATION_VIS_TIME),
    STATUS
REAL*8       AOS_ELEVATION, LOS_ELEVATION, MIN_DURATION;
CHAR*(*)    *ORBIT_SCENARIO_FILE, *SWATH_FILE;
CHAR*8      STA_ID
  
```

```
#include"ppf_visibility.inc"
```

```

    STATUS = XV_STATION_VIS_TIME(
&            SAT_ID, ORBIT_SCENARIO_FILE, ORBIT_TYPE,
&            START_ORBIT, START_CYCLE, STOP_ORBIT, STOP_CYCLE,
&            SWATH_FILE, STA_ID, STA_DB_FILE,
&            MASK, AOS_ELEVATION, LOS_ELEVATION,
&            MIN_DURATION, NUMBER_SEGMENTS,
&            BGN_ORBIT, BGN_SECOND,
&            BGN_MICROSEC, BGN_CYCLE,
&            END_ORBIT, END_SECOND,
&            END_MICROSEC, END_CYCLE,
&            ZDOP_ORBIT, ZDOP_SECOND,
&            ZDOP_MICROSEC, ZDOP_CYCLE,
    IERR);
  
```

C test status

### 7.2.3 Input parameters

**Table 8: Input parameters of xv\_station\_vis\_time**

c name	c type	Array Element	Description	Units	Range
orbit_id	xo_orbit_id*	-	Structure that contains the orbit data	-	-
orbit_type	long	-	Define the type of orbit representation, i.e. absolute or relative orbits in the input/output parameters	-	Complete
start_orbit	long	-	First orbit, segment filter. Segments will be filtered as from the beginning of first orbit (within orbit range from orbit_scenario_file) First Orbit in the orbit_scenario_file will be used when: <ul style="list-style-type: none"> <li>Absolute orbit is set to zero.</li> <li>Relative orbit and cycle number set to zero.</li> </ul>	absolute or relative orbit number	= 0 or: <ul style="list-style-type: none"> <li>absolute orbits <math>\geq</math> start_osf</li> <li>relative orbits <math>\leq</math> repeat cycle</li> </ul>
start_cycle	long	-	Cycle number corresponding to the start_orbit. Dummy when using relative orbits	cycle number	= 0 or $\geq$ first cycle in osf
stop_orbit	long	-	Last orbit, segment filter. When: <ul style="list-style-type: none"> <li>stop_orbit = 0 (for orbit_type = XV_ORBIT_ABS)</li> <li>stop_orbit = 0 and stop_cycle = 0 (for orbit_type = XV_ORBIT_REL)</li> </ul> the stop_orbit will be set to the minimum value between: <ul style="list-style-type: none"> <li>the last orbit within the orbital change of the start_orbit.</li> <li>start_orbit+cycle_length-1 (i.e. the input orbit range will be a complete cycle)</li> </ul>	absolute or relative orbit number	= 0 or: <ul style="list-style-type: none"> <li>absolute orbits <math>\geq</math> start_osf</li> <li>relative orbits <math>\leq</math> repeat cycle</li> </ul>
stop_cycle	long	-	Cycle number corresponding to the stop_orbit. Dummy when using relative orbits	cycle number	= 0 or $\geq$ first cycle in osf

**Table 8: Input parameters of xv\_station\_vis\_time**

c name	c type	Array Element	Description	Units	Range
swath_flag	long*	-	Define the use of the swath file: <ul style="list-style-type: none"> <li>• 0 = (XV_STF) if the swath file is a swath template file.</li> <li>• &gt; 0 if the swath files is a swath definition file. In this case the swath points are generated for every “swath_flag” orbits</li> </ul>	-	XV_STF = 0 XV_SDF = 1 > 0
swath_file	char *	-	File name of the swath-file for the appropriate instrument mode		
sta_id[8]	char		identification name of the station		
station_db_file	char *		File name of the station database file This file is read each time the function is called		
mask	long		mask used to define visibility = 0 combine AOS/LOS elevations and physical mask (nominal mode) = 1 consider only AOS/LOS elevations = 2 consider only physical mask		≥ 0
aos_elevation	double		Minimum elevation to consider at AOS (i.e. before considering start of visibility).	deg	≥ 0.0
los_elevation	double		Maximum elevation to consider at LOS (i.e. before considering end of visibility).	deg	≥ 0.0 ≤ aos_elevation
min_duration	double		Minimum duration for segments. Only segments with a duration longer than min_duration will be given on output.	s	≥ 0.0

It is also possible to use enumeration values rather than integer values for some of the input arguments, as

shown in the table below:

Input	Description	Enumeration value	long
mask	Combine AOS/LOS and physical mask	XV_COMBINE	0
	Use only AOS/LOS	XV_AOS_LOS	1
	Use only physical mask	XV_PHYSICAL	2



## 7.2.4 Output parameters

**Table 9: Output parameters of xv\_station\_vis\_time function**

c name	c type	Array Element	Description	Unit	Range
xv_station_vis_time	long		Function status flag, = 0 No error > 0 Warnings, results generated < 0 Error, no results generated		
number_segments	long		Number of visibility segments returned to the user		≥ 0
bgn_orbit	long*	all	Orbit number, begin of visibility segment i bgn_orbit[i-1], i = 1, number_segments		> 0
bgn_second	long*	all	Seconds since ascending node, begin of visibility segment i bgn_second[i-1], i = 1, number_segments	s	≥ 0 < orbital period
bgn_microsec	long*	all	Micro seconds within second begin of visibility segment i bgn_microsec[i-1], i = 1, number_segments	μs	≥ 0 ≤ 999999
bgn_cycle	long*	all	Cycle number, begin of visibility segment i bgn_cycle[i-1], i = 1, number_segments		> 0 NULL when using absolute orbits
end_orbit	long*	all	Orbit number, end of visibility segment i end_orbit[i-1], i = 1, number_segments		> 0
end_second	long*	all	Seconds since ascending node, end of visibility segment i end_second[i-1], i = 1, number_segments	s	≥ 0 < orbital period
end_microsec	long*	all	Micro seconds within second end of visibility segment i end_microsec[i-1], i = 1, number_segments	μs	≥ 0 ≤ 999999

**Table 9: Output parameters of xv\_station\_vis\_time function**

c name	c type	Array Element	Description	Unit	Range
end_cycle	long*	all	Cycle number, end of visibility segment i end_cycle[i-1], i = 1, number_segments		>0 NULL when using absolute orbits
zdop_orbit	long*	all	Orbit number, time of zero doppler (-1 if no zero doppler within corresponding visibility segment) zdop_orbit[i-1], i = 1, number_segments		> 0
zdop_second	long*	all	Seconds since ascending node, time of zero doppler (-1 if no zero doppler within corresponding visibility segment) zdop_second[i-1], i = 1, number_segments	s	>= 0 < orbital period
zdop_microsec	long*	all	Micro seconds within second time of zero doppler (-1 if no zero doppler within corresponding visibility segment) zdop_microsec[i-1], i = 1, number_segments	μs	0 =< =< 999999
zdop_cycle	long*	all	Cycle number, time of zero doppler (-1 if no zero doppler within corresponding visibility segment) zdop_second[i-1], i = 1, number_segments		>0 NULL when using absolute orbits
ierr[XV_NUM_ER R_STATION_VIS_ TIME]	long		Error status flags		

**Memory Management:** Note that the output visibility segments arrays are pointers to integers instead of static arrays. The memory for these dynamic arrays is allocated within the **xv\_station\_vis\_time** function. So the user will only have to declare those pointers but not to allocate memory for them. However, once the function has returned without error, the user will have the responsibility of freeing the memory for those pointers once they are not used.

### 7.2.5 Warnings and errors

Next table lists the possible error messages that can be returned by the **xv\_station\_vis\_time** CFI function after translating the returned status vector into the equivalent list of error messages by calling the function of the EXPLORER\_VISIBILITY software library **xv\_get\_msg**.

This table also indicates the type of message returned, i.e. either a warning (WARN) or an error (ERR), the cause of such a message and the impact on the performed calculation, mainly on the results vector.

The table is completed by the error code and value. These error codes can be obtained translating the status vector returned by the **xv\_station\_vis\_time** CFI function by calling the function of the EXPLORER\_VISIBILITY software library **xv\_get\_code**.

Error type	Error message	Cause and impact	Error Code	Error No
ERR	Error in input parameter Orbit Id.	Computation not performed	XV_CFI_STATION_VIS_TIME_ORBIT_STATUS_ERR	0
ERR	Error in input parameter to stavistime.	Computation not performed	XV_CFI_STATION_VIS_TIME_INPUTS_CHECK_ERR	1
ERR	Error transforming start orbit from relative to absolute orbits.	Computation not performed	XV_CFI_STATION_VIS_TIME_REL_TO_ABS_START_ERR	2
ERR	Error transforming stop orbit from relative to absolute orbits	Computation not performed	XV_CFI_STATION_VIS_TIME_REL_TO_ABS_STOP_ERR	3
ERR	Error reading the Orbit scenario file.	Computation not performed	XV_CFI_STATION_VIS_TIME_OSF_READ_ERR	4
ERR	Error reading the swath template file.	Computation not performed	XV_CFI_STATION_VIS_TIME_SWATH_READ_ERR	5
ERR	Error wrong swath type selected.	Computation not performed	XV_CFI_STATION_VIS_TIME_SWATH_TYPE_ERR	6
WARN	Warning, start orbit is outside range of OSF.	Computation performed. Message to inform the user.	XV_CFI_STATION_VIS_TIME_FIRST_ORBIT_WARN	7
WARN	Warning, stop orbit is outside range of OSF.	Computation performed. Message to inform the user.	XV_CFI_STATION_VIS_TIME_LAST_ORBIT_WARN	8
ERR	Actual stop orbit is earlier than actual start orbit.	Computation not performed	XV_CFI_STATION_VIS_TIME_WRONG_INTERVAL_ERR	9
ERR	Error obtaining orbital information in orbit info.	Computation not performed	XV_CFI_STATION_VIS_TIME_ORBIT_INFO_ERR	10
WARN	Warning, there is an orbital change within the requested orbits.	Computation performed. Message to inform the user.	XV_CFI_STATION_VIS_TIME_ORBIT_CHANGE_WARN	11
ERR	Error allocating internal memory.	Computation not performed	XV_CFI_STATION_VIS_TIME_INTERNAL_MEMORY_ERR	12

Error type	Error message	Cause and impact	Error Code	Error No
ERR	There is a potential memory overload, try with a smaller orbital interval.	Computation not performed	XV_CFI_STATION_VIS_TIME_POTENTIAL_MEMORY_ERR	13
ERR	Orbital information does not coincide with reference swath.	Computation not performed	XV_CFI_STATION_VIS_TIME_INCONSISTENT_SWATH_ERR	14
ERR	Error read into the ground station's mask data file.	Computation not performed	XV_CFI_STATION_VIS_TIME_READ_STA_ERR	15
ERR	Error transforming the station's mask into an equivalent zone.	Computation not performed	XV_CFI_STATION_VIS_TIME_AZEL2LONLAT_ERR	16
ERR	Error calling ZONEVISTIME to calculate transitions.	Computation not performed	XV_CFI_STATION_VIS_TIME_ZONE_VIS_TIME_CALL_ERR	17
ERR	Error refining intersection time.	Computation not performed	XV_CFI_STATION_VIS_TIME_CALL_STAVIS_ERR	18
WARN	Accuracy of 0.001 deg in elevation not reached in orbit %li. Orbit too close to the mask limit.	Computation performed. Message to inform the user.	XV_CFI_STATION_VIS_TIME_CALL_STAVIS_WARN	19
ERR	Error allocating memory for the time segments.	Computation not performed.	XV_CFI_STATION_VIS_TIME_SEGMENTS_MEMORY_ERR	20
ERR	Error calculating zero doppler interval.	Computation not performed	XV_CFI_STATION_VIS_TIME_ZERO_DOPPLER_ERR	21
WARN	Segment longer than half nodal period deleted.	Computation performed. Message to inform the user.	XV_CFI_STATION_VIS_TIME_LONG_SEGM_SKIPPED_WARN	22
ERR	Error transforming from absolute to relative.	Computation not performed	XV_CFI_STATION_VIS_TIME_ABS_TO_REL_ERR	23

---

### 7.2.6 Runtime performances

The following runtime performance has been measured.

*Table 10: Runtime performances of xv\_station\_vis\_time function*

Ultra Sparc [ms]
TBD

---

## 7.3 xv\_drs\_vis\_time

### 7.3.1 Overview

The **xv\_drs\_vis\_time** function computes all the orbital segments for which the satellite is visible from a data relay satellite located in a geostationary orbit.

An orbital segment is a time interval along the orbit, defined by start and stop times expressed as seconds elapsed since the ascending node crossing.

**xv\_drs\_vis\_time** requires access to requires access to the orbit\_id (xo\_orbit\_id) data structure. This structure can be initialized using one of the following set of data or files (see [ORBIT\_SUM]):

- data for an orbital change
- Orbit scenario files
- Predicted orbit files
- Orbit Event Files
- Restituted orbit files
- DORIS Preliminary orbit files
- DORIS Navigator files

The time intervals used by **xv\_drs\_vis\_time** are expressed in absolute or relative orbit numbers. This is valid for both:

- input parameter “Orbit Range”: first and last orbit to be considered. In case of using relative orbits, the corresponding cycle number should be used, otherwise, this the cycle number will be a dummy parameter.
- output parameter “Data Relay Satellite Visibility Segments”: time segments with time expressed as {absolute orbit number (or relative orbit and cycle number), number of seconds since ANX, number of microseconds }

The orbit representation (absolute or relative) for the output segments will be the same as in the input orbits. Moreover, the segments will be ordered chronologically.

Users who need to use processing times must make use of the conversion routines provided in EXPLORER\_VISIBILITY (**xo\_time\_to\_orbit** and **xv\_orbit\_to\_time** functions).

It is assumed that the DRS orbit has zero inclination.

The **xv\_drs\_vis\_time** function considers the following sources of occultation:

- Earth plus 20 km of atmosphere
- Satellite dependant sources (Currently, only Envisat model is implemented):
  - Fixed appendages: 1 deg half cone around:
    - Service Module
    - Payload Module
    - Module Interface
    - ASAR antenna
    - AATSR Payload
    - ATSR Radiator

- Mipas Payload
- Mipas Electronics
- Sciamachy Radiators A, B and C
- UMI
- Star Trackers, enlarged to have a 16 deg halfcone to protect against radiation.
- S Band Antennas
- Rotating appendices (solar array and its structure): 1 deg half cone around solar array and supporting structure
- Azimuth Blockage (165 deg to 195 deg, MCD convention for the azimuth and elevation angles)
- Elevation Blockage (-86 deg to -90 deg, MCD convention for the azimuth and elevation angles)

Operations of the antenna are also limited to the values (APM definition):

- Elevation from -30.0 deg to +90.0 deg
- Azimuth from -165.0 deg to +165.0 deg

These operations limitations are imposed considering margins of 1.0 deg.

In addition to these occultation sources, the function **xv\_drs\_vis\_time** checks that the initial movement of the antenna (start-up trajectory) does not violate any mechanical constraints in order to reach the corresponding pointing to the DRS at the beginning time of the visibility segment. Similar computations are performed to be able to stop the antenna at the end point of the visibility segment.

In case the mechanical constraints are violated for a visibility segment, it is reduced by 1 second and the condition is checked again. The process is repeated until both trajectories are within the limits. A warning message is raised if the visibility segment duration comes to be smaller than the minimum duration defined by the user (*min\_duration*).

The considerations assumed in the implementation of the start-up and stop trajectories are the following:

Concept	Start-up Trajectory	Stop Trajectory
Angular movements	Common time for azimuth and elevation movement	No common time for azimuth and elevation movement
Azimuth acceleration	$AZ_{acc} = 0.015 \text{ deg/sec}^2$	Low Velocity: $AZ_{acc} = 0.023 \text{ deg/sec}^2$
		High Velocity: $AZ_{acc} = 0.043 \text{ deg/sec}^2$
Elevation acceleration	$EL_{acc} = 0.004 \text{ deg/sec}^2$	Low Velocity: $EL_{acc} = 0.02 \text{ deg/sec}^2$
		High Velocity: $EL_{acc} = 0.02 \text{ deg/sec}^2$
Velocity limit	N/A	$vel_{limit} = 0.11459 \text{ deg/sec}$

**Table 11: Assumptions for the start-up and stop trajectory computations**

### 7.3.2 Calling interface

For C programs, the call to `xv_drs_vis_time` is (input parameters are underlined):

```
#include "explorer_visibility.h"
{
    xo_orbit_id          orbit_id = {NULL};
    xp_sat_nom_trans_id sat_nom_trans_id = {NULL};
    xp_sat_trans_id      sat_trans_id = {NULL};
    xp_instr_trans_id    instr_trans_id = {NULL};
    long                 orbit_type,
                       start_orbit, start_cycle,
                       stop_orbit, stop_cycle,
                       number_segments,
                       *bgn_orbit, *bgn_second,
                       *bgn_microsec, *bgn_cycle,
                       *end_orbit, *end_second,
                       *end_microsec, *end_cycle,
                       ierr[XV_NUM_ERR_DRS_VIS_TIME],
                       status;
    double              min_duration, longitude;

    status = xv_drs_vis_time(
        &orbit_id, &sat_nom_trans_id,
        &sat_trans_id, &instr_trans_id, &orbit_type,
        &start_orbit, &start_cycle,
        &stop_orbit, &stop_cycle,
        &longitude, &min_duration,
        &number_segments,
        &bgn_orbit, &bgn_second,
        &bgn_microsec, &bgn_cycle,
        &end_orbit, &end_second,
        &end_microsec, &end_cycle,
        ierr);

    /* Or, using the run_id */
    long run_id;

    status = xv_drs_vis_time_run(
        &run_id, &orbit_type,
        &start_orbit, &start_cycle,
        &stop_orbit, &stop_cycle,
```



```

        &longitude, &min_duration,
        &number_segments,
        &bgn_orbit, &bgn_second,
        &bgn_microsec, &bgn_cycle,
        &end_orbit, &end_second,
        &end_microsec, &end_cycle,
        ierr);
}

```

For FORTRAN programs **xv\_drs\_vis\_time** has the following calling sequence (input parameters are underlined, note that the C preprocessor must be used because of the presence of the #include statement):

```

    INTEGER*4    SAT_ID, ORBIT_TYPE,
    &            START_ORBIT, START_CYCLE,
    &            STOP_ORBIT, STOP_CYCLE,
    &            NUMBER_SEGMENTS,
    &            BGN_ORBIT(MAX_SEGMENTS), BGN_SECOND(MAX_SEGMENTS),
    &            BGN_MICROSEC(MAX_SEGMENTS), BGN_CYCLE(MAX_SEGMENTS),
    &            END_ORBIT(MAX_SEGMENTS), END_SECOND(MAX_SEGMENTS),
    &            END_MICROSEC(MAX_SEGMENTS), END_CYCLE(MAX_SEGMENTS),
    &            IERR(XV_NUM_ERR_DRS_VIS_TIME),
    STATUS
    REAL*8      MIN_DURATION, LONGITUDE
    CHARACTER*(*)ORBIT_SCENARIO_FILE

```

```
#include"explorer_visibility.inc"
```

```

    STATUS = XV_DRS_VIS_TIME(
    &            SAT_ID, ORBIT_SCENARIO_FILE, ORBIT_TYPE,
    &            START_ORBIT, START_CYCLE,
    &            STOP_ORBIT, STOP_CYCLE,
    &            LONGITUDE, MIN_DURATION,
    &            NUMBER_SEGMENTS,
    &            BGN_ORBIT, BGN_SECOND,
    &            BGN_MICROSEC, BGN_CYCLE,
    &            END_ORBIT, END_SECOND,
    &            END_MICROSEC, END_CYCLE,
    IERR)

```

C test status

### 7.3.3 Input parameters

Table 12: Input parameters of xv\_drs\_vis\_time

c name	c type	Array Element	Description	Units	Range
orbit_id	xo_orbit_id*	-	Structure that contains the orbit data	-	-
sat_nom_trans_id	xp_sat_nom_trans_id*	-	Structure that contains the Instr. Trans.	-	-
sat_trans_id	xp_sat_trans_id*	-	Structure that contains the Instr. Trans.	-	-
instr_trans_id	xp_instr_trans_id*	-	Structure that contains the Instr. Trans.	-	-
orbit_type	long	-	Define the type of orbit representation, i.e. absolute or relative orbits in the input/output parameters	-	Complete
start_orbit	long	-	First orbit, segment filter. Segments will be filtered as from the beginning of first orbit (within orbit range from orbit_scenario_file) First Orbit in the orbit_scenario_file will be used when: <ul style="list-style-type: none"> <li>Absolute orbit is set to zero.</li> <li>Relative orbit and cycle number set to zero.</li> </ul>	absolute or relative orbit number	= 0 or: <ul style="list-style-type: none"> <li>absolute orbits <math>\geq</math> start_osf</li> <li>relative orbits <math>\leq</math> repeat cycle</li> </ul>
start_cycle	long	-	Cycle number corresponding to the start_orbit. Dummy when using relative orbits	cycle number	= 0 or $\leq$ first cycle in osf
stop_orbit	long	-	Last orbit, segment filter. When: <ul style="list-style-type: none"> <li>stop_orbit = 0 (for orbit_type = XV_ORBIT_ABS)</li> <li>stop_orbit = 0 and stop_cycle = 0 (for orbit_type = XV_ORBIT_REL)</li> </ul> the stop_orbit will be set to the minimum value between: <ul style="list-style-type: none"> <li>the last orbit within the orbital change of the start_orbit.</li> <li>start_orbit+cycle_length-1 (i.e. the input orbit range will be a complete cycle)</li> </ul>	absolute or relative orbit number	= 0 or: <ul style="list-style-type: none"> <li>absolute orbits <math>\geq</math> start_osf</li> <li>relative orbits <math>\leq</math> repeat cycle</li> </ul>

**Table 12: Input parameters of xv\_drs\_vis\_time**

c name	c type	Array Element	Description	Units	Range
stop_cycle	long	-	Cycle number corresponding to the stop_orbit. Dummy when using relative orbits	cycle number	= 0 or $\leq$ first cycle in osf
longitude	double		longitude of data relay satellite		[0, 360]
min_duration	double		Minimum duration for segments. Only segments with a duration longer than min_duration will be given on output.	s	$\geq 0.0$

### 7.3.4 Output parameters

**Table 13: Output parameters of xv\_drs\_vis\_time function**

c name	c type	Array Element	Description	Unit	Range
xv_drs_vis_time	long		Function status flag, = 0 No error > 0 Warnings, results generated < 0 Error, no results generated		
number_segments	long		Number of visibility segments returned to the user		≥ 0
bgn_orbit	long*	all	Orbit number, begin of visibility segment i bgn_orbit[i-1], i = 1, number_segments		> 0
bgn_second	long*	all	Seconds since ascending node, begin of visibility segment i bgn_second[i-1], i = 1, number_segments	s	≥ 0 < orbital period
bgn_microsec	long*	all	Micro seconds within second begin of visibility segment i bgn_microsec[i-1], i = 1, number_segments	ms	≥ 0 ≤ 999999
bgn_cycle	long*	all	Cycle number, begin of visibility segment i bgn_cycle[i-1], i = 1, number_segments		> 0 NULL when using absolute orbits
end_orbit	long*	all	Orbit number, end of visibility segment i end_orbit[i-1], i = 1, number_segments		> 0
end_second	long*	all	Seconds since ascending node, end of visibility segment i end_second[i-1], i = 1, number_segments	s	≥ 0 < orbital period
end_microsec	long*	all	Micro seconds within second end of visibility segment i end_microsec[i-1], i = 1, number_segments	ms	≥ 0 ≤ 999999

**Table 13: Output parameters of xv\_drs\_vis\_time function**

c name	c type	Array Element	Description	Unit	Range
end_cycle	long*	all	Cycle number, begin of visibility segment i bgn_cycle[i-1], i = 1, number_segments		>0 NULL when using absolute orbits
ierr[XV_NUM_ERR_DRS_VIS_TIME]	long		Error status flags		

Memory Management: Note that the output visibility segments arrays are pointers to integers instead of static arrays. The memory for these dynamic arrays is allocated within the **xv\_drs\_vis\_time** function. So the user will only have to declare those pointers but not to allocate memory for them. However, once the function has returned without error, the user will have the responsibility of freeing the memory for those pointers once they are not used.

### 7.3.5 Warnings and errors

Next table lists the possible error messages that can be returned by the **xv\_drs\_vis\_time** CFI function after translating the returned status vector into the equivalent list of error messages by calling the function of the EXPLORER\_VISIBILITY software library **xv\_get\_msg**.

This table also indicates the type of message returned, i.e. either a warning (WARN) or an error (ERR), the cause of such a message and the impact on the performed calculation, mainly on the results vector.

The table is completed by the error code and value. These error codes can be obtained translating the status vector returned by the **xv\_drs\_vis\_time** CFI function by calling the function of the EXPLORER\_VISIBILITY software library **xv\_get\_code**.

Error type	Error message	Cause and impact	Error Code	Error No
ERR	Wrong input orbit Id.	Computation not performed	XV_CFI_DRS_VIS_TIME_ORBIT_STATUS_ERR	0
ERR	Error in absolute start orbit computation.	Computation not performed	XV_CFI_DRS_VIS_TIME_REL_TO_ABS_START_ERR	1
ERR	Error in absolute stop orbit computation.	Computation not performed	XV_CFI_DRS_VIS_TIME_REL_TO_ABS_STOP_ERR	2
WARN	Input "start_orbit" below first OSF orbit: take first OSF orbit for computations.	Computation performed Message to inform the user	XV_CFI_DRS_VIS_TIME_START_ORBIT_WARN	3
ERR	Input "start_orbit" after last OSF orbit.	Computation not performed	XV_CFI_DRS_VIS_TIME_START_ORBIT_OUT_OSF_ERR	4
WARN	Input "stop_orbit" after last OSF orbit: take last OSF orbit for computations.	Computation performed Message to inform the user	XV_CFI_DRS_VIS_TIME_STOP_ORBIT_WARN	5
ERR	Input "stop_orbit" below first OSF orbit.	Computation not performed	XV_CFI_DRS_VIS_TIME_STOP_ORBIT_OUT_OSF_ERR	6
ERR	Error performing a time transformation.	Computation not performed	XV_CFI_DRS_VIS_TIME_TIME_CHANGE_ERR	7
ERR	Error transforming from TAI to TDB time.	Computation not performed	XV_CFI_DRS_VIS_TIME_TAI_TO_TDB_ERR	8
ERR	Error in XL_Sun computation.	Computation not performed	XV_CFI_DRS_VIS_TIME_XL_SUN_ERR	9
WARN	Error allocating internal memory.	Computation performed Message to inform the user	XV_CFI_DRS_VIS_TIME_INTERNAL_MEMORY_ERR	10
ERR	Error allocating memory for the time segments.	Computation not performed	XV_CFI_DRS_VIS_TIME_SEGMENTS_MEMORY_ERR	11
ERR	Error transforming absolute to relative begin segments.	Computation not performed	XV_CFI_DRS_VIS_TIME_ABS_TO_REL_BGN_ERR	12
ERR	Error transforming absolute to relative end segments.	Computation not performed	XV_CFI_DRS_VIS_TIME_ABS_TO_REL_END_ERR	13

Error type	Error message	Cause and impact	Error Code	Error No
ERR	Error in XL_Pt_Dir_Range computation. Orbit no: (%ld). [XL]	Computation not performed	XV_CFI_DRS_VIS_TIME_XL_PT_DIR_RANGE_ERR	14
ERR	Error in state vector computation. Orbit no: (%ld). [PO]	Computation not performed	XV_CFI_DRS_VIS_TIME_XO_EXPLORER_PREDICT_ERR	15
ERR	Error in rectifying Earth rotation. Orbit no: (%ld). [PG]	Computation not performed	XV_CFI_DRS_VIS_TIME_XL_EF_TO_QEF_ERR	16
ERR	Error in coordinates transformation. Orbit no: (%ld). [PL]	Computation not performed	XV_CFI_DRS_VIS_TIME_XL_CHANGE_CS_ERR	17
ERR	Error in Sun direction computation. Orbit no: (%ld). [PL]	Computation not performed	XV_CFI_DRS_VIS_TIME_DIR_SUN_ERR	18
ERR	Error in azimuth-elevation computation. Orbit no: (%ld).	Computation not performed	XV_CFI_DRS_VIS_TIME_XV_CFI_AZIM_ELEV_ERR	19
WARN	Error in physical mask checking. Orbit no: (%ld).	Computation performed Message to inform the user	XV_CFI_DRS_VIS_TIME_XV_CFI_FIXED_CHECK_ERR	20
ERR	Error in Earth occultation checking. Orbit no: (%ld).	Computation not performed	XV_CFI_DRS_VIS_TIME_XV_CFI_EARTH_CHECK_ERR	21
ERR	Error in solar panel position computation. Orbit no: (%ld).	Computation not performed	XV_CFI_DRS_VIS_TIME_XV_CFI_ROTATING_POS_ERR	22
ERR	Error in solar panel occultation checking. Orbit no: (%ld).	Computation not performed	XV_CFI_DRS_VIS_TIME_XV_CFI_ROTATING_SOLAR_PANEL_CHECK_ERR	23
ERR	Error in solar panel structure occultation checking. Orbit no: (%ld).	Computation not performed	XV_CFI_DRS_VIS_TIME_XV_CFI_ROTATING_SOLAR_PANEL_STR_CHECK_ERR	24
ERR	Error in OSF reading.	Computation not performed	XV_CFI_DRS_VIS_TIME_XO_LOAD_GLOBAL_OSF_ERR	25
ERR	Error in input parameters.	Computation not performed	XV_CFI_DRS_VIS_TIME_XV_CFI_DRSINPUTS_CHECK_ERR	26
ERR	Error in canonical position computation. Orbit no: (%ld).	Computation not performed	XV_CFI_DRS_VIS_TIME_XV_CFI_CANON_POS_ERR	27
ERR	Error in orbit parameters computation. Orbit no: (%ld).	Computation not performed	XV_CFI_DRS_VIS_TIME_XV_CFI_ORBIT_INFO_ERR	28
ERR	Error in ascending node parameters computation. Orbit no: (%ld). [PG]	Computation not performed	XV_CFI_DRS_VIS_TIME_XO_GENSTATE_ERR	29
ERR	Maximum number of iterations. Orbit no: (%ld).	Computation performed Message to inform the user	XV_CFI_DRS_VIS_TIME_MAX_NUMBER_ITER_ERR	30

Error type	Error message	Cause and impact	Error Code	Error No
ERR	Error in time computations. Orbit no: (%ld).	Computation not performed	XV_DRS_VIS_TIME_XV_TIME_SEC_ERR	31
WARN	First orbit starts with visibility.	Computation performed Message to inform the user	XV_DRS_VIS_TIME_FIRST_ORBIT_VIS_WARN	32
ERR	Last orbit ends with visibility.	Computation not performed	XV_DRS_VIS_TIME_LAST_ORBIT_VIS_WARN	33
ERR	Error in antenna stop trajectory computations. Orbit no: %ld.	Computation not performed	XV_DRS_VIS_TIME_XV_CHECK_STOP_TRAJECTORY_ERR	34
WARN	No possible stop trajectory. Orbit no: %ld.	Computation performed Message to inform the user	XV_DRS_VIS_TIME_XV_CHECK_STOP_TRAJECTORY_WARN	35
ERR	Error in antenna start-up trajectory computations. Orbit no: %ld.	Computation not performed	XV_DRS_VIS_TIME_XV_CHECK_STARTUP_TRAJECTORY_ERR	36
WARN	No possible start-up trajectory. Orbit no: %ld.	Computation performed Message to inform the user	XV_DRS_VIS_TIME_XV_CHECK_STARTUP_TRAJECTORY_WARN	37



---

### ***7.3.6 Runtime performances***

The following runtime performance has been measured.

*Table 14: Runtime performances of xv\_drs\_vis\_time function*

Ultra Sparc [ms]
TBD

## 7.4 xv\_swath\_pos

### 7.4.1 Overview

The **xv\_swath\_pos** function computes the location of a swath at a given time.

Swath location is expressed as<sup>1</sup>:

- longitude
- latitude
- altitude

for up to 3 points, defined as follows with respect to satellite flight direction (see Figure 2):

- left-most point of the swath
- middle point of the swath
- right-most point of the swath

**xv\_swath\_pos** requires access to several data structures and files to produce its results:

- the `orbit_id` (`xo_orbit_id`) providing the orbital data. The `orbit_id` can be initialized with the following data and files (see [ORBIT\_SUM]):
  - data for an orbital change
  - Orbit scenario files
  - Predicted orbit files
  - Orbit Event Files
  - Restituted orbit files
  - DORIS Preliminary orbit files
  - DORIS Navigator files
- the Instrument Swath data, describing the area seen by the relevant instrument all along the current orbit. The swath file is produced off-line by the EXPLORER\_VISIBILITY library (**xv\_gen\_swath** function) and the data structure can be get by reading the file with **xd\_read\_stf**.

The input time used by **xv\_swath\_pos** is expressed in orbit-relative time.

Users who need to use processing time must make use of the conversion routine provided in EXPLORER\_VISIBILITY (**xv\_time\_to\_orbit** and **xv\_orbit\_to\_time** functions).

**NOTE:** Since the swath template file is generated from a reference orbit, it is not allowed to use **xv\_swath\_pos** for an orbit in the orbit scenario file with different repeat cycle or cycle length. If this would happen, **xv\_swath\_pos** will return an error and no computation will be performed.

1. For inertial swaths, right ascension and declination are used instead of longitude and latitude

## 7.4.2 Calling sequence *xv\_swath\_pos*

For C programs, the call to **xv\_swath\_pos** is (input parameters are underlined):

```
#include "explorer_visibility.h"
{
    xo_orbit_id    orbit_id = {NULL};
    long           orbit_type,
                  orbit, second, microsec, cycle,
                  ierr[XV_NUM_ERR_SWATH_POS], status;
    double         longitude[3], latitude[3], altitude[3];
    xd_stf_file    stf_data;

    status = xv_swath_pos(&orbit_id,
                        &stf_data,
                        &orbit_type,
                        &orbit, &second, &microsec, &cycle,
                        longitude, latitude, altitude,
                        ierr);

    /* Or, using the run_id */
    long run_id;

    status = xv_swath_pos_run(&run_id,
                             &stf_data,
                             &orbit_type,
                             &orbit, &second, &microsec, &cycle,
                             longitude, latitude, altitude,
                             ierr);
}
```

For FORTRAN programs **xv\_swath\_pos** has the following calling sequence (input parameters are underlined, note that the C preprocessor must be used because of the presence of the #include statement):

```
INTEGER*4      SAT_ID, ORBIT_TYPE,
&              ORBIT, SECOND, MICROSEC, CYCLE,
               IERR(XV_NUM_ERR_SWATH_POS), STATUS
REAL*8         LONGITUDE(3), LATITUDE(3), ALTITUDE(3)
CHARACTER*(*)  ORBIT_SCENARIO_FILE
XD_STF_FILE    STF_FILE
```

```
#include "explorer_visibility.inc"
```

```

STATUS = XV_SWATH_POS(SAT_ID, ORBIT_SCENARIO_FILE,
& STF_DATA,
& ORBIT_TYPE,
& ORBIT, SECOND, MICROSEC, CYCLE,
& LONGITUDE, LATITUDE, ALTITUDE,
IERR)
  
```

C test status

### 7.4.3 Input parameters xv\_swath\_pos

Table 15: Input parameters of xv\_swath\_pos

c name	c type	Array Element	Description	Units	Range
orbit_id	xo_orbit_id*	-	Structure that contains the orbit data	-	-
stf_data	xd_stf_file		Swath Template data structure	-	-
orbit_type	long	-	Define the type of orbit representation, i.e. absolute or relative orbits in the input/output parameters	-	Complete
orbit	long		Orbit number		> 0
second	long		Seconds since ascending node	s	>= 0 < orbital period
microsec	long		Micro seconds within second	ms	0 =<=< 999999
cycle	long		Cycle number.		>0

### 7.4.4 Output parameters *xv\_swath\_pos*

**Table 16: Output parameters of *xv\_swath\_pos***

c name	c type	Array Element	Description	Unit	Range
<i>xv_swath_pos</i>	long		Function status flag, = 0 No error > 0 Warnings, results generated < 0 Error, no results generated		
<i>longitude</i> [3]	double	all	<i>longitude</i> (right ascension for inertial swaths) of point <i>i</i> : <i>i</i> = 0, left swath point <i>i</i> = 1, mid swath point <i>i</i> = 2, right swath point In case of point swath, only <i>longitude</i> [0] is useful; <i>longitude</i> [1] and <i>longitude</i> [2] are dummy	deg	[-180, 180]
<i>latitude</i> [3]	double	all	<i>latitude</i> (declination for inertial swaths) of point <i>i</i> : <i>i</i> = 0, left swath point <i>i</i> = 1, mid swath point <i>i</i> = 2, right swath point In case of point swath, only <i>latitude</i> [0] is useful; <i>latitude</i> [1] and <i>latitude</i> [2] are dummy	deg	[-90, 90]
<i>altitude</i> [3]	double	all	<i>altitude</i> of point <i>i</i> : <i>i</i> = 0, left swath point <i>i</i> = 1, mid swath point <i>i</i> = 2, right swath point In case of point swath, only <i>altitude</i> [0] is useful; <i>altitude</i> [1] and <i>altitude</i> [2] are dummy	m	
<i>ierr</i> [XV_NUM_ERR_SWATH_POS]	long		Error status flags		

### 7.4.5 Warnings and errors

Next table lists the possible error messages that can be returned by the **xv\_swath\_pos** CFI function after translating the returned status vector into the equivalent list of error messages by calling the function of the EXPLORER\_VISIBILITY software library **xv\_get\_msg**.

This table also indicates the type of message returned, i.e. either a warning (WARN) or an error (ERR), the cause of such a message and the impact on the performed calculation, mainly on the results vector.

The table is completed by the error code and value. These error codes can be obtained translating the status vector returned by the **xv\_swath\_pos** CFI function by calling the function of the EXPLORER\_VISIBILITY software library **xv\_get\_code**.

Error type	Error message	Cause and impact	Error Code	Error No
ERR	Wrong orbit Id.	Computation not performed	XV_CFI_SWATH_POS_ORBIT_STATUS_ERR	0
ERR	Wrong input Orbit Id. Unknown orbit initialization mode	Computation not performed	XV_CFI_SWATH_POS_ORBIT_MODEL_ERR	1
ERR	Orbital information does not coincide with reference swath.	Computation not performed	XV_CFI_SWATH_POS_INCONSISTENT_SWATH_ERR	2
ERR	Orbit number must be positive.	Computation not performed	XV_CFI_SWATH_POS_ORBIT_NUM_LIM_ERR	3
ERR	Seconds since ascending node must be zero or positive.	Computation not performed	XV_CFI_SWATH_POS_SECONDS_LIM_ERR	4
ERR	MicroSeconds must be zero or positive	Computation not performed	XV_CFI_SWATH_POS_MICROSEC_1ST_ERR	5
ERR	MicroSeconds can not be bigger than 999999.	Computation not performed	XV_CFI_SWATH_POS_MICROSEC_2ND_ERR	6
ERR	Orbit type switch out of range.	Computation not performed	XV_CFI_SWATH_POS_ORBIT_TYPE_ERR	7
ERR	Cycle number must be positive.	Computation not performed	XV_CFI_SWATH_POS_CYCLE_ERR	8
ERR	Orbit number is not included in the Orbit Scenario File	Computation not performed	XV_CFI_SWATH_POS_ORBIT_NUM_OEF_ERR	9
ERR	Seconds since ascending node must be less than orbital period.	Computation not performed	XV_CFI_SWATH_POS_SECONDS_ORB_PER_ERR	10
ERR	Input time greater than orbital period	Computation not performed	XV_CFI_SWATH_POS_TIME_ERR	11
ERR	Repeat Days Cycle of this orbit is not the same than the swath template.	Computation not performed	XV_CFI_SWATH_POS_REPEAT_CYCLE_ERR	12
ERR	Orbits Cycle Length of this orbit is not the same than the swath template	Computation not performed	XV_CFI_SWATH_POS_CYCLE_LENGTH_ERR	13

Error type	Error message	Cause and impact	Error Code	Error No
ERR	MLST drift of this orbit is not the same than the swath template.	Computation not performed	XV_CFI_SWATH_POS_MLS_T_DRIFT_ERR	14
ERR	No spherical triangle.	Computation not performed	XV_CFI_SWATH_POS_SPHER_TRIANG_ERR	15
ERR	Error while transforming from relative to absolute orbit.	Computation not performed	XV_CFI_SWATH_POS_REL_TO_ABS_ERR	16
ERR	Error while reading OSF information.	Computation not performed	XV_CFI_SWATH_POS_XV_OSF_RECORDS_READ_ERR	17
ERR	Error while computing information of the orbit.	Computation not performed	XV_CFI_SWATH_POS_XV_ORBIT_INFO_ERR	18
ERR	Error while reading SWATH FILE.	Computation not performed	XV_CFI_SWATH_POS_XV_SWATH_READ_ERR	19
ERR	The swath template structure contains invalid data	Computation not performed	XV_CFI_SWATH_POS_SWATH_INIT_ERR	20

---

### 7.4.6 Runtime performances

The following runtime performance has been measured.

*Table 17: Runtime performances of xv\_swath\_pos function*

Ultra Sparc [ms]
TBD



## 7.5 xv\_star\_vis\_time

### 7.5.1 Overview

The **xv\_star\_vis\_time** function computes stars visibility segments, the orbital segments for which a given star is visible with a given instrument from the satellite.

An orbital segment is a time interval along the orbit, defined by start and stop times expressed as seconds elapsed since the ascending node crossing.

In addition, **xv\_star\_vis\_time** calculates for every start and end of the visibility segment a coverage flag, determining which side of the FOV the event took place.

**xv\_star\_vis\_time** requires access to several data structures and files to produce its results:

- the orbit\_id (xo\_orbit\_id) providing the orbital data. The orbit\_id can be initialized with the following data or files (see [ORBIT\_SUM]):
  - data for an orbital change
  - Orbit scenario files
  - Predicted orbit files
  - Orbit Event Files
  - Restituted orbit files
  - DORIS Preliminary orbit files
  - DORIS Navigator files
- Two Inertial Reference Swath Files. The Swath data can be provided by:
  - A swath template file produced off-line by the EXPLORER\_VISIBILITY library (**xv\_gen\_swath** function).
  - A swath definition file, describing the swath geometry. In this case the **xv\_star\_vis\_time** generates the swath points for a number of orbits given by the user.
- (*Optional*) The Star's Database File, describing the location in right ascension and declination of a star, described by its corresponding identifier.

The time intervals used by **xv\_star\_vis\_time** are expressed in absolute or relative orbit numbers. This is valid for both:

- input parameter "Orbit Range": first and last orbit to be considered. In case of using relative orbits, the corresponding cycle number should be used, otherwise, this the cycle number will be a dummy parameter.
- output parameter "Star Visibility Segments": time segments with time expressed as {absolute orbit number (or relative orbit and cycle number), number of seconds since ANX, number of microseconds}

The orbit representation (absolute or relative) for the output segments will be the same as in the input orbits. Moreover, the segments will be ordered chronologically.

Users who need to use processing times must make use of the conversion routines provided in EXPLORER\_VISIBILITY (**xv\_time\_to\_orbit** and **xv\_orbit\_to\_time** functions).

## 7.5.2 Swath Definition

**xv\_star\_vis\_time** calculates stars visibility segments for FOV corresponding to limb-sounding instruments observing inertial objects. The corresponding template files are generated off-line by the EXPLORER\_VISIBILITY CFI software (**xv\_gen\_swath** function).

### 7.5.2.1 Inertial Swaths

The FOV for a Limb-sounding instrument observing inertial objects is calculated using two main parameters.

- The FOV projection on the celestial sphere is determined by two set of swaths, one corresponding to a higher (TOP) and a lower (BOTTOM) altitude over the ellipsoid, hence defining the elevation range of the FOV
- The azimuth range is defined as such, the extremes corresponding to the left and right sides. In addition **xv\_gen\_swath** generates coordinates for a middle point

**Figure 10 Two tangent altitudes over the ellipsoid**

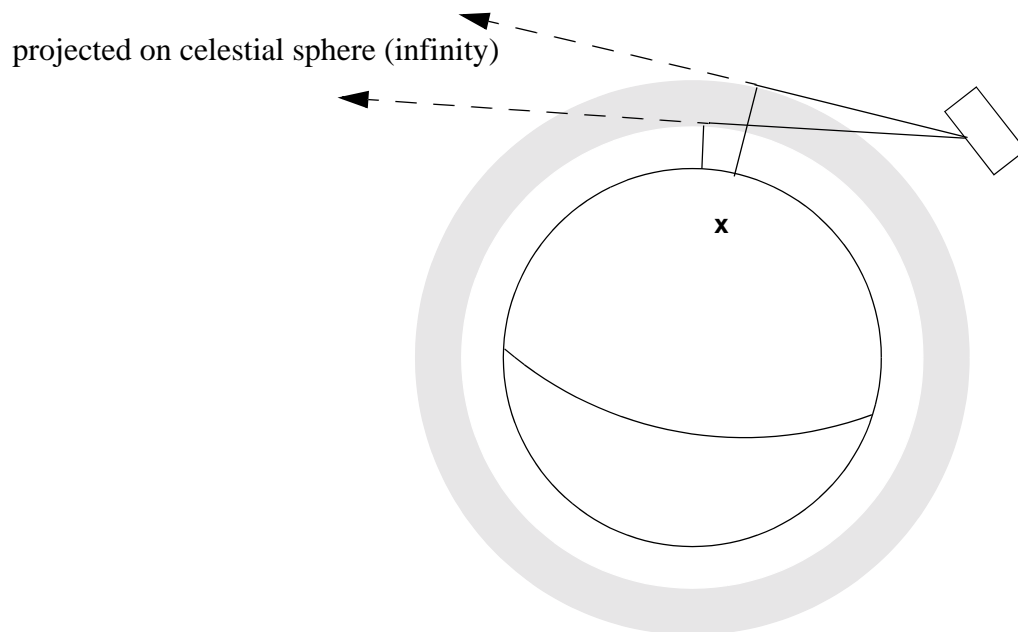

The instantaneous FOV projected on the celestial sphere can be represented as a series of points defined by their Right Ascension and Declination coordinates.

The top and bottom lines sweep the azimuth range at a constant tangent altitude, whilst the left and right side have a constant azimuth value with changing tangent altitude.

The shape of FOV should be similar to that shown in the diagram below with the dotted lines, whilst the algorithm implemented in **xv\_star\_vis\_time** uses a simplified model joining the points with straight line.

As the satellite evolves around the orbit and the FOV sweeps the celestial sphere, a star can enter the FOV. **xv\_star\_vis\_time** calculates that time and returns a flag indicating which part of the FOV (*LEFT*, *TOP*, *RIGHT* or *BOTTOM*) first detected the star. The same is done when the star exits the FOV.

**Figure 11 Instantaneous FOV projected on the celestial sphere**

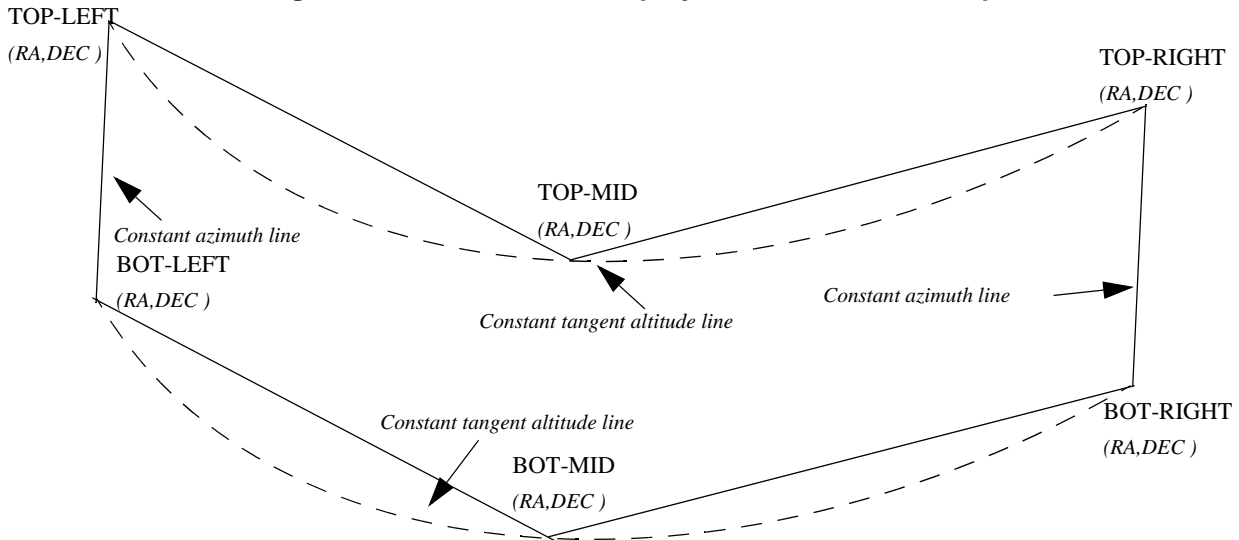

### 7.5.2.2 Splitting swaths

As it was shown in *figure 11*, the accuracy and precision of **xv\_star\_vis\_time** strongly depends on how close the projection used in the algorithm is to the real world. Higher accuracy can be obtained splitting the azimuth range in sub-swaths.

Furthermore, splitting the swath would be necessary if the FOV was to cover an azimuth range larger than 180 degrees.

Note: It is important to note that if the FOV covers the value of 90 or 270 degrees in azimuth, one of the extremes (*LEFT* or *RIGHT*) of the STF must correspond to that azimuth value.

### 7.5.2.3 Orbital Changes

Since the reference swath template file is generated from a reference orbit, it is not recommended to use **xv\_star\_vis\_time** for a range of orbits that includes an orbital change (e.g. change in the repeat cycle or cycle length). If this would happen, **xv\_star\_vis\_time** will automatically ignore those orbits from the orbital change onwards, i.e. the actual stop orbit shall be the previous one to the first change in repeat cycle or cycle length.

### 7.5.3 Calling sequence *xv\_star\_vis\_time*

For C programs, the call to **xv\_star\_vis\_time** is (input parameters are underlined):

```
#include "explorer_visibility.h"
{
    xo_orbit_id    orbit_id = {NULL};
    long           swath_flag, orbit_type,
                  start_orbit, start_cycle,
                  stop_orbit, stop_cycle,
                  number_segments,
                  *bgn_orbit, *bgn_second, *bgn_microsec,
                  *bgn_cycle, *bgn_coverage,
                  *end_orbit, *end_second, *end_microsec,
                  *end_cycle, *end_coverage,
                  ierr[XV_NUM_ERR_STAR_VIS_TIME], status;
    double        star_ra, star_dec, star_ra_deg, star_dec_deg,
                  min_duration;
    char          *orbit_scenario_file,
                  *swath_file_upper, *swath_file_lower;
    char          star_id[8], *star_db_file;

    status = xv_star_vis_time(
        &orbit_id, &orbit_type,
        &start_orbit, &start_cycle,
        &stop_orbit, &stop_cycle,
        &swath_flag, swath_file_upper, swath_file_lower,
        star_id, star_db_file,
        &star_ra, &star_dec,
        &min_duration,
        &star_ra_deg, &star_dec_deg,
        &number_segments,
        &bgn_orbit, &bgn_second, &bgn_microsec,
        &bgn_cycle, &bgn_coverage,
        &end_orbit, &end_second, &end_microsec,
        &end_cycle, &end_coverage,
        ierr);

    /* Or, using the run_id */
    long run_id;

    status = xv_star_vis_time_run(
        &run_id, &orbit_type,
        &start_orbit, &start_cycle,
        &stop_orbit, &stop_cycle,
        &swath_flag, swath_file_upper, swath_file_lower,
        star_id, star_db_file,
        &star_ra, &star_dec,
        &min_duration,
```

```

        &star_ra_deg, &star_dec_deg,
        &number_segments,
        &bgn_orbit, &bgn_second, &bgn_microsec,
        &bgn_cycle, &bgn_coverage,
        &end_orbit, &end_second, &end_microsec,
        &end_cycle, &end_coverage,
        ierr);
}

```

For FORTRAN programs **xv\_star\_vis\_time** has the following calling sequence (input parameters are underlined, note that the C preprocessor must be used because of the presence of the #include statement):

```

    INTEGER*4    SAT_ID, ORBIT_TYPE,
&              START_ORBIT, START_CYCLE,
&              STOP_ORBIT, STOP_CYCLE,
&              NUMBER_SEGMENTS,
&              BGN_ORBIT(MAX_SEGMENTS),
&              BGN_SECOND(MAX_SEGMENTS),
&              BGN_MICROSEC(MAX_SEGMENTS),
&              BGN_CYCLE(MAX_SEGMENTS),
&              BGN_COVERAGE(MAX_SEGMENTS),
&              END_ORBIT(MAX_SEGMENTS),
&              END_SECOND(MAX_SEGMENTS),
&              END_MICROSEC(MAX_SEGMENTS),
&              END_CYCLE(MAX_SEGMENTS),
&              END_COVERAGE(MAX_SEGMENTS),
&              IERR(XV_NUM_ERR_STAR_VIS_TIME), STAUTS;
    REAL*8      STAR_RA, STAR_DEC, STAR_RA_DEG,
&              STAR_DEC_DEG, MIN_DURATION
    CHARACTER*(*)ORBIT_SCENARIO_FILE, STAR_DB_FILE
&              SWATH_FILE_UPPER, SWATH_FILE_LOWER
    CHARACTER*8 STAR_ID

```

```
#include"explorer_visibility.inc"
```

```

    STATUS = XV_STAR_VIS_TIME(
&              SAT_ID, ORBIT_SCENARIO_FILE, ORBIT_TYPE,
&              START_ORBIT, START_CYCLE,
&              STOP_ORBIT, STOP_CYCLE,
&              SWATH_FILE_UPPER, SWATH_FILE_LOWER,
&              STAR_ID, STAR_DB_FILE,
&              STAR_RA, STAR_DEC,
&              MIN_DURATION,
&              STAR_RA_DEG, STAR_DEC_DEG,
&              NUMBER_SEGMENTS,
&              BGN_ORBIT, BGN_SECOND, BGN_MICROSEC,
&              BGN_CYCLE, BGN_COVERAGE,
&              END_ORBIT, END_SECOND, END_MICROSEC,
&              END_CYCLE, END_COVERAGE,
&              IERR);

```

### 7.5.4 Input parameters *xv\_star\_vis\_time*

**Table 18: Input parameters of *xv\_star\_vis\_time***

c name	c type	Array Element	Description	Units	Range
orbit_id	xo_orbit_id*	-	Structure that contains the orbit data	-	-
orbit_type	long	-	Define the type of orbit representation, i.e. absolute or relative orbits in the input/output parameters	-	Complete
start_orbit	long	-	First orbit, segment filter. Segments will be filtered as from the beginning of first orbit (within orbit range from orbit_scenario_file) If set to zero then first orbit of orbit_scenario_file is selected.	absolute or relative orbit number	= 0 or: absolute orbits $\geq$ start_osf relative orbits $\leq$ repeat cycle
start_cycle	long	-	Cycle number corresponding to the start_orbit. Dummy when using relative orbits	cycle number	= 0 or $\geq$ start_osf
stop_orbit	long	-	Last orbit, segment filter. When: <ul style="list-style-type: none"> <li>• stop_orbit = 0 (for orbit_type = XV_ORBIT_ABS)</li> <li>• stop_orbit = 0 and stop_cycle = 0 (for orbit_type = XV_ORBIT_REL)</li> </ul> the stop_orbit will be set to the minimum value between: <ul style="list-style-type: none"> <li>• the last orbit within the orbital change of the start_orbit. start_orbit+cycle_length-1 (i.e. the input orbit range will be a complete cycle)</li> </ul>	absolute or relative orbit number	= 0 or: absolute orbits $\geq$ start_osf relative orbits $\leq$ repeat cycle
stop_cycle	long	-	Cycle number corresponding to the stop_orbit. Dummy when using relative orbits	cycle number	=0 or $\geq$ start_osf

**Table 18: Input parameters of xv\_star\_vis\_time**

c name	c type	Array Element	Description	Units	Range
swath_flag	long*	-	Define the use of the swath file: <ul style="list-style-type: none"> <li>• 0 = (XV_STF) if the swath file is a swath template file.</li> <li>• &gt; 0 if the swath files is a swath definition file. In this case the swath points are generated for every "swath_flag" orbits</li> </ul>	-	XV_STF = 0 XV_SDF = 1 > 0
swath_file_upper	char *		File name of the inertial swath-file for the appropriate instrument mode, which defines the upper limit of the FOV. This file is read each time the function is called		
swath_file_lower	char *		File name of the inertial swath-file for the appropriate instrument mode, which defines the lower limit of the FOV. This file is read each time the function is called		
star_id[8]	char		identification of the star, as defined in the star_db_file. This parameter is used <b>ONLY IF</b> star_db_file is not equal empty string(“”)		EXACTLY 8 characters
star_db_file	char *		File name of the star database file		
star_ra	double*		Right Ascension of Star, in TOD. This parameter is used <b>ONLY IF</b> star_db_file is equal empty string(“”)	deg	(-180.0, 180.0)
star_dec	double*		Declination of Star, in TOD. This parameter is used <b>ONLY IF</b> star_db_file is equal empty string(“”)	deg	(-90.0, 90.0)
min_duration	double*		Minimum duration for segments. Only segments with a duration longer than min_duration will be given on output.	s	≥ 0.0

### 7.5.5 Output parameters *xv\_star\_vis\_time*

**Table 19: Output Parameters of *xv\_star\_vis\_time***

c name	c type	Array Element	Description	Unit	Range
<i>xv_star_vis_time</i>	long		Function status flag, = 0 No error > 0 Warnings, results generated < 0 Error, no results generated		
<i>star_ra_deg</i>	double		Right Ascension of the star, in TOD, for the UTC halfway <i>start_orbit</i> and <i>stop_orbit</i> .	deg	(-180.0, 180.0)
<i>star_dec_deg</i>	double		Declination of the star, in TOD, for the UTC halfway <i>start_orbit</i> and <i>stop_orbit</i> .	deg	(-90.0, 90.0)
<i>number_segment</i>	long		Number of visibility segments returned to the user		≥ 0
<i>bgn_orbit</i>	long*	all	Orbit number, begin of visibility segment <i>i</i> <i>bgn_orbit</i> [ <i>i</i> -1], <i>i</i> = 1, <i>number_segments</i>		> 0
<i>bgn_second</i>	long*	all	Seconds since ascending node, begin of visibility segment <i>i</i> <i>bgn_second</i> [ <i>i</i> -1], <i>i</i> = 1, <i>number_segments</i>	s	≥ 0 < orbital period
<i>bgn_microsec</i>	long*	all	Micro seconds within second begin of visibility segment <i>i</i> <i>bgn_microsec</i> [ <i>i</i> -1], <i>i</i> = 1, <i>number_segments</i>	μs	≥ 0 ≤ 999999
<i>bgn_cycle</i>	long*	all	cycle number begin of visibility segment <i>i</i> <i>bgn_microsec</i> [ <i>i</i> -1], <i>i</i> = 1, <i>number_segments</i>		> 0 NULL when using relative orbits
<i>bgn_coverage</i>	long*	all	Coverage flag for swath entry: XV_STAR_UNDEFINED = 0, XV_STAR_UPPER = 1, XV_STAR_LOWER = 2, XV_START_LEFT = 3, XV_STAR_RIGHT=4		0,1,2,3,4



**Table 19: Output Parameters of xv\_star\_vis\_time**

c name	c type	Array Element	Description	Unit	Range
end_orbit	long*	all	Orbit number, end of visibility segment i end_orbit[i-1], i = 1, number_segments		> 0
end_second	long*	all	Seconds since ascending node, end of visibility segment i end_second[i-1], i = 1, number_segments	s	≥ 0 <orbital period
end_microsec	long*	all	Micro seconds within second end of visibility segment i end_microsec[i-1], i = 1, number_segments	μs	0 ≤ 999999
end_cycle	long*	all	End cycle, end of visibility segment i end_orbit[i-1], i = 1, number_segments		>0 NULL when using relative orbits
end_coverage	long*	all	Coverage flag for swath exit: XV_STAR_UNDEFINED = 0, XV_STAR_UPPER = 1, XV_STAR_LOWER = 2, XV_START_LEFT = 3, XV_STAR_RIGHT=4		0,1,2,3,4
ierr[10]	long		Error status flags		

**Memory Management:** Note that the output visibility segments arrays are pointers to integers instead of static arrays. The memory for these dynamic arrays is allocated within the **xv\_star\_vis\_time** function. So the user will only have to declare those pointers but not to allocate memory for them. However, once the function has returned without error, the user will have the responsibility of freeing the memory for those pointers once they are not used.

### 7.5.6 Warnings and errors

Next table lists the possible error messages that can be returned by the **xv\_star\_vis\_time** CFI function after translating the returned status vector into the equivalent list of error messages by calling the function of the EXPLORER\_VISIBILITY software library **xv\_get\_msg**.

This table also indicates the type of message returned, i.e. either a warning (WARN) or an error (ERR), the cause of such a message and the impact on the performed calculation, mainly on the results vector.

The table is completed by the error code and value. These error codes can be obtained translating the status vector returned by the **xv\_star\_vis\_time** CFI function by calling the function of the EXPLORER\_VISIBILITY software library **xv\_get\_code**.

Error type	Error message	Cause and impact	Error Code	Error No
ERR	Error, wrong orbit Id.	Computation not performed	XV_CFI_STAR_VIS_TIME_ORBIT_STATUS_ERR	0
ERR	Error while transforming into absolute orbit the start_orbit.	Computation not performed	XV_CFI_STAR_VIS_TIME_REL_TO_ABS_START_ERR	1
ERR	Error while transforming into absolute orbit the stop_orbit.	Computation not performed	XV_CFI_STAR_VIS_TIME_REL_TO_ABS_STOP_ERR	2
ERR	Error allocating internal memory.	Computation not performed	XV_CFI_STAR_VIS_TIME_INTERNAL_MEMORY_ERR	3
ERR	Error allocating memory for the visibility segments.	Computation not performed	XV_CFI_STAR_VIS_TIME_SEGMENTS_MEMORY_ERR	4
ERR	Error allocating memory for the coverage.	Computation not performed	XV_CFI_STAR_VIS_TIME_COVERAGE_MEMORY_ERR	5
ERR	Error while transforming into relative orbits the output segments.	Computation not performed	XV_CFI_STAR_VIS_TIME_ABS_TO_REL_ERR	6
ERR	Error in input parameter to starvstime.	Computation not performed	XV_CFI_STAR_VIS_TIME_INPUTS_CHECK_ERR	7
ERR	Error reading the Orbit event file.	Computation not performed	XV_CFI_STAR_VIS_TIME_ORBIT_SF_READ_ERR	8
WARN	Warning, start orbit is outside range of OEF/OSF.	Computation performed Message to inform the user	XV_CFI_STAR_VIS_TIME_FIRST_ORBIT_WARN	9
WARN	Warning, stop orbit is outside range of OEF/OSF.	Computation performed Message to inform the user	XV_CFI_STAR_VIS_TIME_LAST_ORBIT_WARN	10
ERR	Error updating star's position in from JD2000 to determined UTC.	Computation not performed	XV_CFI_STAR_VIS_TIME_STAR_RADEC_ERR	11
ERR	Error obtaining orbital information.	Computation not performed	XV_CFI_STAR_VIS_TIME_ORBIT_INFO_ERR	12
WARN	Warning, there is an orbital change within the requested orbits.	Computation performed Message to inform the user	XV_CFI_STAR_VIS_TIME_ORBIT_CHANGE_WARN	13

Error type	Error message	Cause and impact	Error Code	Error No
ERR	Error reading the upper swath template file.	Computation not performed	XV_CFI_STAR_VIS_TIME_SWATH_UPPER_READ_ERR	14
ERR	Error reading the lower swath template file.	Computation not performed	XV_CFI_STAR_VIS_TIME_SWATH_LOWER_READ_ERR	15
ERR	Error, starvistime can only operate with an inertial swath.	Computation not performed	XV_CFI_STAR_VIS_TIME_INERTIAL_SWATH_ERR	16
ERR	Error, Orbital information does not coincide with reference swath.	Computation not performed	XV_CFI_STAR_VIS_TIME_INCONSISTENT_SWATH_ERR	17
ERR	Error reading the star data file.	Computation not performed	XV_CFI_STAR_VIS_TIME_READ_STAR_ERR	18
ERR	Low swath altitude is above the upper limit described by the higher swath altitude.	Computation not performed	XV_CFI_STAR_VIS_TIME_ALT_ERR	19
ERR	Error determining transitions.	Computation not performed	XV_CFI_STAR_VIS_TIME_START_MAIN_ERR	20

---

### ***7.5.7 Runtime performances***

The following runtime performance has been measured.

*Table 20: Runtime performances of xv\_swath\_pos function*

Ultra Sparc [ms]
TBD

## 7.6 xv\_multizones\_vis\_time

### 7.6.1 Overview

The **xv\_multizones\_vis\_time** function computes all the orbital segments for which a given instrument swath intercepts several user-defined zones at the surface of the Earth ellipsoid.

The visibility segments are obtained by calling to **xv\_zone\_vis\_time** (see section 7.1 for further details about swaths, zones and visibility segments definitions). Those segments are merged and ordered by start time. In addition to this, two tables are provided. The first one contains the zones where segment has visibility, and the second one contains the coverage of the segment for each zone (see figure 12).

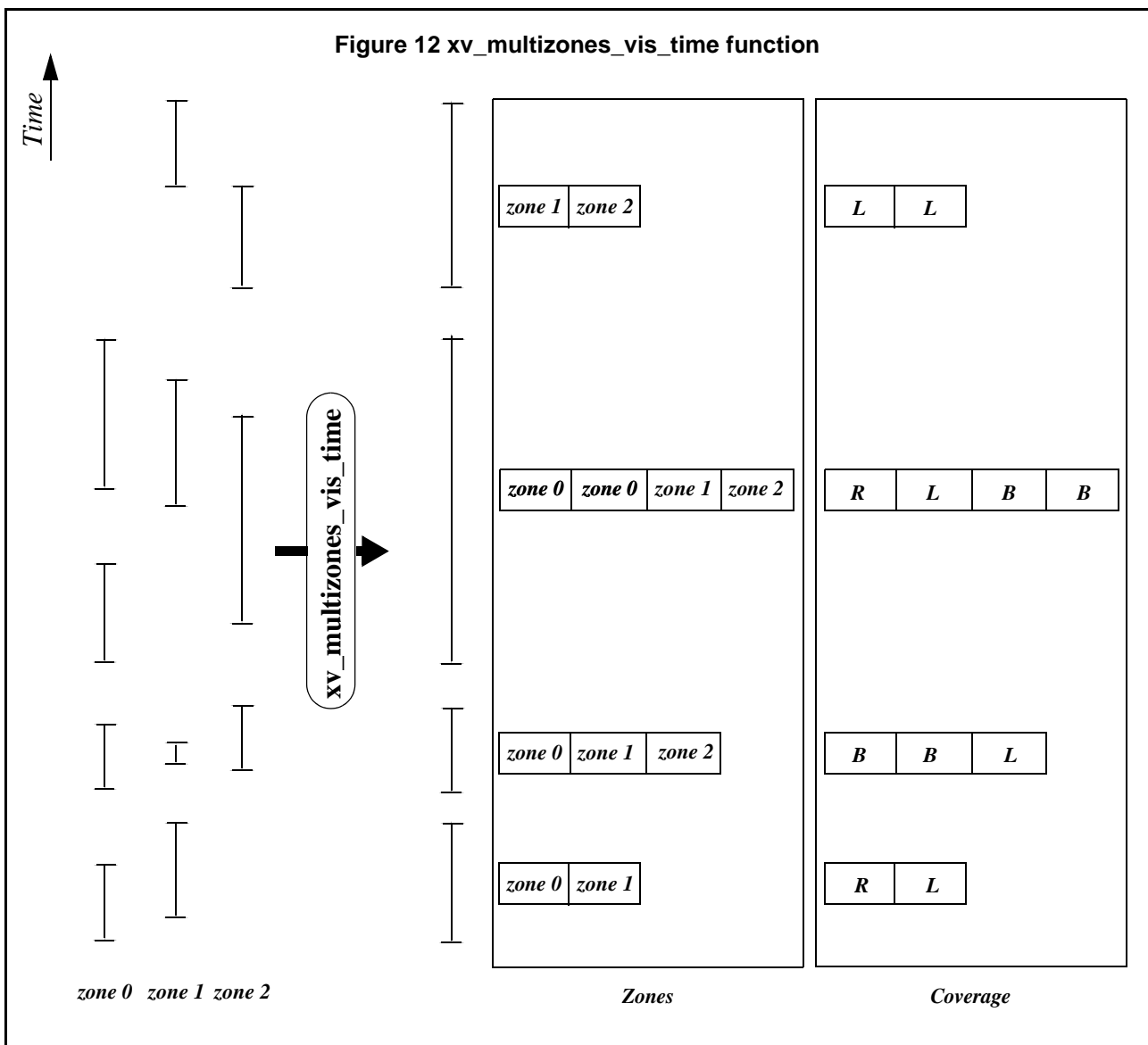

The time intervals used by **xv\_multizones\_vis\_time** are expressed in absolute orbit numbers or in relative orbit and cycle numbers. This is valid for both:

- input parameter “Orbit Range”: first and last orbit to be considered. In case of using relative orbits, the corresponding cycle number should be used, otherwise, this the cycle number will be a dummy parameter.
- output parameter “Zone Visibility Segments”: time segments with time expressed as {absolute orbit number (or relative orbit number and cycle number), number of seconds since ascending node, number of microseconds}

The orbit representation (absolute or relative) for the output segments will be the same as in the input orbits.

**xv\_multizones\_vis\_time** requires access to several data structures and files to produce its results:

- the orbit\_id (xo\_orbit\_id) providing the orbital data. The orbit\_id can be initialized with the following data or files (see [ORBIT\_SUM]):
  - data for an orbital change
  - Orbit scenario files
  - Predicted orbit files
  - Orbit Event Files
  - Restituted orbit files
  - DORIS Preliminary orbit files
  - DORIS Navigator files
- the Instrument Swath File, excluding inertial swath files, describing the area seen by the relevant instrument all along the current orbit. The Swath data can be provided by:
  - A swath template file produced off-line by the EXPLORER\_VISIBILITY library (**xv\_gen\_swath** function).
  - A swath definition file, describing the swath geometry. In this case the **xv\_multizones\_vis\_time** generates the swath points for a number of orbits given by the user.
- optionally, a Zone Database File, containing the zone description. The user can either specify a zone identifier referring to a zone in the file, or provide the zone parameters directly to **xv\_multizones\_vis\_time**.

Users who need to use processing times must make use of the conversion routines provided in EXPLORER\_ORBIT (**xo\_time\_to\_orbit** and **xo\_orbit\_to\_time** functions).

**NOTE:** Since the swath template file is generated from a reference orbit, it is not recommended to use **xv\_multizones\_vis\_time** for a range of orbits that includes an orbital change (e.g. change in the repeat cycle or cycle length). If this would happen, **xv\_multizones\_vis\_time** automatically will ignore those orbits that do not correspond with the template file (i.e. no visibility segments will be generated for those orbits).

## 7.6.2 Calling sequence *xv\_multizones\_vis\_time*

For C programs, the call to **xv\_multizones\_vis\_time** is (input parameters are underlined):

```
#include "explorer_visibility.h"
{

    xo_orbit_id  orbit_id = {NULL};
    long        swath_flag, orbit_type,
               start_orbit, start_cycle, stop_orbit, stop_cycle,
               num_zones, projection, *zone_num,
               extra_info_flag,
               number_segments,
               *bgn_orbit, *bgn_secs, *bgn_microsecs, *bgn_cycle,
               *end_orbit, *end_secs, *end_microsecs, *end_cycle,
               *nb_zon_in_segment, **zones_in_segment, **coverage,
               ierr[XV_NUM_ERR_MULTIZONES_VIS_TIME], status;

    double      *zone_long, *zone_lat, *zone_diam,
               min_duration;

    char        *swath_file, *zone_db_file,
               **zone_id;

    status = xv_multizones_vis_time(
               &orbit_id, &orbit_type,
               &start_orbit, &start_cycle,
               &stop_orbit, &stop_cycle,
               &swath_flag, swath_file, &num_zones,
               zone_id, zone_db_file,
               projection, zone_num,
               zone_long, zone_lat, zone_diam,
               &min_duration, &extra_info_flag,
               &number_segments,
               &bgn_orbit, &bgn_second, &bgn_microsec, &bgn_cycle,
               &end_orbit, &end_second, &end_microsec, &end_cycle,
               &nb_zon_in_segment, &zones_in_segment, &coverage,
               ierr);

    /* Or, using the run_id */
    long run_id;

    status = xv_multizones_vis_time_run(
               &run_id, &orbit_type,
               &start_orbit, &start_cycle,
               &stop_orbit, &stop_cycle,
               &swath_flag, swath_file, &num_zones,
               zone_id, zone_db_file,
```

```

    projection, zone_num,
    zone_long, zone_lat, zone_diam,
    &min_duration, &extra_info_flag,
    &number_segments,
    &bgn_orbit, &bgn_second, &bgn_microsec, &bgn_cycle,
    &end_orbit, &end_second, &end_microsec, &end_cycle,
    &nb_zon_in_segment, &zones_in_segment, &coverage,
    ierr);
}

```

For FORTRAN programs **xv\_multizones\_vis\_time** has the following calling sequence (input parameters are underlined, note that the C preprocessor must be used because of the presence of the #include statement):

```

    INTEGER*4    SAT_ID, ORBIT_TYPE,
    &            START_ORBIT, START_CYCLE, STOP_ORBIT, STOP_CYCLE,
    &            NUM_ZONES(MAX_ZONES), PROJECTION(MAX_ZONES),
    &            ZONE_NUM(MAX_ZONES),
    &            EXTRA_INFO_FLAG,
    &            NUMBER_SEGMENTS,
    &            NB_ZON_IN_SEGMENT(MAX_SEGMENTS),
    &            ZONES_IN_SEGMENT(MAX_SEGMENTS, MAX_ZONES),
    &            COVERAGE(MAX_SEGMENTS, MAX_ZONES),
    &            IERR(XV_NUM_ERR_MULTIZONES_VIS_TIME), STATUS

    REAL*8      ZONE_LONG(NUM_POINTS), ZONE_LAT(NUM_POINTS),
    &            ZONE_DIAM(NUM_DIAM), MIN_DURATION;

    CHARACTER*(*) ORBIT_SCENARIO_FILE, SWATH_FILE, ZONE_DB_FILE
    CHARACTER*9   ZONE_ID(MAX_ZONES)

```

```
#include"explorer_visibility.inc"
```

```

    STATUS = XV_MULTIZONES_VIS_TIME(
    &    SAT_ID, ORBIT_SCENARIO_FILE, ORBIT_TYPE,
    &    START_ORBIT, START_CYCLE,
    &    STOP_ORBIT, STOP_CYCLE,
    &    SWATH_FILE, NUM_ZONES,
    &    ZONE_ID, ZONE_DB_FILE,
    &    PROJECTION, ZONE_NUM,
    &    ZONE_LONG, ZONE_LAT, ZONE_DIAM, MIN_DURATION,
    &    EXTRA_INFO_FLAG,
    &    NUMBER_SEGMENTS,
    &    BGN_ORBIT, BGN_SECOND, BGN_MICROSEC, BGN_CYCLE,
    &    END_ORBIT, END_SECOND, END_MICROSEC, END_CYCLE,
    &    NB_ZON_IN_SEGMENT, ZONES_IN_SEGMENT, COVERAGE,
    &    IERR)

```

```
C TEST STATUS
```



### 7.6.3 Input parameters *xv\_multizones\_vis\_time*

Table 21: Input parameters of *xv\_multizones\_vis\_time*

c name	c type	Array Element	Description	Units	Range
orbit_id	xo_orbit_id*	-	Structure that contains the orbit data	-	-
orbit_type	long	-	Define the type of orbit representation, i.e. absolute or relative orbits in the input/output parameters	-	Complete (see table 2)
start_orbit	long	-	First orbit, segment filter. Segments will be filtered as from the beginning of first orbit (within orbit range from orbit_scenario_file) First Orbit in the orbit_scenario_file will be used when: <ul style="list-style-type: none"> <li>Absolute orbit is set to zero.</li> <li>Relative orbit and cycle number set to zero.</li> </ul>	absolute or relative orbit number	= 0 or: <ul style="list-style-type: none"> <li>absolute orbits <math>\geq</math> start_osf</li> <li>relative orbits <math>\leq</math> repeat cycle</li> </ul>
start_cycle	long	-	Cycle number corresponding to the start_orbit. Dummy when using relative orbits	cycle number	= 0 or $\geq$ first cycle in osf
stop_orbit	long	-	Last orbit, segment filter. When: <ul style="list-style-type: none"> <li>stop_orbit = 0 (for orbit_type = XV_ORBIT_ABS)</li> <li>stop_orbit = 0 and stop_cycle = 0 (for orbit_type = XV_ORBIT_REL)</li> </ul> the stop_orbit will be set to the minimum value between: <ul style="list-style-type: none"> <li>the last orbit within the orbital change of the start_orbit.</li> <li>start_orbit+cycle_length-1 (i.e. the input orbit range will be a complete cycle)</li> </ul>	absolute or relative orbit number	= 0 or: <ul style="list-style-type: none"> <li>absolute orbits <math>\geq</math> start_osf</li> <li>relative orbits <math>\leq</math> repeat cycle</li> </ul>
stop_cycle	long	-	Cycle number corresponding to the stop_orbit. Dummy when using relative orbits	cycle number	= 0 or $\geq$ first cycle in osf

**Table 21: Input parameters of xv\_multizones\_vis\_time**

c name	c type	Array Element	Description	Units	Range
swath_flag	long*	-	Define the use of the swath file: <ul style="list-style-type: none"> <li>• 0 = (XV_STF) if the swath file is a swath template file.</li> <li>• &gt; 0 if the swath files is a swath definition file. In this case the swath points are generated for every “swath_flag” orbits</li> </ul>	-	XV_STF = 0 XV_SDF = 1 > 0
swath_file	char *	-	File name of the swath-file for the appropriate instrument mode		
num_zones	long	-	Number of zones		>0
zone_id	char**	all	Identification name for n-th zone (0<n<num_zones). It must exist for every zone. zone_id[i] must belong to a zone from the zone_db_file when zone_num[i]=0.		EXACTLY 8 characters for each zone
zone_db_file	char *	-	File name of the zone-database file. Dummy when no zones from database are selected.		
projection	long*	all	projection for each zone used to define polygon sides as straight lines.		complete. See table 2 (Projections)
zone_num	long*	all	Number of vertices of the n-th zone (0<n<num_zones) provided in zone_long, zone_lat: = 0 no vertices provided, use zone_id / zone_db_file = 1 Point / Circular zone, = 2 Line zone > 2 Polygon zone		≥ 0
zone_long	double*	all	Geocentric longitude of - circle centre, for circ. zone - point, for point zone - line-end, for line zone - vertices, for polygon zone. The longitude of the vertices corresponding to all zones shall be arranged consecutively <sup>a</sup> .	deg	

**Table 21: Input parameters of xv\_multizones\_vis\_time**

c name	c type	Array Element	Description	Units	Range
zone_lat	double*	all	Geodetic latitude of - circle centre, for circ. zone. - point, for point zone. - line-end, for line zone. - vertices, for polygon zone. The latitude of the vertices corresponding to all zones shall be arranged consecutively <sup>a</sup> .	deg	
zone_diam	double*	all	Array of diameters of circular zones in case this shape is selected for any zone <sup>b</sup> . zone_diam=0.0 for Point Zones.	m	≥ 0.0
min_duration	double	-	Minimum duration for segments. Only segments with a duration longer than min_duration will be given on output.	s	≥ 0
extra_info_flag	long	-	If value set to false (= 0), the zones_in_segment and coverage arrays are not computed. Saves computation time.		0 (false), 1 (true)

a. For example,

- zone 0: points will be arranged from 0 to zone\_num[0] (no points in case of using a database zone),
- zone 1: points will be arranged from zone\_num[0] to zone\_num[0] + zone\_num[1]
- ...

b. The values corresponding to all zones shall be arranged consecutively, so that the zone\_diam[0] corresponds with the first point or circular zone, zone\_diam[1] corresponds with the second point or circular zone, and so on.

## 7.6.4 Output parameters *xv\_multizones\_vis\_time*

Table 22: Output parameters of *xv\_multizones\_vis\_time*

c name	c type	Array Element	Description	Unit	Range
<i>xv_multizones_vis_time</i>	long		Function status flag, = 0 No error > 0 Warnings, results generated < 0 Error, no results generated		
number_segments	long	-	Number of segments in the output lists.	-	> 0
bgn_orbit	long*	all	Array of orbit numbers for the beginning of the segments	-	>0
bgn_second	long*	all	Array of seconds elapsed since ANX for the beginning of the segments	-	>0 <nodal period
bgn_microsec	long*	all	Array of microseconds within a second for the beginning of the segments	-	>0 <999999
bgn_cycle	long*	all	Array of cycle numbers for the beginning of the segments.	-	>0
end_orbit	long*	all	Array of orbit numbers for the end of the segments	-	>0
end_second	long*	all	Array of seconds elapsed since ANX for the end of the segments	-	>0 <nodal period
end_microsec	long*	all	Array of microseconds within a second for the end of the segments	-	>0 <999999
end_cycle	long*	all	Array of cycle numbers for the end of the segments.	-	>0 or NULL
nb_zon_in_segment	long*	all	Number of zones where the segment has visibility. Dummy if extra_info_flag=0 (false).	-	>0
zones_in_segment	long**	all	Index of the zone_id input array where the segment has visibility. Dummy if extra_info_flag=0 (false).	-	≥0

**Table 22: Output parameters of xv\_multizones\_vis\_time**

c name	c type	Array Element	Description	Unit	Range
coverage	long**	all	Coverage of the segment in each of the zones. Dummy if extra_info_flag=0 (false).		complete See table 2
ierr	long*		Error status flags		

Note 1: The zones\_in\_segment and coverage arrays are returned as a two-dimensional table where the first index is related to the output visibility segment , and the second one goes all over the zones that compose that segment.

Note2 (Memory Management): Note that the output visibility segments arrays are pointers to integers instead of static arrays. The memory for these dynamic arrays is allocated within the **xv\_multizones\_vis\_time** function. So the user will only have to declare those pointers but not to allocate memory for them. However, once the function has returned without error, the user will have the responsibility of freeing the memory for those pointers once they are not used.

### 7.6.5 Warnings and errors

Next table lists the possible error messages that can be returned by the **xv\_multizones\_vis\_time** CFI function after translating the returned status vector into the equivalent list of error messages by calling the function of the EXPLORER\_VISIBILITY software library **xv\_get\_msg**.

This table also indicates the type of message returned, i.e. either a warning (WARN) or an error (ERR), the cause of such a message and the impact on the performed calculation, mainly on the results vector.

The table is completed by the error code and value. These error codes can be obtained translating the status vector returned by the **xv\_multizones\_vis\_time** CFI function by calling the function of the EXPLORER\_VISIBILITY software library **xv\_get\_code**.

Error type	Error message	Cause and impact	Error Code	Error No
ERR	Error allocating internal memory.	Computation not performed	XV_CFI_MULTIZONES_VIS_TIME_MEMORY_ERR	0
ERR	Error getting visibility segments for zone %ld	Computation not performed	XV_CFI_MULTIZONES_VIS_TIME_COMPUTE_SEGMENTS_ERR	1
ERR	Error getting absolute orbit from relative orbit	Computation not performed	XV_CFI_MULTIZONES_VIS_TIME_ABS_TO_REL_ORBIT_ERR	2
ERR	Error getting relative orbit vector from absolute orbits	Computation not performed	XV_CFI_MULTIZONES_VIS_TIME_ABS_TO_REL_VECTOR_ERR	3
ERR	Error while merging overlapped segments	Computation not performed	XV_CFI_MULTIZONES_VIS_TIME_OVERLAP_ERR	4

---

### 7.6.6 Runtime performances

The following runtime performance has been measured.

*Table 23: Runtime performances of xv\_multizones\_vis\_time function*

Ultra Sparc [ms]
TBD

## 7.7 xv\_multistations\_vis\_time

### 7.7.1 Overview

The **xv\_multistations\_vis\_time** function computes visibility segments of several ground stations, i.e. the orbital segments for which the satellite is visible from a ground station located at the surface of the Earth.

The visibility segments are obtained by calling to **xv\_station\_vis\_time**. Those segments are merged and ordered by start time. Moreover, **xv\_multistations\_vis\_time** provides a table containing the stations from which the satellite is visible in each segment.

In addition, **xv\_multistations\_vis\_time** computes the time of zero-doppler (i.e. the time at which the range-rate to the station is zero) per station.

The time intervals used by **xv\_multistations\_vis\_time** are expressed in absolute orbit numbers or in relative orbit and cycle numbers. This is valid for both:

- input parameter “Orbit Range”: first and last orbit to be considered. In case of using relative orbits, the corresponding cycle number should be used, otherwise, this the cycle number will be a dummy parameter.
- output parameter “Stations Visibility Segments”: time segments with time expressed as {absolute orbit number (or relative orbit number and cycle number), number of seconds since ascending node, number of microseconds}

The orbit representation (absolute or relative) for the output segments will be the same as in the input orbits.

**xv\_multistations\_vis\_time** requires access to several data structures and files to produce its results:

- the orbit\_id (xo\_orbit\_id) providing the orbital data. The orbit\_id can be initialized with the following data or files (see [ORBIT\_SUM]):
  - data for an orbital change
  - Orbit scenario files
  - Predicted orbit files
  - Orbit Event Files
  - Restituted orbit files
  - DORIS Preliminary orbit files
  - DORIS Navigator files
- the Instrument Swath File, excluding inertial swath files, describing the area seen by the relevant instrument all along the current orbit. The Swath data can be provided by:
  - A swath template file produced off-line by the EXPLORER\_VISIBILITY library (**xv\_gen\_swath** function).
  - A swath definition file, describing the swath geometry. In this case the **xv\_multistations\_vis\_time** generates the swath points for a number of orbits given by the user.
- the Instrument Swath File, excluding inertial swath files, describing the area seen by the relevant instrument all along the current orbit. It is produced off-line by the EXPLORER\_VISIBILITY library (**xv\_gen\_swath** function).
- the Station Database File, describing the location and the physical mask of each ground station.

Users who need to use processing times must make use of the conversion routines provided in EXPLORER\_ORBIT (**xo\_time\_to\_orbit** and **xo\_orbit\_to\_time** functions).



---

**NOTE:** Since the orbit swath template file is generated from a reference orbit, it is not recommended to use **xv\_multistation\_vis\_time** for a range of orbits that includes an orbital change (e.g. change in the repeat cycle or cycle length). If this would happen, **xv\_multistation\_vis\_time** automatically will ignore those orbits that do not correspond with the template file (i.e. no visibility segments will be generated for those orbits).

## 7.7.2 Calling sequence *xv\_multistations\_vis\_time*

For C programs, the call to **xv\_multistations\_vis\_time** is (input parameters are underlined):

```
#include "explorer_visibility.h"
{

    xo_orbit_id  orbit_id = {NULL};
    long        swath_flag, orbit_type,
               start_orbit, start_cycle,
               stop_orbit, stop_cycle,
               num_stations, *mask,
               extra_info_flag,
               number_segments,
               *bgn_orbit, *bgn_secs, *bgn_microsecs, *bgn_cycle,
               *end_orbit, *end_secs, *end_microsecs, *end_cycle,
               **zdop_orbit, **zdop_secs, **zdop_microsecs, **zdop_cycle,
               *nb_stat_in_segment, **stat_in_segment,
               ierr[XV_NUM_ERR_MULTISTATIONS_VIS_TIME], status;

    double      *aos_elevation, *los_elevation,
               min_duration;

    char        *swath_file, *station_db_file,
               **station_id;

    status = xv_multistations_vis_time(
        &orbit_id, &orbit_type,
        &start_orbit, &start_cycle,
        &stop_orbit, &stop_cycle,
        &swath_flag, swath_file, &num_stations,
        station_db_file, station_id,
        aos_elevation, los_elevation, mask,
        &min_duration,
        &extra_info_flag,
        &number_segments,
        &bgn_orbit, &bgn_second, &bgn_microsec, &bgn_cycle,
        &end_orbit, &end_second, &end_microsec, &end_cycle,
        &zdop_orbit, &zdop_second, &zdop_microsec, &zdop_cycle,
        &nb_stat_in_segment, &stat_in_segment,
        ierr);

    /* Or, using the run_id */
    long run_id;

    status = xv_multistations_vis_time_run(
        &run_id, &orbit_type,
        &start_orbit, &start_cycle,
```

```

    &stop_orbit, &stop_cycle,
    &swath_flag, swath_file, &num_stations,
    station_db_file, station_id,
    aos_elevation, los_elevation, mask,
    &min_duration,
    &extra_info_flag,
    &number_segments,
    &bgn_orbit, &bgn_second, &bgn_microsec, &bgn_cycle,
    &end_orbit, &end_second, &end_microsec, &end_cycle,
    &zdop_orbit, &zdop_second, &zdop_microsec, &zdop_cycle,
    &nb_stat_in_segment, &stat_in_segment,
    ierr);
}

```

For FORTRAN programs **xv\_multistations\_vis\_time** has the following calling sequence (input parameters are underlined, note that the C preprocessor must be used because of the presence of the #include statement):

```

    INTEGER*4    SAT_ID, ORBIT_TYPE,
    &            START_ORBIT, START_CYCLE,
    &            STOP_ORBIT, STOP_CYCLE,
    &            NUM_STATIONS, *MASK,
    &            EXTRA_INFO_FLAG,
    &            NUMBER_SEGMENTS,
    &            BGN_ORBIT(MAX_SEGMENTS), BGN_SECS(MAX_SEGMENTS)
    &            BGN_MICROSECS(MAX_SEGMENTS), BGN_CYCLE(MAX_SEGMENTS),
    &            END_ORBIT(MAX_SEGMENTS), END_SECS(MAX_SEGMENTS),
    &            END_MICROSECS(MAX_SEGMENTS), END_CYCLE(MAX_SEGMENTS),
    &            ZDOP_ORBIT(MAX_SEGMENTS,MAX_NUM_STATIONS),
    &            ZDOP_SECS(MAX_SEGMENTS,MAX_NUM_STATIONS),
    &            ZDOP_MICROSECS(MAX_SEGMENTS,MAX_NUM_STATIONS),
    &            ZDOP_CYCLE(MAX_SEGMENTS,MAX_NUM_STATIONS),
    &            NB_STAT_IN_SEGMENT(MAX_SEGMENTS),
    &            STAT_IN_SEGMENT(MAX_SEGMENTS,MAX_NUM_STATIONS),
    &            IERR(XV_NUM_ERR_MULTISTATIONS_VIS_TIME), STATUS

    REAL*8      AOS_ELEVATION(MAX_STATIONS),
    &            LOS_ELEVATION(MAX_STATIONS), MIN_DURATION

    CHARACTER*(*) ORBIT_SCENARIO_FILE, SWATH_FILE, STATION_DB_FILE
    CHARACTER*8   STATION_ID(MAX_STATIONS);

```

```
#include"explorer_visibility.inc"
```

```

STATUS = XV_MULTISTATIONS_VIS_TIME(
    SAT_ID, ORBIT_SCENARIO_FILE, ORBIT_TYPE,
    START_ORBIT, START_CYCLE,
    STOP_ORBIT, STOP_CYCLE,
    SWATH_FILE, NUM_STATIONS,

```

```
STATION_DB_FILE, STATION_ID,  
AOS_ELEVATION, LOS_ELEVATION, MASK,  
MIN_DURATION,  
EXTRA_INFO_FLAG,  
NUMBER_SEGMENTS,  
BGN_ORBIT, BGN_SECOND, BGN_MICROSEC, BGN_CYCLE,  
END_ORBIT, END_SECOND, END_MICROSEC, END_CYCLE,  
ZDOP_ORBIT, ZDOP_SECOND, ZDOP_MICROSEC, ZDOP_CYCLE,  
NB_STAT_IN_SEGMENT, STAT_IN_SEGMENT,  
IERR);
```

C TEST STATUS

### 7.7.3 Input parameters *xv\_multistations\_vis\_time*

Table 24: Input parameters of *xv\_multistations\_vis\_time*

c name	c type	Array Element	Description	Units	Range
orbit_id	xo_orbit_id*	-	Structure that contains the orbit data	-	-
orbit_type	long	-	Define the type of orbit representation, i.e. absolute or relative orbits in the input/output parameters	-	Complete (see table 2)
start_orbit	long	-	First orbit, segment filter Segments will be filtered as from the beginning of first orbit (within orbit range from orbit_scenario_file) First Orbit in the orbit_scenario_file will be used when: <ul style="list-style-type: none"> <li>Absolute orbit is set to zero.</li> <li>Relative orbit and cycle number set to zero.</li> </ul>	absolute or relative orbit number	= 0 or: <ul style="list-style-type: none"> <li>absolute orbits <math>\geq</math> start_osf</li> <li>relative orbits <math>\leq</math> repeat cycle</li> </ul>
start_cycle	long	-	Cycle number corresponding to the start_orbit. Dummy when using relative orbits	cycle number	= 0 or $\geq$ first cycle in osf
stop_orbit	long	-	Last orbit, segment filter. When: <ul style="list-style-type: none"> <li>stop_orbit = 0 (for orbit_type = XV_ORBIT_ABS)</li> <li>stop_orbit = 0 and stop_cycle = 0 (for orbit_type = XV_ORBIT_REL)</li> </ul> the stop_orbit will be set to the minimum value between: <ul style="list-style-type: none"> <li>the last orbit within the orbital change of the start_orbit.</li> <li>start_orbit+cycle_length-1 (i.e. the input orbit range will be a complete cycle)</li> </ul>	absolute or relative orbit number	= 0 or: <ul style="list-style-type: none"> <li>absolute orbits <math>\geq</math> start_osf</li> <li>relative orbits <math>\leq</math> repeat cycle</li> </ul>
stop_cycle	long	-	Cycle number corresponding to the stop_orbit. Dummy when using relative orbits	cycle number	= 0 or $\geq$ first cycle in osf

**Table 24: Input parameters of xv\_multistations\_vis\_time**

c name	c type	Array Element	Description	Units	Range
swath_flag	long*	-	Define the use of the swath file: <ul style="list-style-type: none"> <li>• 0 = (XV_STF) if the swath file is a swath template file.</li> <li>• &gt; 0 if the swath files is a swath definition file. In this case the swath points are generated for every “swath_flag” orbits</li> </ul>	-	XV_STF = 0 XV_SDF = 1 > 0
swath_file	char *	-	File name of the swath-file for the appropriate instrument mode		
num_stations	long	-	Number of stations		>0
station_db_file	char *	-	File name of the station-database file.		
station_id	char**	-	Identification name for n-th station (0<n<num_stations).		8 characters exactly
aos_elevation	double*	all	Minimum elevation to consider at AOS for each station(i.e. before considering start of visibility).	deg	≥ 0.0
los_elevation	double*	all	Maximum elevation to consider at LOS for each station(i.e. before considering end of visibility).	deg	≥ 0.0 ≤ aos_elevation
mask	long*	all	mask used to define visibility = 0 combine AOS/LOS elevations and physical mask (nominal mode) = 1 consider only AOS/LOS elevations = 2 consider only physical mask		≥ 0
min_duration	double	-	Minimum duration for segments. Only segments with a duration longer than min_duration will be given on output.	s	≥ 0
extra_info_flag	long	-	If value set to false (= 0), the zero doppler arrays and stations arrays are not computed. Saves computation time.		0(false), 1 (true)

### 7.7.4 Output parameters *xv\_multistations\_vis\_time*

**Table 25: Output parameters of *xv\_multistations\_vis\_time***

c name	c type	Array El.	Description	Unit	Range
<i>xv_multistations_vis_time</i>	long		Function status flag, = 0 No error > 0 Warnings, results generated < 0 Error, no results generated		
<i>number_segments</i>	long	-	Number of segments in the output lists.	-	> 0
<i>bgn_orbit</i>	long*	all	Array of orbit numbers for the beginning of the segments	-	>0
<i>bgn_second</i>	long*	all	Array of seconds elapsed since ANX for the beginning of the segments	-	>0 <nodal period
<i>bgn_microsec</i>	long*	all	Array of micro seconds within a second for the beginning of the segments	-	>0 <999999
<i>bgn_cycle</i>	long*	all	Array of cycle numbers for the beginning of the segments.	-	>0
<i>end_orbit</i>	long*	all	Array of orbit numbers for the end of the segments	-	>0
<i>end_second</i>	long*	all	Array of seconds elapsed since ANX for the end of the segments	-	>0 <nodal period
<i>end_microsec</i>	long*	all	Array of micro seconds within a second for the end of the segments	-	>0 <999999
<i>end_cycle</i>	long*	all	Array of cycle numbers for the end of the segments.	-	>0 or NULL
<i>zdop_orbit</i>	long**	all	Orbit number, time of zero doppler for each segment and zone (-1 if no zero doppler within corresponding visibility segment) Dummy if <i>extra_info_flag</i> = false.		> 0
<i>zdop_second</i>	long**	all	Seconds since ascending node, time of zero doppler for each segment and zone (-1 if no zero doppler within corresponding visibility segment) Dummy if <i>extra_info_flag</i> = false.	s	>= 0 < orbital period

**Table 25: Output parameters of xv\_multistations\_vis\_time**

c name	c type	Array El.	Description	Unit	Range
zdop_microsec	long**	all	Micro seconds within second time of zero doppler for each segment and zone (-1 if no zero doppler within corresponding visibility segment) Dummy if extra_info_flag = false.	μs	0 =< =< 999999
zdop_cycle	long**	all	Cycle number, time of zero doppler for each segment and zone (-1 if no zero doppler within corresponding visibility segment) Dummy if extra_info_flag = false.		>0 NULL when using absolute orbits
nb_stat_in_segment	long*	all	nb_stat_in_segment [i] =Number of stations from which the satellite is visible during the i-th segment of time. Dummy if extra_info_flag = false.	-	>0
stat_in_segment	long**	all	stat_in_segment [i] = array of indexes of the stations from which the satellite is visible during the i-th segment. Dummy if extra_info_flag = false.	-	≥0
ierr	long*		Error status flags		

**Note 1:** The stat\_in\_segment and zdop\_xxx arrays are returned as a two-dimensional table where the first index is related to the output visibility segment, and the second one goes all over the zones that compose that segment.

**Note 2 (Memory Management):** Note that the output visibility segments arrays are pointers to integers instead of static arrays. The memory for these dynamic arrays is allocated within the **xv\_multistations\_vis\_time** function. So the user will only have to declare those pointers but not to allocate memory for them. However, once the function has returned without error, the user will have the responsibility of freeing the memory for those pointers once they are not used.



### 7.7.5 Warnings and errors

Next table lists the possible error messages that can be returned by the **xv\_multistations\_vis\_time** CFI function after translating the returned status vector into the equivalent list of error messages by calling the function of the EXPLORER\_VISIBILITY software library **xv\_get\_msg**.

This table also indicates the type of message returned, i.e. either a warning (WARN) or an error (ERR), the cause of such a message and the impact on the performed calculation, mainly on the results vector.

The table is completed by the error code and value. These error codes can be obtained translating the status vector returned by the **xv\_multistations\_vis\_time** CFI function by calling the function of the EXPLORER\_VISIBILITY software library **xv\_get\_code**.

Error type	Error message	Cause and impact	Error Code	Error No
ERR	Error allocating internal memory.	Computation not performed	XV_CFI_MULTISTATIONS_VIS_TIME_MEMORY_ERR	0
ERR	Error getting visibility segments for station %ld	Computation not performed	XV_CFI_MULTISTATIONS_VIS_TIME_COMPUTE_SEGMENTS_ERR	1
ERR	Error getting absolute orbit from relative orbit	Computation not performed	XV_CFI_MULTISTATIONS_VIS_TIME_ABS_TO_REL_ORBIT_ERR	2
ERR	Error getting relative orbit vector from absolute orbits.	Computation not performed	XV_CFI_MULTISTATIONS_VIS_TIME_ABS_TO_REL_VECTOR_ERR	3
ERR	Error while merging overlapped segments.	Computation not performed	XV_CFI_MULTISTATIONS_VIS_TIME_OVERLAP_ERR	4

---

### ***7.7.6 Runtime performances***

The following runtime performance has been measured.

*Table 26: Runtime performances of xv\_multistations\_vis\_time function*

Ultra Sparc [ms]
TBD

---

## 7.8 xv\_orbit\_extra

### 7.8.1 Overview

The **xv\_orbit\_extra** function computes for an input orbit, the times for:

- an input set of Sun zenith angles are reached (both up and down times are computed)
- sun occultations by the Earth.
- sun occultations by the moon.

**xv\_orbit\_extra** needs as input the orbital parameters returned by **xo\_orbit\_info\_from\_xxx** (its output array **result\_vector**) where **xxx** stands for **abs**, **rel**, **phase**. So, the natural use to call to **xv\_orbit\_extra** will be:

- Initialise time references: calling to **xl\_time\_ref\_init** of **xl\_time\_ref\_init\_file**.
- Call to **xo\_orbit\_info\_from\_xxx** to get the **result\_vector** containing the orbital parameters of the orbit.
- Call to **xv\_orbit\_extra** with the same orbit than in the call to the **orbit\_info** function.

The input orbit must be an absolute orbit. Note that the absolute orbit will always be known as the call to **orbit\_info** provides this value together with the result vector.

Users who need to use processing times must make use of the conversion routines provided in EXPLORER\_ORBIT (**xo\_time\_to\_orbit** and **xo\_orbit\_to\_time** functions).

## 7.8.2 Calling sequence *xv\_orbit\_extra*

For C programs, the call to **xv\_orbit\_extra** is (input parameters are underlined):

```
#include "explorer_visibility.h"
{

    xo_orbit_id   orbit_id = {NULL};
    long         orbit,
               num_sza,
               ierr[XV_NUM_ERR_ORBIT_EXTRA];
    double       orbit_info_vector[XO_ORBIT_INFO_EXTRA_NUM_ELEMENTS], *sza,
               *sza_up, *sza_down,
               eclipse_entry, eclipse_exit,
               sun_moon_entry, sun_moon_exit;

    status= xv_orbit_extra (&orbit_id, &orbit, orbit_info_vector,
                          &num_sza, sza,
                          &sza_up, &sza_down,
                          &eclipse_entry, &eclipse_exit,
                          &sun_moon_entry, &sun_moon_exit,
                          ierr);

    /* Or, using the run_id */
    long run_id;

    status= xv_orbit_extra_run (&run_id, &orbit, orbit_info_vector,
                              &num_sza, sza,
                              &sza_up, &sza_down,
                              &eclipse_entry, &eclipse_exit,
                              &sun_moon_entry, &sun_moon_exit,
                              ierr);
}

```

For FORTRAN programs **xv\_orbit\_extra** has the following calling sequence (input parameters are underlined, note that the C preprocessor must be used because of the presence of the #include statement):

```
#include "explorer_visibility.inc"

    INTEGER SAT_ID, ORBIT,
    &       NUM_SZA,
    &       IERR(XV_NUM_ERR_ORBIT_EXTRA)

    REAL*8 ORBIT_INFO_VECTOR(25), SZA(MAX_SZA),
    &       SZA_UP(MAX_SZA), SZA_DOWN(MAX_SZA),
    &       ECLIPSE_ENTRY, ECLIPSE_EXIT,
    &       SUN_MOON_ENTRY, SUN_MOON_EXIT

```

```
STATUS= XV_ORBIT_EXTRA (SAT_ID, ORBIT, ORBIT_INFO_VECTOR,
                        NUM_SZA, SZA,
                        SZA_UP, SZA_DOWN,
                        ECLIPSE_ENTRY, ECLIPSE_EXIT,
                        SUN_MOON_ENTRY, SUN_MOON_EXIT,
                        IERR);
```

### 7.8.3 Input parameters xv\_orbit\_extra

Table 27: Input parameters of xv\_orbit\_extra

c name	c type	Array Element	Description	Units	Range
orbit_id	xo_orbit_id*	-	Structure that contains the orbit data	-	-
orbit	long	-	absolute orbit number		≥ start osf
orbit_info_vector [XO_ORBIT_IN FO_EXTRA_NUM_ELEMENTS]	double	[0]	repeat_cycle	days	>0
		[1]	cycle_length	orbits	>0
		[2]	MLST drift		s/day
		[3]	MLST	deg	> 0 <360
		[4]	phasing	deg	> 0 <360
		[5]	UTC time at ascending node	days (processing format)	
		[6-8]	position at ANX	m	
		[9-11]	velocity at ANX	m/s	
		[12-17]	mean keplerian elements at ANX		
		[18-23]	osculating keplerian elements at ANX		
		[24]	Nodal period	s	
num_sza	long	-	Number of Sun Zenit angles in the sza array	-	>0
sza	double*	all	list of Sun Zenit angles to compute	deg	≥ 0 ≤ 180

### 7.8.4 Output parameters *xv\_orbit\_extra*

Table 28: Output parameters of *xv\_orbi\_extra*

c name	c type	Array Element	Description	Unit	Range
<i>xv_orbit_extra</i>	long	-	Function status flag, = 0 No error > 0 Warnings, results generated < 0 Error, no results generated		
<i>sza_up</i>	double	all	Seconds since ANX of Sun Zenith Angles when SZA is increasing with time.	s	$\geq 0$ $\leq$ orb. period
<i>sza_down</i>	double	all	Seconds since ANX of Sun Zenith Angles when SZA is decreasing with time.	s	$\geq 0$ $\leq$ orb. period
<i>eclipse_entry</i>	double	-	Seconds since ANX of eclipse entry. Note that the value is provided within the input orbit, so that the <i>eclipse_exit</i> will be less than the <i>eclipse_entry</i> if the ANX is in eclipse.	s	$\geq 0$ $\leq$ orbital period -1 if there is not eclipse
<i>eclipse_exit</i>	double	-	Seconds since ANX of eclipse exit. Note that the value is provided within the input orbit, so that the <i>eclipse_exit</i> will be less than the <i>eclipse_entry</i> if the ANX is in eclipse.	s	$\geq 0$ $\leq$ orbital period -1 if there is not eclipse
<i>sun_moon_entry</i>	double	-	Seconds since ANX of Sun Occultation by Moon entry.	s	<-1 if no occultation is found $\geq 0$ $\leq$ orbital period
<i>sun_moon_exit</i>	double	-	Seconds since ANX of Sun Occultation by Moon exit	s	<-1 if no occultation is found $\geq 0$ $\leq$ orbital period
<i>ierr</i>	long*		Error status flags		

Note (Memory Management): Note that the *sza\_up* and *sza\_down* arrays are pointers instead of static arrays. The memory for these dynamic arrays is allocated within the ***xv\_orbit\_extra*** function. So the user will only have to declare those pointers but not to allocate memory for them. However, once the function has returned without error, the user will have the responsibility of freeing the memory for those pointers once they are not used.

### 7.8.5 Warnings and errors

Next table lists the possible error messages that can be returned by the **xv\_orbit\_extra** CFI function after translating the returned status vector into the equivalent list of error messages by calling the function of the EXPLORER\_VISIBILITY software library **xv\_get\_msg**.

This table also indicates the type of message returned, i.e. either a warning (WARN) or an error (ERR), the cause of such a message and the impact on the performed calculation, mainly on the results vector.

The table is completed by the error code and value. These error codes can be obtained translating the status vector returned by the **xv\_orbit\_extra** CFI function by calling the function of the EXPLORER\_VISIBILITY software library **xv\_get\_code**.

Error type	Error message	Cause and impact	Error Code	Error No
ERR	Wrong input orbit Id.	Computation not performed	XV_CFI_ORBIT_EXTRA_ORBIT_STATUS_ERROR	0
ERR	Error allocating memory for SZA entry/exit times	Computation not performed	XV_CFI_ORBIT_EXTRA_MEM_ERR	1
ERR	Error computing SZA entry/exit times	Computation not performed	XV_CFI_ECLIPSE_XL_EF_TO_QEF_ERR	2
ERR	Error computing eclipse entry/exit times	Computation not performed	XV_CFI_ORBIT_EXTRA_ECLIPSE_ERR	3
ERR	Error computing Sun occultation by Moon.	Computation not performed	XV_CFI_ORBIT_EXTRA_SUN_OCC_BY_MOON_ERR	4

### 7.8.6 Runtime performances

The following runtime performance has been measured.

*Table 29: Runtime performances of xv\_orbit\_extra function*

Ultra Sparc [ms]
TBD



## 7.9 xv\_gps\_vis\_time

TBW



## 7.10 xv\_time\_segments\_not

### 7.10.1 Overview

An orbital segment is a time interval along the orbit, defined by start and stop times expressed as an orbit number and the seconds elapsed since the ascending node crossing.

The **xv\_time\_segments\_not** function computes the compliment of a list of orbital segments (see Figure 13)

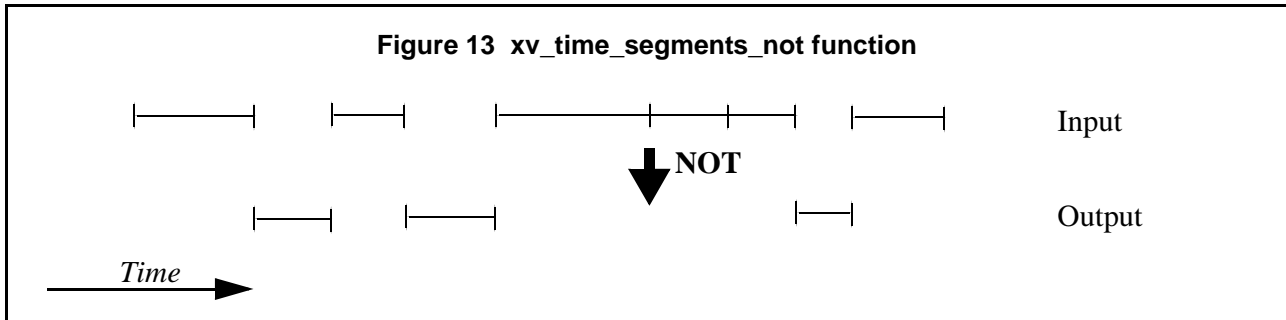

Note that the intervals from the first orbit to the first segment and from the last segment to the end of mission are not returned.

The input segments list need to be sorted according to the start time of the segments. If this list is not sorted, it should be indicated in the function interface with the corresponding parameter (see below). In this case the input list will be modified accordingly.

The time intervals used by **xv\_time\_segments\_not** can be expressed in absolute or relative orbit numbers. This is valid for both:

- input parameter: first and last orbit to be considered. In case of using relative orbits, the corresponding cycle numbers should be used, otherwise, the cycle number will be a dummy parameter.
- output parameter: time segments with time expressed as {absolute orbit number (or relative orbit and cycle number), number of seconds since ANX, number of micro seconds}

The orbit representation (absolute or relative) for the output segments will be the same as in the input orbits. Moreover, the segments will be ordered chronologically.

The **xv\_time\_segments\_not** requires access to the following files to produce its results:

- the Orbit Scenario File: only if the orbits are expressed in relative numbers.

## 7.10.2 Calling sequence *xv\_time\_segments\_not*

For C programs, the call to **xv\_time\_segments\_not** is (input parameters are underlined):

```
#include "explorer_visibility.h"
{

    xo_orbit_id  orbit_id = {NULL};
    long         orbit_type, order_switch,
                num_segments_in,
                *bgn_orbit_in, *bgn_secs_in,
                *bgn_microsecs_in, *bgn_cycle_in,
                *end_orbit_in, *end_secs_in,
                *end_microsecs_in, *end_cycle_in,
                num_segments_out,
                *bgn_orbit_out, *bgn_secs_out,
                *bgn_microsecs_out, *bgn_cycle_out,
                *end_orbit_out, *end_secs_out,
                *end_microsecs_out, *end_cycle_out,
                ierr[XV_NUM_ERR_NOT], status;

    status = xv_time_segments_not(
                &orbit_id,
                &orbit_type, &order_switch,
                &number_segments_in,
                bgn_orbit_in, bgn_secs_in,
                bgn_microsecs_in, bgn_cycle_in,
                end_orbit_in, end_secs_in,
                end_microsecs_in, end_cycle_in,
                &num_segments_out,
                &bgn_orbit_out, &bgn_secs_out,
                &bgn_microsecs_out, &bgn_cycle_out,
                &end_orbit_out, &end_secs_out,
                &end_microsecs_out, &end_cycle_out,
                ierr);

    /* Or, using the run_id */
    long run_id;

    status = xv_time_segments_not_run(
                &run_id,
                &orbit_type, &order_switch,
                &number_segments_in,
                bgn_orbit_in, bgn_secs_in,
                bgn_microsecs_in, bgn_cycle_in,
                end_orbit_in, end_secs_in,
                end_microsecs_in, end_cycle_in,
```

```

        &num_segments_out,
        &bgn_orbit_out, &bgn_secs_out,
        &bgn_microsecs_out, &bgn_cycle_out,
        &end_orbit_out, &end_secs_out,
        &end_microsecs_out, &end_cycle_out,
        ierr);
}

```

For FORTRAN programs **xv\_time\_segments\_not** has the following calling sequence (input parameters are underlined, note that the C preprocessor must be used because of the presence of the #include statement):

```

    INTEGER*4    SAT_ID, ORBIT_TYPE, ORDER_SWITCH,
&              NUM_SEGMENTS_IN,
&              BGN_ORBIT_IN, BGN_SECS_IN,
&              BGN_MICROSECS_IN, BGN_CYCLE_IN,
&              END_ORBIT_IN, END_SECS_IN,
&              END_MICROSECS_IN, END_CYCLE_IN,
&              NUM_SEGMENTS_OUT,
&              BGN_ORBIT_OUT, BGN_SECS_OUT,
&              BGN_MICROSECS_OUT, BGN_CYCLE_OUT,
&              END_ORBIT_OUT, END_SECS_OUT,
&              END_MICROSECS_OUT, END_CYCLE_OUT,
&              IERR(XV_NUM_ERR_NOT), STATUS;
    CHARACTER*(*)*ORBIT_SCENARIO_FILE

```

```
#include"explorer_visibility.inc"
```

```

STATUS = XV_TIME_SEGMENTS_NOT(
    SAT_ID, ORBIT_SCENARIO_FILE,
    ORBIT_TYPE, ORDER_SWITCH,
    NUMBER_SEGMENTS_IN,
    BGN_ORBIT_IN, BGN_SECS_IN,
    BGN_MICROSECS_IN, BGN_CYCLE_IN,
    END_ORBIT_IN, END_SECS_IN,
    END_MICROSECS_IN, END_CYCLE_IN,
    NUM_SEGMENTS_OUT,
    BGN_ORBIT_OUT, BGN_SECS_OUT,
    BGN_MICROSECS_OUT, BGN_CYCLE_OUT,
    END_ORBIT_OUT, END_SECS_OUT,
    END_MICROSECS_OUT, END_CYCLE_OUT,
    IERR)

```

C test status

### 7.10.3 Input parameters *xv\_time\_segments\_not*

**Table 30: Input parameters of *xv\_time\_segments\_not***

c name	c type	Array Element	Description	Units	Range
orbit_id	xo_orbit_id*	-	Structure that contains the orbit data	-	-
orbit_type	long	-	Define the type of orbit representation, i.e. absolute or relative orbits in the input/output parameters	-	Complete (see table 2)
order_switch	long	-	Indicates if the input list is sorted by start times. If input segments are already sorted, the flag should be set to <code>XV_TIME_ORDER</code> to save computation time.	-	Complete (see table 2)
num_segments_in	long	-	Number of segments in the input list.	-	>0
bgn_orbit_in	long*	all	Array of orbit numbers for the beginning of the segments	-	>0
bgn_secs_in	long*	all	Array of seconds elapsed since ANX for the beginning of the segments	-	>0 <nodal period
bgn_microsecs_in	long*	all	Array of microseconds within a second for the beginning of the segments	-	>0 <999999
bgn_cycle_in	long*	all	Array of cycle numbers for the beginning of the segments. When using absolute orbits, a NULL pointer can be used.	-	>0 or NULL
end_orbit_in	long*	all	Array of orbit numbers for the end of the segments	-	>0
end_secs_in	long*	all	Array of seconds elapsed since ANX for the end of the segments	-	>0 <nodal period
end_microsecs_in	long*	all	Array of seconds within a second for the end of the segments	-	>0 <999999
end_cycle_in	long*	all	Array of cycle numbers for the end of the segments. When using absolute orbits, a NULL pointer can be used.	-	>0 or NULL

### 7.10.4 Output parameters *xv\_time\_segments\_not*

**Table 31: Output parameters of *xv\_time\_segments\_not***

c name	c type	Array Element	Description	Unit	Range
<i>xv_time_segments_not</i>	long		Function status flag, = 0 No error > 0 Warnings, results generated < 0 Error, no results generated		
<i>num_segments_out</i>	long	-	Number of segments in the output list.	-	>0
<i>bgn_orbit_out</i>	long*	all	Array of orbit numbers for the beginning of the segments	-	>0
<i>bgn_secs_out</i>	long*	all	Array of seconds elapsed since ANX for the beginning of the segments	-	>0 <nodal period
<i>bgn_microsecs_out</i>	long*	all	Array of microseconds within a second for the beginning of the segments	-	>0 < 999999
<i>bgn_cycle_out</i>	long*	all	Array of cycle numbers for the beginning of the segments.	-	>0
<i>end_orbit_out</i>	long*	all	Array of orbit numbers for the end of the segments	-	>0
<i>end_secs_out</i>	long*	all	Array of seconds elapsed since ANX for the end of the segments	-	>0 <nodal period
<i>end_microsecs_out</i>	long*	all	Array of microseconds within a second for the end of the segments	-	>0 < 999999
<i>end_cycle_out</i>	long*	all	Array of cycle numbers for the end of the segments.	-	>0 or NULL
<i>ierr[10]</i>	long		Error status flags		

**Memory Management:** Note that the output visibility segments arrays are pointers to integers instead of static arrays. The memory for these dynamic arrays is allocated within the ***xv\_time\_segments\_not*** function. So the user will only have to declare those pointers but not to allocate memory for them. However, once the function has returned without error, the user will have the responsibility of freeing the memory for those pointers once they are not used.

### 7.10.5 Warnings and errors

Next table lists the possible error messages that can be returned by the **xv\_time\_segments\_not** CFI function after translating the returned status vector into the equivalent list of error messages by calling the function of the EXPLORER\_VISIBILITY software library **xv\_get\_msg**.

This table also indicates the type of message returned, i.e. either a warning (WARN) or an error (ERR), the cause of such a message and the impact on the performed calculation, mainly on the results vector.

The table is completed by the error code and value. These error codes can be obtained translating the status vector returned by the **xv\_time\_segments\_not** CFI function by calling the function of the EXPLORER\_VISIBILITY software library **xv\_get\_code**.

Error type	Error message	Cause and impact	Error Code	Error No
ERR	Error allocating internal memory.	Computation not performed	XV_CFI_TIME_SEGMENTS_NOT_MEMORY_ERR	0
ERR	Error getting absolute orbit vector from relative orbits.	Computation not performed	XV_CFI_TIME_SEGMENTS_NOT_REL_TO_ABS_ORBIT_ERR	1
ERR	Error getting relative orbit vector from absolute orbits.	Computation not performed	XV_CFI_TIME_SEGMENTS_NOT_ABS_TO_REL_ORBIT_ERR	2
ERR	Error sorting input list.	Computation not performed	XV_CFI_TIME_SEGMENTS_NOT_SORTING_ERR	3

---

### ***7.10.6 Runtime performances***

The following runtime performance has been measured.

*Table 32: Runtime performances of xv\_time\_segments\_not function*

Ultra Sparc [ms]
TBD

## 7.11 xv\_time\_segments\_or

### 7.11.1 Overview

An orbital segment is a time interval along the orbit, defined by start and stop times expressed as an orbit number and the seconds elapsed since the ascending node crossing.

The **xv\_time\_segments\_or** function computes the union of a list of orbital segments (see Figure 14)

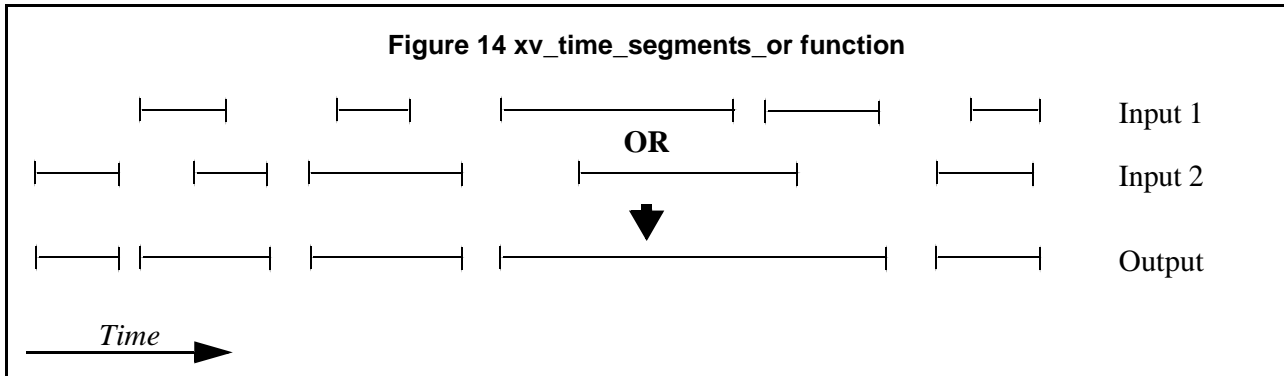

The input segments list need to be sorted according to the start time of the segments. If this list is not sorted, it should be indicated in the function interface with the corresponding parameter (see below). In this case the input list will be modified accordingly.

The time intervals used by **xv\_time\_segments\_or** can be expressed in absolute or relative orbit numbers. This is valid for both:

- input parameter: first and last orbit to be considered. In case of using relative orbits, the corresponding cycle numbers should be used, otherwise, the cycle number will be a dummy parameter.
- output parameter: time segments with time expressed as {absolute orbit number (or relative orbit and cycle number), number of seconds since ANX, number of microseconds}

The orbit representation (absolute or relative) for the output segments will be the same as in the input orbits. Moreover, the segments will be ordered chronologically.

The **xv\_time\_segments\_or** requires access to the following files to produce its results:

- the Orbit Scenario File: only if the orbits are expressed in relative numbers.



## 7.11.2 Calling sequence *xv\_time\_segments\_or*

For C programs, the call to **xv\_time\_segments\_or** is (input parameters are underlined):

```
#include "explorer_visibility.h"
{

    xo_orbit_id  orbit_id = {NULL};
    long         orbit_type, order_switch,
                num_segments_1,
                *bgn_orbit_1, *bgn_secs_1,
                *bgn_microsecs_1, *bgn_cycle_1,
                *end_orbit_1, *end_secs_1,
                *end_microsecs_1, *end_cycle_1,
                num_segments_2,
                *bgn_orbit_2, *bgn_secs_2,
                *bgn_microsecs_2, *bgn_cycle_2,
                *end_orbit_2, *end_secs_2,
                *end_microsecs_2, *end_cycle_2,
                num_segments_out,
                *bgn_orbit_out, *bgn_secs_out,
                *bgn_microsecs_out, *bgn_cycle_out,
                *end_orbit_out, *end_secs_out,
                *end_microsecs_out, *end_cycle_out,
                ierr[XV_NUM_ERR_OR], status;

    status = xv_time_segments_or (
        &orbit_id,
        &orbit_type, &order_switch,
        &number_segments_1,
        bgn_orbit_1, bgn_second_1,
        bgn_microsec_1, bgn_cycle_1,
        end_orbit_1, end_second_1,
        end_microsec_1, end_cycle_1,
        &number_segments_2,
        bgn_orbit_2, bgn_second_2,
        bgn_microsec_2, bgn_cycle_2,
        end_orbit_2, end_second_2,
        end_microsec_2, end_cycle_2,
        &num_segments_out,
        &bgn_orbit_out, &bgn_secs_out,
        &bgn_microsecs_out, &bgn_cycle_out,
        &end_orbit_out, &end_secs_out,
        &end_microsecs_out, &end_cycle_out,
        ierr);
}
```

```

/* Or, using the run_id */
long run_id;

status = xv_time_segments_or_run (
    &run_id,
    &orbit_type, &order_switch,
    &number_segments_1,
    bgn_orbit_1, bgn_second_1,
    bgn_microsec_1, bgn_cycle_1,
    end_orbit_1, end_second_1,
    end_microsec_1, end_cycle_1,
    &number_segments_2,
    bgn_orbit_2, bgn_second_2,
    bgn_microsec_2, bgn_cycle_2,
    end_orbit_2, end_second_2,
    end_microsec_2, end_cycle_2,
    &num_segments_out,
    &bgn_orbit_out, &bgn_secs_out,
    &bgn_microsecs_out, &bgn_cycle_out,
    &end_orbit_out, &end_secs_out,
    &end_microsecs_out, &end_cycle_out,
    ierr);
}

```

For FORTRAN programs **xv\_time\_segments\_or** has the following calling sequence (input parameters are underlined, note that the C preprocessor must be used because of the presence of the #include statement):

```

INTEGER*4    SAT_ID, ORBIT_TYPE, ORDER_SWITCH,
&           NUM_SEGMENTS_1,
&           BGN_ORBIT_1, BGN_SECS_1,
&           BGN_MICROSECS_1, BGN_CYCLE_1,
&           END_ORBIT_1, END_SECS_1,
&           END_MICROSECS_1, END_CYCLE_1,
&           NUM_SEGMENTS_2,
&           BGN_ORBIT_2, BGN_SECS_2,
&           BGN_MICROSECS_2, BGN_CYCLE_2,
&           END_ORBIT_2, END_SECS_2,
&           END_MICROSECS_2, END_CYCLE_2,
&           NUM_SEGMENTS_OUT,
&           BGN_ORBIT_OUT, BGN_SECS_OUT,
&           BGN_MICROSECS_OUT, BGN_CYCLE_OUT,
&           END_ORBIT_OUT, END_SECS_OUT,
&           END_MICROSECS_OUT, END_CYCLE_OUT,
&           IERR(XV_NUM_ERR_NOT), STATUS
CHARACTER*(*)ORBIT_SCENARIO_FILE

```

```
#include"explorer_visibility.inc"
```

---

```
STATUS = XV_TIME_SEGMENTS_OR(  
&          SAT_ID, ORBIT_SCENARIO_FILE,  
&          ORBIT_TYPE, ORDER_SWITCH,  
&          NUMBER_SEGMENTS_1,  
&          BGN_ORBIT_1, BGN_SECS_1,  
&          BGN_MICROSECS_1, BGN_CYCLE_1,  
&          END_ORBIT_1, END_SECS_1,  
&          END_MICROSECS_1, END_CYCLE_1,  
&          NUMBER_SEGMENTS_2,  
&          BGN_ORBIT_2, BGN_SECS_2,  
&          BGN_MICROSECS_2, BGN_CYCLE_2,  
&          END_ORBIT_2, END_SECS_2,  
&          END_MICROSECS_2, END_CYCLE_2,  
&          NUM_SEGMENTS_OUT,  
&          BGN_ORBIT_OUT, BGN_SECS_OUT,  
&          BGN_MICROSECS_OUT, BGN_CYCLE_OUT,  
&          END_ORBIT_OUT, END_SECS_OUT,  
&          END_MICROSECS_OUT, END_CYCLE_OUT,  
&          IERR)
```

C test status

### 7.11.3 Input parameters *xv\_time\_segments\_or*

**Table 33: Input parameters of *xv\_time\_segments\_or***

c name	c type	Array Element	Description	Units	Range
orbit_id	xo_orbit_id*	-	Structure that contains the orbit data	-	-
orbit_type	long	-	Define the type of orbit representation, i.e. absolute or relative orbits in the input/output parameters	-	Complete (see table 2)
order_switch	long	-	Indicates if the input list is sorted by start times. If input segments are already sorted, the flag should be set to <i>XV_TIME_ORDER</i> to save computation time.	-	Complete (see table 2)
num_segments_1	long	-	Number of segments in the input list 1.	-	>0
bgn_orbit_1	long*	all	Array of orbit numbers for the beginning of the segments in list 1	-	>0
bgn_secs_1	long*	all	Array of seconds elapsed since ANX for the beginning of the segments in list 1	-	>0 <nodal period
bgn_microsecs_1	long*	all	Array of microseconds within a second for the beginning of the segments in list 1	-	>0 <999999
bgn_cycle_1	long*	all	Array of cycle numbers for the beginning of the segments in list 1. When using absolute orbits, a NULL pointer can be used.	-	>0 or NULL
end_orbit_1	long*	all	Array of orbit numbers for the end of the segments in list 1	-	>0
end_secs_1	long*	all	Array of seconds elapsed since ANX for the end of the segments in list 1	-	>0 <nodal period
end_microsecs_1	long*	all	Array of microseconds within a second for the end of the segments in list 1	-	>0 <999999

**Table 33: Input parameters of xv\_time\_segments\_or**

c name	c type	Array Element	Description	Units	Range
end_cycle_1	long*	all	Array of cycle numbers for the end of the segments in list 1. When using absolute orbits, a NULL pointer can be used.	-	>0 or NULL
num_segments_2	long	-	Number of segments in the input list 2.	-	>0
bgn_orbit_2	long*	all	Array of orbit numbers for the beginning of the segments in list 2	-	>0
bgn_secs_2	long*	all	Array of seconds elapsed since ANX for the beginning of the segments in list 2	-	>0 <nodal period
bgn_microsecs_2	long*	all	Array of microseconds within a second for the beginning of the segments in list 2	-	>0 <999999
bgn_cycle_2	long*	all	Array of cycle numbers for the beginning of the segments in list 2. When using absolute orbits, a NULL pointer can be used.	-	>0 or NULL
end_orbit_2	long*	all	Array of orbit numbers for the end of the segments in list 2	-	>0
end_secs_2	long*	all	Array of seconds elapsed since ANX for the end of the segments in list 2	-	>0 <nodal period
end_microsecs_2	long*	all	Array of microseconds within a second for the end of the segments in list 2	-	>0 <999999
end_cycle_2	long*	all	Array of cycle numbers for the end of the segments in list 2. When using absolute orbits, a NULL pointer can be used.	-	>0 or NULL

### 7.11.4 Output parameters *xv\_time\_segments\_or*

**Table 34: Output parameters of *xv\_time\_segments\_or***

c name	c type	Array Element	Description	Unit	Range
<i>xv_time_segments_or</i>	long		Function status flag, = 0 No error > 0 Warnings, results generated < 0 Error, no results generated		
<i>num_segments_out</i>	long	-	Number of segments in the output list.	-	>0
<i>bgn_orbit_out</i>	long*	all	Array of orbit numbers for the beginning of the segments	-	>0
<i>bgn_secs_out</i>	long*	all	Array of seconds elapsed since ANX for the beginning of the segments	-	>0 <nodal period
<i>bgn_microsecs_out</i>	long*	all	Array of microseconds within a second for the beginning of the segments	-	>0 <999999
<i>bgn_cycle_out</i>	long*	all	Array of cycle numbers for the beginning of the segments.	-	>0
<i>end_orbit_out</i>	long*	all	Array of orbit numbers for the end of the segments	-	>0
<i>end_secs_out</i>	long*	all	Array of seconds elapsed since ANX for the end of the segments	-	>0 <nodal period
<i>end_microsecs_out</i>	long*	all	Array of microseconds within a second for the end of the segments	-	>0 <999999
<i>end_cycle_out</i>	long*	all	Array of cycle numbers for the end of the segments.	-	>0 or NULL
<i>ierr[10]</i>	long		Error status flags		

**Memory Management:** Note that the output visibility segments arrays are pointers to integers instead of static arrays. The memory for these dynamic arrays is allocated within the ***xv\_time\_segments\_or*** function. So the user will only have to declare those pointers but not to allocate memory for them. However, once the function has returned without error, the user will have the responsibility of freeing the memory for those pointers once they are not used.

### 7.11.5 Warnings and errors

Next table lists the possible error messages that can be returned by the **xv\_time\_segments\_or** CFI function after translating the returned status vector into the equivalent list of error messages by calling the function of the EXPLORER\_VISIBILITY software library **xv\_get\_msg**.

This table also indicates the type of message returned, i.e. either a warning (WARN) or an error (ERR), the cause of such a message and the impact on the performed calculation, mainly on the results vector.

The table is completed by the error code and value. These error codes can be obtained translating the status vector returned by the **xv\_time\_segments\_or** CFI function by calling the function of the EXPLORER\_VISIBILITY software library **xv\_get\_code**.

Error type	Error message	Cause and impact	Error Code	Error No
ERR	Error allocating internal memory.	Computation not performed	XV_CFI_TIME_SEGMENTS_OR_MEMORY_ERR	0
ERR	Error getting absolute orbit vector from relative orbits.	Computation not performed	XV_CFI_TIME_SEGMENTS_OR_REL_TO_ABS_ORBIT_ERR	1
ERR	Error getting relative orbit vector from absolute orbits.	Computation not performed	XV_CFI_TIME_SEGMENTS_OR_ABS_TO_REL_ORBIT_ERR	2
ERR	Error sorting input list.	Computation not performed	XV_CFI_TIME_SEGMENTS_OR_SORTING_ERR	3

---

### ***7.11.6 Runtime performances***

The following runtime performance has been measured.

*Table 35: Runtime performances of xv\_time\_segments\_or function*

Ultra Sparc [ms]
TBD



## 7.12 xv\_time\_segments\_and

### 7.12.1 Overview

An orbital segment is a time interval along the orbit, defined by start and stop times expressed as an orbit number and the seconds elapsed since the ascending node crossing.

The **xv\_time\_segments\_and** function computes the intersection of a list of orbital segments (see Figure 15)

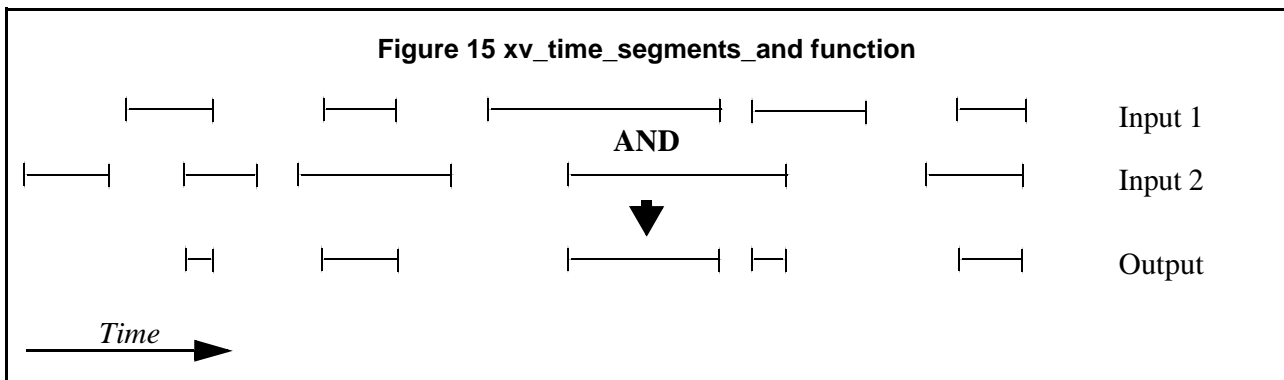

The input segments list need to be sorted according to the start time of the segments. If this list is not sorted, it should be indicated in the function interface with the corresponding parameter (see below). In this case the input list will be modified accordingly.

The time intervals used by **xv\_time\_segments\_and** can be expressed in absolute or relative orbit numbers. This is valid for both:

- input parameter: first and last orbit to be considered. In case of using relative orbits, the corresponding cycle numbers should be used, otherwise, the cycle number will be a dummy parameter.
- output parameter: time segments with time expressed as {absolute orbit number (or relative orbit and cycle number), number of seconds since ANX, number of microseconds}

The orbit representation (absolute or relative) for the output segments will be the same as in the input orbits. Moreover, the segments will be ordered chronologically.

The **xv\_time\_segments\_and** requires access to the following files to produce its results:

- the Orbit Scenario File: only if the orbits are expressed in relative numbers.

## 7.12.2 Calling sequence *xv\_time\_segments\_and*

For C programs, the call to **xv\_time\_segments\_and** is (input parameters are underlined):

```
#include "explorer_visibility.h"
{

    xo_orbit_id  orbit_id = {NULL};
    long        orbit_type, order_switch,
               num_segments_1,
               *bgn_orbit_1, *bgn_secs_1,
               *bgn_microsecs_1, *bgn_cycle_1,
               *end_orbit_1, *end_secs_1,
               *end_microsecs_1, *end_cycle_1,
               num_segments_2,
               *bgn_orbit_2, *bgn_secs_2,
               *bgn_microsecs_2, *bgn_cycle_2,
               *end_orbit_2, *end_secs_2,
               *end_microsecs_2, *end_cycle_2,
               num_segments_out,
               *bgn_orbit_out, *bgn_secs_out,
               *bgn_microsecs_out, *bgn_cycle_out,
               *end_orbit_out, *end_secs_out,
               *end_microsecs_out, *end_cycle_out,
               ierr[XV_NUM_ERR_AND], status;

    status = xv_time_segments_and (
        &orbit_id,
        &orbit_type, &order_switch,
        &number_segments_1,
        bgn_orbit_1, bgn_second_1,
        bgn_microsec_1, bgn_cycle_1,
        end_orbit_1, end_second_1,
        end_microsec_1, end_cycle_1,
        &number_segments_2,
        bgn_orbit_2, bgn_second_2,
        bgn_microsec_2, bgn_cycle_2,
        end_orbit_2, end_second_2,
        end_microsec_2, end_cycle_2,
        &num_segments_out,
        &bgn_orbit_out, &bgn_secs_out,
        &bgn_microsecs_out, &bgn_cycle_out,
        &end_orbit_out, &end_secs_out,
        &end_microsecs_out, &end_cycle_out,
        ierr);
}
```

---

```
/* Or, using the run_id */  
long run_id;  
  
status = xv_time_segments_and_run (  
    &run_id,  
    &orbit_type, &order_switch,  
    &number_segments_1,  
    bgn_orbit_1, bgn_second_1,  
    bgn_microsec_1, bgn_cycle_1,  
    end_orbit_1, end_second_1,  
    end_microsec_1, end_cycle_1,  
    &number_segments_2,  
    bgn_orbit_2, bgn_second_2,  
    bgn_microsec_2, bgn_cycle_2,  
    end_orbit_2, end_second_2,  
    end_microsec_2, end_cycle_2,  
    &num_segments_out,  
    &bgn_orbit_out, &bgn_secs_out,  
    &bgn_microsecs_out, &bgn_cycle_out,  
    &end_orbit_out, &end_secs_out,  
    &end_microsecs_out, &end_cycle_out,  
    ierr);  
  
}
```

For FORTRAN programs **xv\_time\_segments** and has the following calling sequence (input parameters are underlined, note that the C preprocessor must be used because of the presence of the #include statement):

```

    INTEGER*4    SAT_ID, ORBIT_TYPE, ORDER_SWITCH,
&              NUM_SEGMENTS_1,
&              BGN_ORBIT_1, BGN_SECS_1,
&              BGN_MICROSECS_1, BGN_CYCLE_1,
&              END_ORBIT_1, END_SECS_1,
&              END_MICROSECS_1, END_CYCLE_1,
&              NUM_SEGMENTS_2,
&              BGN_ORBIT_2, BGN_SECS_2,
&              BGN_MICROSECS_2, BGN_CYCLE_2,
&              END_ORBIT_2, END_SECS_2,
&              END_MICROSECS_2, END_CYCLE_2,
&              NUM_SEGMENTS_OUT,
&              BGN_ORBIT_OUT, BGN_SECS_OUT,
&              BGN_MICROSECS_OUT, BGN_CYCLE_OUT,
&              END_ORBIT_OUT, END_SECS_OUT,
&              END_MICROSECS_OUT, END_CYCLE_OUT,
&              IERR(XV_NUM_ERR_AND), STATUS
    CHARACTER*(*)ORBIT_SCENARIO_FILE
  
```

```
#include"explorer_visibility.inc"
```

```

    STATUS = XV_TIME_SEGMENTS_AND(
&          SAT_ID, ORBIT_SCENARIO_FILE,
&          ORBIT_TYPE, ORDER_SWITCH,
&          NUMBER_SEGMENTS_1,
&          BGN_ORBIT_1, BGN_SECS_1,
&          BGN_MICROSECS_1, BGN_CYCLE_1,
&          END_ORBIT_1, END_SECS_1,
&          END_MICROSECS_1, END_CYCLE_1,
&          NUMBER_SEGMENTS_2,
&          BGN_ORBIT_2, BGN_SECS_2,
&          BGN_MICROSECS_2, BGN_CYCLE_2,
&          END_ORBIT_2, END_SECS_2,
&          END_MICROSECS_2, END_CYCLE_2,
&          NUM_SEGMENTS_OUT,
&          BGN_ORBIT_OUT, BGN_SECS_OUT,
&          BGN_MICROSECS_OUT, BGN_CYCLE_OUT,
&          END_ORBIT_OUT, END_SECS_OUT,
&          END_MICROSECS_OUT, END_CYCLE_OUT,
&          IERR)
  
```

C test status

### 7.12.3 Input parameters xv\_time\_segments\_and

**Table 36: Input parameters of xv\_time\_segments\_and**

c name	c type	Array Element	Description	Units	Range
orbit_id	xo_orbit_id*	-	Structure that contains the orbit data	-	-
orbit_type	long	-	Define the type of orbit representation, i.e. absolute or relative orbits in the input/output parameters	-	Complete (see table 2)
order_switch	long	-	Indicates if the input list is sorted by start times. If input segments are already sorted, the flag should be set to XV_TIME_ORDER to save computation time.	-	Complete (see table 2)
num_segments_1	long	-	Number of segments in the input list 1.	-	>0
bgn_orbit_1	long*	all	Array of orbit numbers for the beginning of the segments in list 1	-	>0
bgn_secs_1	long*	all	Array of seconds elapsed since ANX for the beginning of the segments in list 1	-	>0 <nodal period
bgn_microsecs_1	long*	all	Array of microseconds within a second for the beginning of the segments in list 1	-	>0 <999999
bgn_cycle_1	long*	all	Array of cycle numbers for the beginning of the segments in list 1. When using absolute orbits, a NULL pointer can be used.	-	>0 or NULL
end_orbit_1	long*	all	Array of orbit numbers for the end of the segments in list 1	-	>0
end_secs_1	long*	all	Array of seconds elapsed since ANX for the end of the segments in list 1	-	>0 <nodal period
end_microsecs_1	long*	all	Array of microseconds within a second for the end of the segments in list 1	-	>0 <999999

**Table 36: Input parameters of xv\_time\_segments\_and**

c name	c type	Array Element	Description	Units	Range
end_cycle_1	long*	all	Array of cycle numbers for the end of the segments in list 1. When using absolute orbits, a NULL pointer can be used.	-	>0 or NULL
num_segments_2	long	-	Number of segments in the input list 2.	-	>0
bgn_orbit_2	long*	all	Array of orbit numbers for the beginning of the segments in list 2	-	>0
bgn_secs_2	long*	all	Array of seconds elapsed since ANX for the beginning of the segments in list 2	-	>0 <nodal period
bgn_microsecs_2	long*	all	Array of microseconds within a second for the beginning of the segments in list 2	-	>0 <999999
bgn_cycle_2	long*	all	Array of cycle numbers for the beginning of the segments in list 2. When using absolute orbits, a NULL pointer can be used.	-	>0 or NULL
end_orbit_2	long*	all	Array of orbit numbers for the end of the segments in list 2	-	>0
end_secs_2	long*	all	Array of seconds elapsed since ANX for the end of the segments in list 2	-	>0 <nodal period
end_microsecs_2	long*	all	Array of microseconds within a second for the end of the segments in list 2	-	>0 <999999
end_cycle_2	long*	all	Array of cycle numbers for the end of the segments in list 2. When using absolute orbits, a NULL pointer can be used.	-	>0 or NULL

## 7.12.4 Output parameters *xv\_time\_segments\_and*

**Table 37: Output parameters of *xv\_time\_segments\_and***

c name	c type	Array Element	Description	Unit	Range
<i>xv_time_segments_and</i>	long		Function status flag, = 0 No error > 0 Warnings, results generated < 0 Error, no results generated		
<i>num_segments_out</i>	long	-	Number of segments in the output list.	-	>0
<i>bgn_orbit_out</i>	long*	all	Array of orbit numbers for the beginning of the segments	-	>0
<i>bgn_secs_out</i>	long*	all	Array of seconds elapsed since ANX for the beginning of the segments	-	>0 <nodal period
<i>bgn_microsecs_out</i>	long*	all	Array of microseconds within a second for the beginning of the segments	-	>0 <999999
<i>bgn_cycle_out</i>	long*	all	Array of cycle numbers for the beginning of the segments.	-	>0
<i>end_orbit_out</i>	long*	all	Array of orbit numbers for the end of the segments	-	>0
<i>end_secs_out</i>	long*	all	Array of seconds elapsed since ANX for the end of the segments	-	>0 <nodal period
<i>end_microsecs_out</i>	long*	all	Array of microseconds within a second for the end of the segments	-	>0 <999999
<i>end_cycle_out</i>	long*	all	Array of cycle numbers for the end of the segments.	-	>0 or NULL
<i>ierr[10]</i>	long		Error status flags		

**Memory Management:** Note that the output visibility segments arrays are pointers to integers instead of static arrays. The memory for these dynamic arrays is allocated within the *xv\_time\_segments\_and* function. So the user will only have to declare those pointers but not to allocate memory for them. However, once the function has returned without error, the user will have the responsibility of freeing the memory for those pointers once they are not used.

### 7.12.5 Warnings and errors

Next table lists the possible error messages that can be returned by the **xv\_time\_segments\_and** CFI function after translating the returned status vector into the equivalent list of error messages by calling the function of the EXPLORER\_VISIBILITY software library **xv\_get\_msg**.

This table also indicates the type of message returned, i.e. either a warning (WARN) or an error (ERR), the cause of such a message and the impact on the performed calculation, mainly on the results vector.

The table is completed by the error code and value. These error codes can be obtained translating the status vector returned by the **xv\_time\_segments\_and** CFI function by calling the function of the EXPLORER\_VISIBILITY software library **xv\_get\_code**.

Error type	Error message	Cause and impact	Error Code	Error No
ERR	Error allocating internal memory.	Computation not performed	XV_CFI_TIME_SEGMENTS_AND_MEMORY_ERR	
ERR	Error getting absolute orbit vector from relative orbits.	Computation not performed	XV_CFI_TIME_SEGMENTS_AND_REL_TO_ABS_ORBIT_ERR	
ERR	Error getting relative orbit vector from absolute orbits.	Computation not performed	XV_CFI_TIME_SEGMENTS_AND_ABS_TO_REL_ORBIT_ERR	
ERR	Error sorting input list.	Computation not performed	XV_CFI_TIME_SEGMENTS_AND_SORTING_ERR	



---

### ***7.12.6 Runtime performances***

The following runtime performance has been measured.

*Table 38: Runtime performances of xv\_time\_segments\_and function*

Ultra Sparc [ms]
TBD

## 7.13 xv\_time\_segments\_sort

### 7.13.1 Overview

An orbital segment is a time interval along the orbit, defined by start and stop times expressed as an orbit number and the seconds elapsed since the ascending node crossing.

The **xv\_time\_segments\_sort** function sorts a list of orbital segments following two different criteria:

- Absolute orbits: the segments are sorted by their start time
- Relative orbits

The time intervals used by **xv\_time\_segments\_sort** can be expressed in absolute or relative orbit numbers. This is valid for both:

- input parameter: first and last orbit to be considered. In case of using relative orbits, the corresponding cycle numbers should be used, otherwise, the cycle number will be a dummy parameter.
- output parameter: time segments with time expressed as {absolute orbit number (or relative orbit and cycle number), number of seconds since ANX, number of microseconds}

The orbit representation (absolute or relative) for the output segments will be the same as in the input orbits. Note that the sort criteria does not have any relation with the chosen orbit representation. The following example clarifies this:

Input orbits: 6, 8, 4, 5, 9, 3 (absolute)

Let's suppose that the cycle length is 4 orbits. Then the relative orbits are:

input orbits: 2, 4, 4, 1, 1, 3 (relative)

When ordering this array, we have the following possibilities (table 39) depending on the orbit representation and the sort criteria chosen:

**Table 39: xv\_time\_segments\_sort function**

Input	Sort Criteria	Output
absolute orbits 6, 8, 4, 5, 9, 3	absolute orbits	absolute orbits 3, 4, 5, 6, 8, 9
	relative orbits	absolute orbits 5, 9, 6, 3, 4, 8
relative orbits 2, 4, 4, 1, 1, 3	absolute orbits	relative orbits 3, 4, 1, 2, 4, 1
	relative orbits	relative orbits 1, 1, 2, 3, 4, 4

The **xv\_time\_segments\_sort** requires access the following files to produce its results:

- the Orbit Scenario File: only if the orbits are expressed in relative numbers.

### 7.13.2 Calling sequence `xv_time_segments_sort`

For C programs, the call to `xv_time_segments_sort` is (input parameters are underlined):

```
#include "explorer_visibility.h"
{

    xo_orbit_id  orbit_id = {NULL};
    long         orbit_type, sort_criteria,
               num_segments,
               *bgn_orbit, *bgn_secs,
               *bgn_microsecs, *bgn_cycle,
               *end_orbit, *end_secs,
               *end_microsecs, *end_cycle,
               ierr, status;

    status = xv_time_segments_sort (
        &orbit_id,
        &orbit_type, &sort_criteria,
        &number_segments,
        bgn_orbit, bgn_second,
        bgn_microsec, bgn_cycle,
        end_orbit, end_second,
        end_microsec, end_cycle,
        ierr);

    /* Or, using the run_id */
    long run_id;

    status = xv_time_segments_sort_run (
        &run_id,
        &orbit_type, &sort_criteria,
        &number_segments,
        bgn_orbit, bgn_second,
        bgn_microsec, bgn_cycle,
        end_orbit, end_second,
        end_microsec, end_cycle,
        ierr);
}
```

For FORTRAN programs **xv\_time\_segments\_sort** has the following calling sequence (input parameters are underlined, note that the C preprocessor must be used because of the presence of the #include statement):

```

      INTEGER*4    SAT_ID, ORBIT_TYPE, ORDER_SWITCH,
&                NUM_SEGMENTS,
&                BGN_ORBIT, BGN_SECS,
&                BGN_MICROSECS, BGN_CYCLE,
&                END_ORBIT, END_SECS,
&                END_MICROSECS, END_CYCLE,
&                IERR(XV_NUM_ERR_AND), STATUS
      CHARACTER*(*)ORBIT_SCENARIO_FILE
  
```

```
#include"explorer_visibility.inc"
```

```

      STATUS = XV_TIME_SEGMENTS_SORT(
&                SAT_ID, ORBIT_SCENARIO_FILE,
&                ORBIT_TYPE, ORDER_SWITCH,
&                NUMBER_SEGMENTS,
&                BGN_ORBIT, BGN_SECS,
&                BGN_MICROSECS, BGN_CYCLE,
&                END_ORBIT, END_SECS,
&                END_MICROSECS, END_CYCLE,
&                IERR)
  
```

```
C test status
```

### 7.13.3 Input parameters *xv\_time\_segments\_sort*

**Table 40: Input parameters of *xv\_time\_segments\_sort***

c name	c type	Array Element	Description	Units	Range
orbit_id	xo_orbit_id*	-	Structure that contains the orbit data	-	-
orbit_type	long	-	Define the type of orbit representation, i.e. absolute or relative orbits in the input/output parameters	-	Complete (see table 2)
sort_criteria	long	-	sorting criteria to be used: absolute or relative orbits	-	Complete (see table 2)
num_segments	long	-	Number of segments in the input.	-	>0
bgn_orbit	long*	all	Array of orbit numbers for the beginning of the segments	-	>0
bgn_secs	long*	all	Array of seconds elapsed since ANX for the beginning of the segments	-	>0 <nodal period
bgn_microsecs	long*	all	Array of microseconds within a second for the beginning of the segments	-	>0 <999999
bgn_cycle	long*	all	Array of cycle numbers for the beginning of the segments. When using absolute orbits, a NULL pointer can be used.	-	>0 or NULL
end_orbit	long*	all	Array of orbit numbers for the end of the segments	-	>0
end_secs	long*	all	Array of seconds elapsed since ANX for the end of the segments	-	>0 <nodal period
end_microsecs	long*	all	Array of microseconds within a second for the end of the segments.	-	>0 <999999
end_cycle	long*	all	Array of cycle numbers for the end of the segments. When using absolute orbits, a NULL pointer can be used.	-	>0 or NULL

### 7.13.4 Output parameters *xv\_time\_segments\_sort*

Table 41: Output parameters of *xv\_time\_segments\_sort*

c name	c type	Array Element	Description	Unit	Range
<i>xv_time_segments_and</i>	long		Function status flag, = 0 No error > 0 Warnings, results generated < 0 Error, no results generated		
<i>ierr[10]</i>	long		Error status flags		

### 7.13.5 Warnings and errors

Next table lists the possible error messages that can be returned by the **xv\_time\_segments\_sort** CFI function after translating the returned status vector into the equivalent list of error messages by calling the function of the EXPLORER\_VISIBILITY software library **xv\_get\_msg**.

This table also indicates the type of message returned, i.e. either a warning (WARN) or an error (ERR), the cause of such a message and the impact on the performed calculation, mainly on the results vector.

The table is completed by the error code and value. These error codes can be obtained translating the status vector returned by the **xv\_time\_segments\_sort** CFI function by calling the function of the EXPLORER\_VISIBILITY software library **xv\_get\_code**.

Error type	Error message	Cause and impact	Error Code	Error No
ERR	Error allocating internal memory.	Computation not performed	XV_CFI_TIME_SEGMENTS_SORT_MEMORY_ERR	0
ERR	Error getting absolute orbit vector from relative orbits.	Computation not performed	XV_CFI_TIME_SEGMENTS_SORT_CHANGING_ORBIT_ERR	1

---

### 7.13.6 Runtime performances

The following runtime performance has been measured.

*Table 42: Runtime performances of xv\_time\_segments\_sort function*

Ultra Sparc [ms]
TBD



## 7.14 xv\_time\_segments\_merge

### 7.14.1 Overview

An orbital segment is a time interval along the orbit, defined by start and stop times expressed as an orbit number and the seconds elapsed since the ascending node crossing.

The **xv\_time\_segments\_merge** function merges all the overlapped segments within a list (see Figure 16)

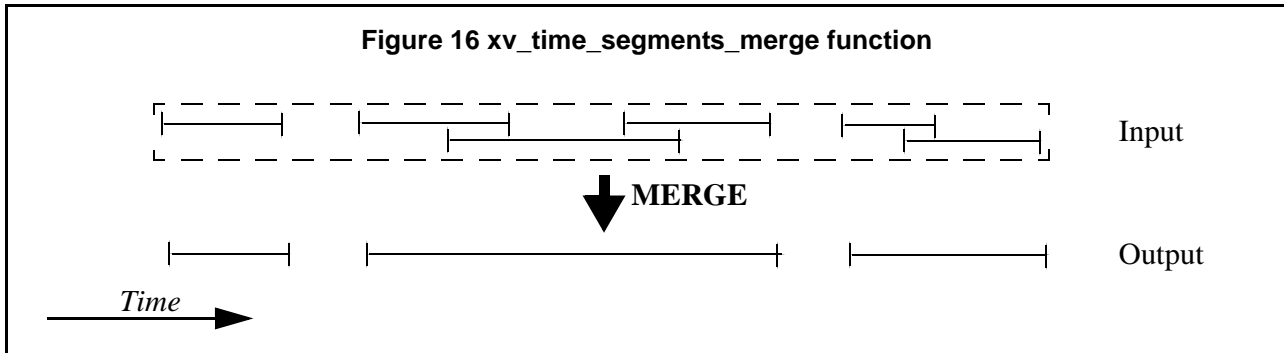

The input segments list need to be sorted according to the start time of the segments. If this list is not sorted, it should be indicated in the function interface with the corresponding parameter (see below). In this case the input list will be modified accordingly.

The time intervals used by **xv\_time\_segments\_merge** can be expressed in absolute or relative orbit numbers. This is valid for both:

- input parameter: first and last orbit to be considered. In case of using relative orbits, the corresponding cycle numbers should be used, otherwise, the cycle number will be a dummy parameter.
- output parameter: time segments with time expressed as {absolute orbit number (or relative orbit and cycle number), number of seconds since ANX, number of microseconds}

The orbit representation (absolute or relative) for the output segments will be the same as in the input orbits. Moreover, the segments will be ordered chronologically.

The **xv\_time\_segments\_merge** requires access to the following files to produce its results:

- the Orbit Scenario File: only if the orbits are expressed in relative numbers.

## 7.14.2 Calling sequence *xv\_time\_segments\_merge*

For C programs, the call to **xv\_time\_segments\_merge** is (input parameters are underlined):

```
#include "explorer_visibility.h"
{

    xo_orbit_id  orbit_id = {NULL};
    long        orbit_type, order_switch,
               num_segments,
               *bgn_orbit, *bgn_secs,
               *bgn_microsecs, *bgn_cycle,
               *end_orbit, *end_secs,
               *end_microsecs, *end_cycle,
               num_segments_out,
               *bgn_orbit_out, *bgn_secs_out,
               *bgn_microsecs_out, *bgn_cycle_out,
               *end_orbit_out, *end_secs_out,
               *end_microsecs_out, *end_cycle_out,
               ierr[XV_NUM_ERR_MERGE], status;

    status = xv_time_segments_merge(
        &orbit_id,
        &orbit_type, &order_switch,
        &number_segments,
        bgn_orbit, bgn_secs,
        bgn_microsecs, bgn_cycle,
        end_orbit, end_secs,
        end_microsecs, end_cycle,
        &num_segments_out,
        &bgn_orbit_out, &bgn_secs_out,
        &bgn_microsecs_out, &bgn_cycle_out,
        &end_orbit_out, &end_secs_out,
        &end_microsecs_out, &end_cycle_out,
        ierr);

    /* Or, using the run_id */
    long run_id;

    status = xv_time_segments_merge_run(
        &run_id,
        &orbit_type, &order_switch,
        &number_segments,
        bgn_orbit, bgn_secs,
        bgn_microsecs, bgn_cycle,
        end_orbit, end_secs,
        end_microsecs, end_cycle,
        &num_segments_out,
```

```

        &bgn_orbit_out, &bgn_secs_out,
        &bgn_microsecs_out, &bgn_cycle_out,
        &end_orbit_out, &end_secs_out,
        &end_microsecs_out, &end_cycle_out,
        ierr);
}

```

For FORTRAN programs **xv\_time\_segments\_merge** has the following calling sequence (input parameters are underlined, note that the C preprocessor must be used because of the presence of the #include statement):

```

INTEGER*4    SAT_ID, ORBIT_TYPE, ORDER_SWITCH,
&           NUM_SEGMENTS,
&           BGN_ORBIT, BGN_SECS,
&           BGN_MICROSECS, BGN_CYCLE,
&           END_ORBIT, END_SECS,
&           END_MICROSECS, END_CYCLE,
&           NUM_SEGMENTS_OUT,
&           BGN_ORBIT_OUT, BGN_SECS_OUT,
&           BGN_MICROSECS_OUT, BGN_CYCLE_OUT,
&           END_ORBIT_OUT, END_SECS_OUT,
&           END_MICROSECS_OUT, END_CYCLE_OUT,
&           IERR(XV_NUM_ERR_MERGE), STATUS;
CHARACTER*(*)ORBIT_SCENARIO_FILE

```

```
#include"explorer_visibility.inc"
```

```

STATUS = XV_TIME_SEGMENTS_MERGE(
&           SAT_ID, ORBIT_SCENARIO_FILE,
&           ORBIT_TYPE, ORDER_SWITCH,
&           NUMBER_SEGMENTS,
&           BGN_ORBIT, BGN_SECS,
&           BGN_MICROSECS, BGN_CYCLE,
&           END_ORBIT, END_SECS,
&           END_MICROSECS, END_CYCLE,
&           NUM_SEGMENTS_OUT,
&           BGN_ORBIT_OUT, BGN_SECS_OUT,
&           BGN_MICROSECS_OUT, BGN_CYCLE_OUT,
&           END_ORBIT_OUT, END_SECS_OUT,
&           END_MICROSECS_OUT, END_CYCLE_OUT,
&           IERR)

```

```
C test status
```

### 7.14.3 Input parameters *xv\_time\_segments\_merge*

**Table 43: Input parameters of *xv\_time\_segments\_merge***

c name	c type	Array Element	Description	Units	Range
orbit_id	xo_orbit_id*	-	Structure that contains the orbit data	-	-
orbit_type	long	-	Define the type of orbit representation, i.e. absolute or relative orbits in the input/output parameters	-	Complete (see table 2)
order_switch	long	-	Indicates if the input list is sorted by start times. If input segments are already sorted, the flag should be set to <i>XV_TIME_ORDER</i> to save computation time.	-	Complete (see table 2)
num_segments_in	long	-	Number of segments in the input list.	-	>0
bgn_orbit	long*	all	Array of orbit numbers for the beginning of the segments	-	>0
bgn_secs	long*	all	Array of seconds elapsed since ANX for the beginning of the segments	-	>0 <nodal period
bgn_microsecs	long*	all	Array of microseconds within a second for the beginning of the segments	-	>0 <999999
bgn_cycle	long*	all	Array of cycle numbers for the beginning of the segments. When using absolute orbits, a NULL pointer can be used.	-	>0 or NULL
end_orbit	long*	all	Array of orbit numbers for the end of the segments	-	>0
end_secs	long*	all	Array of seconds elapsed since ANX for the end of the segments	-	>0 <nodal period
end_microsecs	long*	all	Array of microseconds within a second for the end of the segments	-	>0 <999999

**Table 43: Input parameters of xv\_time\_segments\_merge**

c name	c type	Array Element	Description	Units	Range
end_cycle	long*	all	Array of cycle numbers for the end of the segments. When using absolute orbits, a NULL pointer can be used.	-	>0 or NULL

## 7.14.4 Output parameters *xv\_time\_segments\_merge*

Table 44: Output parameters of *xv\_time\_segments\_merge*

c name	c type	Array Element	Description	Unit	Range
<i>xv_time_segments_merge</i>	long		Function status flag, = 0 No error > 0 Warnings, results generated < 0 Error, no results generated		
<i>num_segments_out</i>	long	-	Number of segments in the output list.	-	>0
<i>bgn_orbit_out</i>	long*	all	Array of orbit numbers for the beginning of the segments	-	>0
<i>bgn_secs_out</i>	long*	all	Array of seconds elapsed since ANX for the beginning of the segments	-	>0 <nodal period
<i>bgn_microsecs_out</i>	long*	all	Array of microseconds within a second for the beginning of the segments	-	>0 <999999
<i>bgn_cycle_out</i>	long*	all	Array of cycle numbers for the beginning of the segments.	-	>0
<i>end_orbit_out</i>	long*	all	Array of orbit numbers for the end of the segments	-	>0
<i>end_secs_out</i>	long*	all	Array of seconds elapsed since ANX for the end of the segments	-	>0 <nodal period
<i>end_microsecs_out</i>	long*	all	Array of microseconds within a second for the end of the segments	-	>0 <999999
<i>end_cycle_out</i>	long*	all	Array of cycle numbers for the end of the segments.	-	>0 or NULL
<i>ierr[10]</i>	long		Error status flags		

**Memory Management:** Note that the output visibility segments arrays are pointers to integers instead of static arrays. The memory for these dynamic arrays is allocated within the ***xv\_time\_segments\_merge*** function. So the user will only have to declare those pointers but not to allocate memory for them. However, once the function has returned without error, the user will have the responsibility of freeing the memory for those pointers once they are not used.

### 7.14.5 Warnings and errors

Next table lists the possible error messages that can be returned by the **xv\_time\_segments\_merge** CFI function after translating the returned status vector into the equivalent list of error messages by calling the function of the EXPLORER\_VISIBILITY software library **xv\_get\_msg**.

This table also indicates the type of message returned, i.e. either a warning (WARN) or an error (ERR), the cause of such a message and the impact on the performed calculation, mainly on the results vector.

The table is completed by the error code and value. These error codes can be obtained translating the status vector returned by the **xv\_time\_segments\_merge** CFI function by calling the function of the EXPLORER\_VISIBILITY software library **xv\_get\_code**.

Error type	Error message	Cause and impact	Error Code	Error No
ERR	Error allocating internal memory.	Computation not performed	XV_CFI_TIME_SEGMENTS_MERGE_MEMORY_ERR	0
ERR	Error getting absolute orbit vector from relative orbits.	Computation not performed	XV_CFI_TIME_SEGMENTS_MERGE_REL_TO_ABS_ORBIT_ERR	1
ERR	Error getting relative orbit vector from absolute orbits.	Computation not performed	XV_CFI_TIME_SEGMENTS_MERGE_ABS_TO_REL_ORBIT_ERR	2
ERR	Error sorting input list.	Computation not performed	XV_CFI_TIME_SEGMENTS_MERGE_SORTING_ERR	3

---

### 7.14.6 Runtime performances

The following runtime performance has been measured.

*Table 45: Runtime performances of xv\_time\_segments\_merge function*

Ultra Sparc [ms]
TBD



---

## 7.15 xv\_time\_segments\_delta

### 7.15.1 Overview

An orbital segment is a time interval along the orbit, defined by start and stop times expressed as an orbit number and the seconds elapsed since the ascending node crossing.

The **xv\_time\_segments\_delta** function makes all the segments within a list, longer or shorter. After increasing/decreasing the longitude of the segments, these are sorted and merged to avoid possible overlapping. Therefore, at the end the list is sorted and without overlapped segments.

The time intervals used by **xv\_time\_segments\_delta** can be expressed in absolute or relative orbit numbers. This is valid for both:

- input parameter: first and last orbit to be considered. In case of using relative orbits, the corresponding cycle numbers should be used, otherwise, the cycle number will be a dummy parameter.
- output parameter: time segments with time expressed as {absolute orbit number (or relative orbit and cycle number), number of seconds since ANX, number of microseconds}

The orbit representation (absolute or relative) for the output segments will be the same as in the input orbits.

The **xv\_time\_segments\_delta** requires access to the following files to produce its results:

- the Orbit Scenario File: only if the orbits are expressed in relative numbers.

## 7.15.2 Calling sequence *xv\_time\_segments\_delta*

For C programs, the call to `xv_time_segments_delta` is (input parameters are underlined):

```
#include "explorer_visibility.h"
{
    xo_orbit_id  orbit_id = {NULL};
    long         orbit_type,
                num_segments,
                *bgn_orbit, *bgn_secs,
                *bgn_microsecs, *bgn_cycle,
                *end_orbit, *end_secs,
                *end_microsecs, *end_cycle,
                num_segments_out,
                *bgn_orbit_out, *bgn_secs_out,
                *bgn_microsecs_out, *bgn_cycle_out,
                *end_orbit_out, *end_secs_out,
                *end_microsecs_out, *end_cycle_out,
                ierr[XV_NUM_ERR_DELTA], status;
    double      entry_offset, exit_offset;

    status = xv_time_segments_delta(
                &orbit_id,
                &orbit_type,
                &entry_offset, &exit_offset,
                &number_segments,
                &bgn_orbit, &bgn_secs,
                &bgn_microsecs, &bgn_cycle,
                &end_orbit, &end_secs,
                &end_microsecs, &end_cycle,
                &num_segments_out,
                &bgn_orbit_out, &bgn_secs_out,
                &bgn_microsecs_out, &bgn_cycle_out,
                &end_orbit_out, &end_secs_out,
                &end_microsecs_out, &end_cycle_out,
                ierr);

    /* Or, using the run_id */
    long run_id;

    status = xv_time_segments_delta_run(
                &run_id,
                &orbit_type,
                &entry_offset, &exit_offset,
                &number_segments,
                &bgn_orbit, &bgn_secs,
                &bgn_microsecs, &bgn_cycle,
                &end_orbit, &end_secs,
```

```

        end_microsecs, end_cycle,
        &num_segments_out,
        &bgn_orbit_out, &bgn_secs_out,
        &bgn_microsecs_out, &bgn_cycle_out,
        &end_orbit_out, &end_secs_out,
        &end_microsecs_out, &end_cycle_out,
        ierr);
}

```

For FORTRAN programs **xv\_time\_segments\_delta** has the following calling sequence (input parameters are underlined, note that the C preprocessor must be used because of the presence of the #include statement):

```

      INTEGER*4   SAT_ID, ORBIT_TYPE,
&               DELTA_SECS, DELTA_MICROSECS,
&               NUM_SEGMENTS,
&               *BGN_ORBIT, *BGN_SECS,
&               *BGN_MICROSECS, *BGN_CYCLE,
&               *END_ORBIT, *END_SECS,
&               *END_MICROSECS, *END_CYCLE,
&               NUM_SEGMENTS_OUT,
&               *BGN_ORBIT_OUT, *BGN_SECS_OUT,
&               *BGN_MICROSECS_OUT, *BGN_CYCLE_OUT,
&               *END_ORBIT_OUT, *END_SECS_OUT,
&               *END_MICROSECS_OUT, *END_CYCLE_OUT,
&               IERR(XV_NUM_ERR_DELTA), STATUS;
      CHARACTER*(*)ORBIT_SCENARIO_FILE

```

```
#include"explorer_visibility.inc"
```

```

      STATUS = XV_TIME_SEGMENTS_DELTA(
&           SAT_ID, ORBIT_SCENARIO_FILE,
&           ORBIT_TYPE,
&           ENTRY_OFFSET, EXIT_OFFSET,
&           NUMBER_SEGMENTS,
&           BGN_ORBIT, BGN_SECS,
&           BGN_MICROSECS, BGN_CYCLE,
&           END_ORBIT, END_SECS,
&           END_MICROSECS, END_CYCLE,
&           NUM_SEGMENTS_OUT,
&           BGN_ORBIT_OUT, BGN_SECS_OUT,
&           BGN_MICROSECS_OUT, BGN_CYCLE_OUT,
&           END_ORBIT_OUT, END_SECS_OUT,
&           END_MICROSECS_OUT, END_CYCLE_OUT,
&           IERR)

```

C test status

### 7.15.3 Input parameters *xv\_time\_segments\_delta*

Table 46: Input parameters of *xv\_time\_segments\_delta*

c name	c type	Array Element	Description	Units	Range
orbit_id	xo_orbit_id*	-	Structure that contains the orbit data	-	-
orbit_type	long	-	Define the type of orbit representation, i.e. absolute or relative orbits in the input/output parameters	-	Complete (see table 2)
entry_offset	double		Number of seconds to add/subtract at the beginning of every segments. If entry_offset > 0, the entry_offset is added at the beginning of the segments making them shorter.	seconds	-
exit_offset	double		Number of seconds to add/subtract at the end of every segments. If exit_offset > 0 the exit_offset is added at the end of the segments making them longer.	seconds	-
num_segments_in	long	-	Number of segments in the input list.	-	>0
bgn_orbit	long*	all	Array of orbit numbers for the beginning of the segments	-	>0
bgn_secs	long*	all	Array of seconds elapsed since ANX for the beginning of the segments	-	>0 <nodal period
bgn_microsecs	long*	all	Array of microseconds within a second for the beginning of the segments	-	>0 <999999
bgn_cycle	long*	all	Array of cycle numbers for the beginning of the segments. When using absolute orbits, a NULL pointer can be used.	-	>0 or NULL
end_orbit	long*	all	Array of orbit numbers for the end of the segments	-	>0

**Table 46: Input parameters of xv\_time\_segments\_delta**

c name	c type	Array Element	Description	Units	Range
end_secs	long*	all	Array of seconds elapsed since ANX for the end of the segments	-	>0 <nodal period
end_microsecs	long*	all	Array of microseconds within a second for the end of the segments	-	>0 <999999
end_cycle	long*	all	Array of cycle numbers for the end of the segments. When using absolute orbits, a NULL pointer can be used.	-	>0 or NULL

### 7.15.4 Output parameters *xv\_time\_segments\_delta*

Table 47: Output parameters of *xv\_time\_segments\_delta*

c name	c type	Array Element	Description	Unit	Range
<i>xv_time_segments_delta</i>	long		Function status flag, = 0 No error > 0 Warnings, results generated < 0 Error, no results generated		
<i>num_segments_out</i>	long	-	Number of segments in the output list.	-	>0
<i>bgn_orbit_out</i>	long*	all	Array of orbit numbers for the beginning of the segments	-	>0
<i>bgn_secs_out</i>	long*	all	Array of seconds elapsed since ANX for the beginning of the segments	-	>0 <nodal period
<i>bgn_microsecs_out</i>	long*	all	Array of microseconds within a second for the beginning of the segments	-	>0 <999999
<i>bgn_cycle_out</i>	long*	all	Array of cycle numbers for the beginning of the segments.	-	>0
<i>end_orbit_out</i>	long*	all	Array of orbit numbers for the end of the segments	-	>0
<i>end_secs_out</i>	long*	all	Array of seconds elapsed since ANX for the end of the segments	-	>0 <nodal period
<i>end_microsecs_out</i>	long*	all	Array of microseconds within a second for the end of the segments	-	>0 <999999
<i>end_cycle_out</i>	long*	all	Array of cycle numbers for the end of the segments.	-	>0 or NULL
<i>ierr[10]</i>	long		Error status flags		

**Memory Management:** Note that the output visibility segments arrays are pointers to integers instead of static arrays. The memory for these dynamic arrays is allocated within the *xv\_time\_segments\_delta* function. So the user will only have to declare those pointers but not to allocate memory for them. However, once the function has returned without error, the user will have the responsibility of freeing the memory for those pointers once they are not used.

### 7.15.5 Warnings and errors

Next table lists the possible error messages that can be returned by the **xv\_time\_segments\_delta** CFI function after translating the returned status vector into the equivalent list of error messages by calling the function of the EXPLORER\_VISIBILITY software library **xv\_get\_msg**.

This table also indicates the type of message returned, i.e. either a warning (WARN) or an error (ERR), the cause of such a message and the impact on the performed calculation, mainly on the results vector.

The table is completed by the error code and value. These error codes can be obtained translating the status vector returned by the **xv\_time\_segments\_delta** CFI function by calling the function of the EXPLORER\_VISIBILITY software library **xv\_get\_code**.

Error type	Error message	Cause and impact	Error Code	Error No
ERR	Error allocating internal memory	Computation not performed	XV_CFI_TIME_SEGMENTS_DELTA_MEMORY_ERR	0
ERR	Error getting absolute orbit vector from relative orbits	Computation not performed	XV_CFI_TIME_SEGMENTS_DELTA_REL_TO_ABS_ERR	1
ERR	Error getting relative orbit vector from absolute orbits	Computation not performed	XV_CFI_TIME_SEGMENTS_DELTA_ABS_TO_REL_ERR	2
ERR	Error transforming from orbits to processing times.	Computation not performed	XV_CFI_TIME_SEGMENTS_DELTA_ORBIT_TO_TIME_ERR	3
ERR	Error transforming from processing times to orbits.	Computation not performed	XV_CFI_TIME_SEGMENTS_DELTA_TIME_TO_ORBIT_ERR	4
ERR	Error modifying time segment duration	Computation not performed	XV_CFI_TIME_SEGMENTS_DELTA_TIME_ADD_ERR	5
ERR	Error sorting input list	Computation not performed	XV_CFI_TIME_SEGMENTS_DELTA_SORT_ERR	6

---

### ***7.15.6 Runtime performances***

The following runtime performance has been measured.

*Table 48: Runtime performances of xv\_time\_segments\_delta function*

Ultra Sparc [ms]
TBD



## 7.16 xv\_time\_segments\_mapping

### 7.16.1 Overview

The function **xv\_time\_segments\_mapping** returns groups of visibility segments of a zone within an orbit range introduced by the user. These groups, or mappings, contain a minimum number of time segments needed to cover the zone completely, and fulfil the following conditions:

- Each mapping only contains ascending or descending segments.
- The segments are ordered by the track number.
- Mappings with one segment will be returned if it covers completely the zone.
- A mapping is searched for each track with segments that only contains left/right coverage in the case of ascending/descending segments, and finishes with a track that only contains right/left coverage.
- Incomplete mappings are not returned. This could happen if the number of orbits is insufficient to cover the zone.

Note that different mappings could contain a subset of segments in common. For example in figure 17 there are two possible different mappings:

- mapping 1: orbits 1, 2, 3, 4.
- mapping 2: orbits 502, 2, 3, 4.

**Figure 17 Different mappings with common segments**

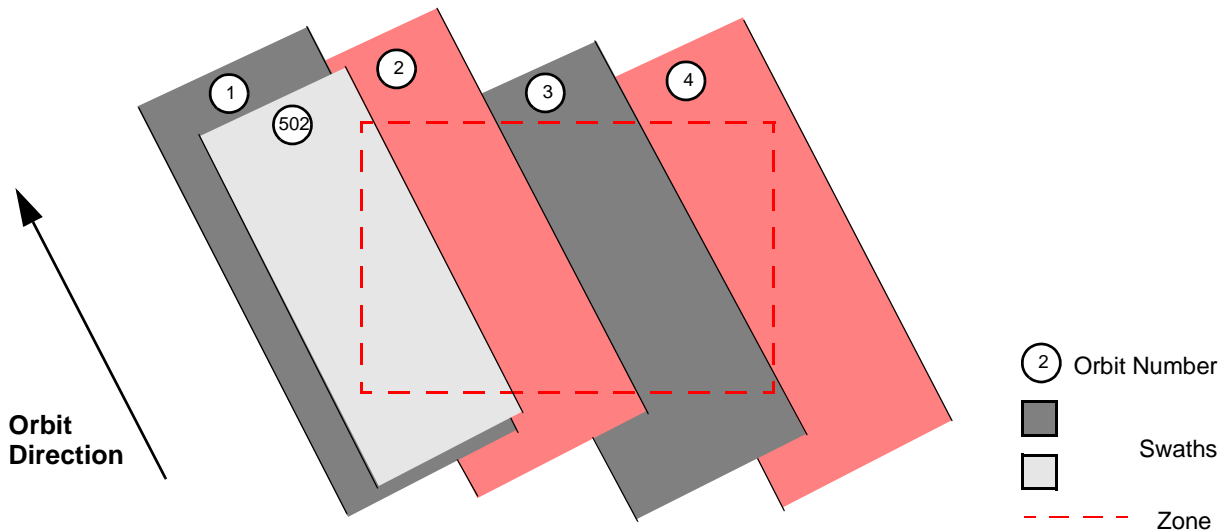

The time intervals used by **xv\_time\_segments\_mapping** can be expressed in absolute or relative orbit numbers. This is valid for both:

- input parameter: first and last orbit to be considered. In case of using relative orbits, the corresponding cycle numbers should be used, otherwise, the cycle number will be a dummy parameter.
- output parameter: time segments with time expressed as {absolute orbit number (or relative orbit and cycle number), number of seconds since ANX, number of microseconds}

The orbit representation (absolute or relative) for the output segments will be the same as in the input orbits.

The **xv\_time\_segments\_mapping** requires access to several data structures and files to produce its results:

- the **orbit\_id** (**xo\_orbit\_id**) providing the orbital data. The **orbit\_id** can be initialized with the following data or files (see [ORBIT\_SUM]):
  - data for an orbital change
  - Orbit scenario files
  - Predicted orbit files
  - Orbit Event Files
  - Restituted orbit files
  - DORIS Preliminary orbit files
  - DORIS Navigator files
- the Instrument Swath File, excluding inertial swath files, describing the area seen by the relevant instrument all along the current orbit. The Swath data can be provided by:
  - A swath template file produced off-line by the EXPLORER\_VISIBILITY library (**xv\_gen\_swath** function).
  - A swath definition file, describing the swath geometry. In this case the **xv\_time\_segments\_mapping** generates the swath points for a number of orbits given by the user.
- Zone Database File: just in case of using a zone from the data base.

## 7.16.2 Calling sequence `xv_time_segments_mapping`

For C programs, the call to `xv_time_segments_mapping` is (input parameters are underlined):

```
#include "explorer_visibility.h"
{
    xo_orbit_id   orbit_id = {NULL};
    long         swath_flag, orbit_type,
               start_orbit, start_cycle,
               stop_orbit, stop_cycle,
               zone_num, projection;
    num_mappings, *num_segments,
    *orbit_direction,
    **bgn_orbit, **bgn_secs,
    **bgn_microsec, **bgn_cycle,
    **end_orbit, **end_secs,
    **end_microsec, **end_cycle,
    **coverage,
    ierr[XV_NUM_ERR_MAPPING], status;

    double      zone_diam, *zone_long, *zone_lat;

    char        *swath_file,
               zone_id[9], *zone_db_file;

    status = xv_time_segments_mapping(
        &orbit_id, &orbit_type,
        &start_orbit, &start_cycle,
        &stop_orbit, &stop_cycle,
        &swath_flag, swath_file,
        &zone_num, zone_id, zone_db_file,
        &projection, &zone_diam, zone_long, zone_lat,
        &num_mappings, &num_segments,
        &orbit_direction,
        &bgn_orbit, &bgn_secs, &bgn_microsec, &bgn_cycle,
        &end_orbit, &end_secs, &end_microsec, &end_cycle,
        &coverage, ierr);

    /* Or, using the run_id */
    long run_id;
```

---

```
status = xv_time_segments_mapping_run(  
    &run_id, &orbit_type,  
    &start_orbit, &start_cycle,  
    &stop_orbit, &stop_cycle,  
    &swath_flag, swath_file,  
    &zone_num, zone_id, zone_db_file,  
    &projection, &zone_diam, zone_long, zone_lat,  
    &num_mappings, &num_segments,  
    &orbit_direction,  
    &bgn_orbit, &bgn_secs, &bgn_microsec, &bgn_cycle,  
    &end_orbit, &end_secs, &end_microsec, &end_cycle,  
    &coverage, ierr);  
}
```

For FORTRAN programs **xv\_time\_segments\_mapping** has the following calling sequence (input parameters are underlined, note that the C preprocessor must be used because of the presence of the #include statement):

```

    INTEGER*4  SAT_ID, ORBIT_TYPE,
&            START_ORBIT, START_CYCLE,
&            STOP_ORBIT, STOP_CYCLE,
&            ZONE_NUM, PROJECTION;
&            NUM_MAPPINGS, NUM_SEGMENTS(MAX_MAPPINGS),
&            ORBIT_DIRECTION(MAX_MAPPINGS),
&            BGN_ORBIT(MAX_MAPPINGS, MAX_SEGMENTS),
&            BGN_SECS(MAX_MAPPINGS, MAX_SEGMENTS),
&            BGN_MICROSEC(MAX_MAPPINGS, MAX_SEGMENTS),
&            BGN_CYCLE(MAX_MAPPINGS, MAX_SEGMENTS),
&            END_ORBIT(MAX_MAPPINGS, MAX_SEGMENTS),
&            END_SECS(MAX_MAPPINGS, MAX_SEGMENTS),
&            END_MICROSEC(MAX_MAPPINGS, MAX_SEGMENTS),
&            END_CYCLE(MAX_MAPPINGS, MAX_SEGMENTS),
&            IERR(XV_NUM_ERR_MAPPING), STATUS

    REAL*8  ZONE_DIAM, *ZONE_LONG, *ZONE_LAT

    CHARACTER*9  ZONE_ID
    CHARACTER*(*) *ORBIT_SCENARIO_FILE, *SWATH_FILE,
                  *ZONE_DB_FILE

#include"explorer_visibility.inc"

    STATUS = XV_TIME_SEGMENTS_MAPPING(
&            SAT_ID, ORBIT_SCENARIO_FILE, ORBIT_TYPE,
&            START_ORBIT, START_CYCLE,
&            STOP_ORBIT, STOP_CYCLE,
&            SWATH_FILE, ZONE_NUM, ZONE_ID, ZONE_DB_FILE,
&            PROJECTION, ZONE_DIAM, ZONE_LONG, ZONE_LAT,
&            NUM_MAPPINGS, NUM_SEGMENTS_MAP,
&            ORBIT_DIRECTION,
&            BGN_ORBIT, BGN_SECS, BGN_MICROSEC, BGN_CYCLE,
&            END_ORBIT, END_SECS, END_MICROSEC, END_CYCLE,
&            IERR);
  
```

C test status

### 7.16.3 Input parameters *xv\_time\_segments\_mapping*

Table 49: Input parameters of *xv\_time\_segments\_mapping*

c name	c type	Array Element	Description	Units	Range
orbit_id	xo_orbit_id*	-	Structure that contains the orbit data	-	-
orbit_type	long	-	Define the type of orbit representation, i.e. absolute or relative orbits in the input/output parameters	-	Complete (see table 2)
start_orbit	long	-	First orbit, segment filter Segments will be filtered as from the beginning of first orbit (within orbit range from orbit_scenario_file) First Orbit in the orbit_scenario_file will be used when: <ul style="list-style-type: none"> <li>• Absolute orbit is set to zero.</li> <li>• Relative orbit and cycle number set to zero.</li> </ul>	absolute or relative orbit number	= 0 or: <ul style="list-style-type: none"> <li>• absolute orbits <math>\geq</math> start_osf</li> <li>• relative orbits <math>\leq</math> repeat cycle</li> </ul>
start_cycle	long	-	Cycle number corresponding to the start_orbit. Dummy when using relative orbits	cycle number	= 0 or $\geq$ first cycle in osf

**Table 49: Input parameters of xv\_time\_segments\_mapping**

c name	c type	Array Element	Description	Units	Range
stop_orbit	long	-	<p>Last orbit, segment filter. The final orbit range defined by the start_orbit (start_cycle) and the stop_orbit (stop_cycle) should not exceed one cycle. Otherwise within one mapping there will appear all the orbits that are equal but that belong to different cycles. When:</p> <ul style="list-style-type: none"> <li>• stop_orbit = 0 (for orbit_type = XV_ORBIT_ABS)</li> <li>• stop_orbit = 0 and stop_cycle = 0 (for orbit_type = XV_ORBIT_REL)</li> </ul> <p>the stop_orbit will be set to the minimum value between:</p> <ul style="list-style-type: none"> <li>• the last orbit within the orbital change of the start_orbit.</li> <li>• start_orbit+cycle_length-1 (i.e. the input orbit range will be a complete cycle)</li> </ul>	absolute or relative orbit number	<p>= 0 or:</p> <ul style="list-style-type: none"> <li>• absolute orbits <math>\geq</math> start_osf</li> <li>• relative orbits <math>\leq</math> repeat cycle</li> </ul>
stop_cycle	long	-	Cycle number corresponding to the stop_orbit. Dummy when using relative orbits	cycle number	= 0 or $\geq$ first cycle in osf
swath_flag	long*	-	<p>Define the use of the swath file:</p> <ul style="list-style-type: none"> <li>• 0 = (XV_STF) if the swath file is a swath template file.</li> <li>• &gt; 0 if the swath files is a swath definition file. In this case the swath points are generated for every "swath_flag" orbits</li> </ul>	-	XV_STF = 0 XV_SDF = 1 > 0
swath_file	char *	-	File name of the swath-file for the appropriate instrument mode		
zone_num	long		<p>Number of vertices of the zone provided in zone_long, zone_lat:</p> <ul style="list-style-type: none"> <li>= 0 no vertices provided, use zone_id / zone_db_file</li> <li>= 1 Point / Circular zone,</li> <li>= 2 Line zone</li> <li>&gt; 2 Polygon zone</li> </ul>		$\geq$ 0

**Table 49: Input parameters of xv\_time\_segments\_mapping**

c name	c type	Array Element	Description	Units	Range
zone_id[9]	char		Identification of the zone, as defined in zone_db_file. This parameter is used ONLY IF zone_num = 0		EXACTLY 8 characters
zone_db_file	char *		File name of the zone-database-file. This file is used ONLY IF zone_num = 0		
projection	long		projection used to define polygon sides as straight lines: = 0 Read projection from Zones DB (rectangular projection is used by default if the DB does not contain a projection) = 1 Azimuthal gnomonic = 2 Rectangular lat/long		
zone_diam	double		Zone diameter for circular zones, dummy for other zones If diameter equals 0.0 then zone is Point Zone	m	≥ 0.0
zone_long	double*	all	zone_long[i-1] Geocentric longitude of - circle centre, for circ. zone, i = 1 - point, for point zone, i = 1 - line-end, for line zone, i = 1 or 2 - vertices, for polygon zone, i = 1... zone_num		
zone_lat	double*	all	zone_lat[i-1] Geodetic latitude of - circle centre, for circ. zone, i = 1 - point, for point zone, i = 1 - line-end, for line zone, i = 1 or 2 - vertices, for polygon zone, i = 1... zone_num		



### 7.16.4 Output parameters *xv\_time\_segments\_mapping*

Table 50: Output parameters of *xv\_time\_segments\_mapping*

c name	c type	Array Element	Description	Unit	Range
<i>xv_time_segments_mapping</i>	long		Function status flag, = 0 No error > 0 Warnings, results generated < 0 Error, no results generated		
<i>num_mappings</i>	long		Number of output mappings		• $\geq 0$
<i>num_segments</i>	long*	all	<i>num_segments</i> [n] = number of segments for the n-th mapping. n=0... ( <i>num_mappings</i> -1)	-	> 0
<i>orbit_direction</i>	long*	all	Direction of the segments of a mapping.	-	Complete (see table 2: segment direction)
<i>bgn_orbit</i>	long**	all	Array of orbit numbers for the beginning of the segments	-	>0
<i>bgn_secs</i>	long**	all	Array of seconds elapsed since ANX for the beginning of the segments	-	>0 <nodal period
<i>bgn_microsecs</i>	long**	all	Array of microseconds within a second for the beginning of the segments	-	>0 <999999
<i>bgn_cycle</i>	long**	all	Array of cycle numbers for the beginning of the segments.	-	>0
<i>end_orbit</i>	long**	all	Array of orbit numbers for the end of the segments	-	>0
<i>end_secs</i>	long**	all	Array of seconds elapsed since ANX for the end of the segments	-	>0 <nodal period
<i>end_microsecs</i>	long**	all	Array of microseconds within a second for the end of the segments	-	>0 <999999
<i>end_cycle</i>	long**	all	Array of cycle numbers for the end of the segments.	-	>0 or NULL
<i>coverage</i>	long **	all	coverage of the output segments.	-	complete see table 2

**Table 50: Output parameters of xv\_time\_segments\_mapping**

c name	c type	Array Element	Description	Unit	Range
ierr	long*		Error status flags		

Note 1: The output visibility segments and the coverage are returned as a two-dimensional table where the first index indicates the number of the mapping, and the second one is the number of the segment within the mapping.

Note 2(Memory Management): Note that the output visibility segments arrays are pointers to integers instead of static arrays. The memory for these dynamic arrays is allocated within the **xv\_time\_segments\_mapping** function. So the user will only have to declare those pointers but not to allocate memory for them. However, once the function has returned without error, the user will have the responsibility of freeing the memory for those pointers once they are not used.

### 7.16.5 Warnings and errors

Next table lists the possible error messages that can be returned by the **xv\_time\_segments\_mapping** CFI function after translating the returned status vector into the equivalent list of error messages by calling the function of the EXPLORER\_VISIBILITY software library **xv\_get\_msg**.

This table also indicates the type of message returned, i.e. either a warning (WARN) or an error (ERR), the cause of such a message and the impact on the performed calculation, mainly on the results vector.

The table is completed by the error code and value. These error codes can be obtained translating the status vector returned by the **xv\_time\_segments\_mapping** CFI function by calling the function of the EXPLORER\_VISIBILITY software library **xv\_get\_code**.

Error type	Error message	Cause and impact	Error Code	Error No
ERR	Error, wrong orbit Id.	Computation not performed	XV_CFI_TIME_SEGMENTS_MAPPING_ORBIT_STATUS_ERR	0
ERR	Error getting absolute orbit from relative orbit.	Computation not performed	XV_CFI_TIME_SEGMENTS_MAPPING_REL_TO_ABS_ERR	1
ERR	Error getting relative orbit vector from absolute orbits	Computation not performed	XV_CFI_TIME_SEGMENTS_MAPPING_REF_LATITUDE_ERR	2
ERR	Error computing swath width.	Computation not performed	XV_CFI_TIME_SEGMENTS_MAPPING_SWATH_WIDTH_ERR	3
ERR	Error calling zone_vis_time function	Computation not performed	XV_CFI_TIME_SEGMENTS_MAPPING_ZONE_VISTIME_ERR	4
ERR	Error loading orbit scenario file.	Computation not performed	XV_CFI_TIME_SEGMENTS_MAPPING_LOAD_OSF_ERR	5
ERR	Start orbit is less than first orbit in OSF	Computation not performed	XV_CFI_TIME_SEGMENTS_MAPPING_WRONG_START_ORBIT_ERR	6
ERR	Error, orbits changes found within the input orbit range	Computation not performed	XV_CFI_TIME_SEGMENTS_MAPPING_WRONG_STOP_ORBIT_ERR	7
ERR	Error allocating memory.	Computation not performed	XV_CFI_TIME_SEGMENTS_MAPPING_MEMORY_ERR	8
ERR	Error sorting segments.	Computation not performed	XV_CFI_TIME_SEGMENTS_MAPPING_SORT_ERR	9

Error type	Error message	Cause and impact	Error Code	Error No
ERR	Error getting relative orbit vector from absolute orbits.	Computation not performed	XV_CFI_TIME_SEGMENTS_MAPPING_ABS_TO_REL_ERR	10
WARN	Cannot check segments for start and stop orbits. Incomplete mappings could be generated.	Previous orbit to input start orbit and/or next orbit to the input stop orbit are not in the same orbital change that the input orbit range. It can not be checked whether there are segments missing at the extremes of the orbit range.  Computation performed.	XV_CFI_TIME_SEGMENTS_MAPPING_NO_CHECK_PERFORMED_WARN	11
ERR	Error checking extremes of the orbit range.	Computation not performed	XV_CFI_TIME_SEGMENTS_MAPPING_CHECK_EXTREMES_ERR	12

### ***7.16.6 Runtime performances***

The following runtime performance has been measured.

*Table 51: Runtime performances of xv\_time\_segments\_mapping function*

Ultra Sparc [ms]
TBD

## 7.17 xv\_gen\_swath

### 7.17.1 Overview

The **xv\_gen\_swath** function generates for the different instrument modes the corresponding instrument swath template file. These template files define the swaths to be used in the segment calculation routines of **explorer\_visibility**.

The **xv\_gen\_swath** function contains for each instrument swath type a swath calculation algorithm. The selection of the algorithm depends on the parameters of the corresponding swath definition found in the instrument swath definition file. The algorithm to be used is deduced from the type of swath, the geometry and other instrument dependent parameters. There is an example of a swath definition file in the Appendix A.

The instrument swath template file, consists of a header which contains the altitude range of the swath. The data block contains for  $n$  (between 50 and 6000, typically 1200) equally spread times along one orbit, the location of the swath, for 1 (for point swath types) or 3 points. These points are located from left to right when looking in the flight direction (e.g. for ENVISAT ASAR: from near-swath, via mid-swath, to far-swath). For a description of the swath configuration see section 7.1.2 and figure 8.

For Earth-fixed swaths, the location is given in longitude and latitude, in degrees, for the orbit with a longitude of ascending node of 0.0 degrees. For Inertial swaths, the location is the direction in inertial space (True of Date) in Right Ascension and Declination, in degrees, for the orbit with a Right Ascension of Ascending Node of 0.0 degrees.

The instrument swath template files are only dependent on:

- The instrument swath definition file
- The requested orbit number
- The orbit definition (`orbit_id`).

### 7.17.2 Calling interface

The calling interface of the **xv\_gen\_swath** CFI function is the following (input parameters are underlined):

```
#include <explorer_visibility.h>
{
    xo_orbit_id orbit_id = {NULL};
    xp_atmos_id atmos_id = {NULL};
    long requested_orbit,
        version_number;
    char *swath_definition_file;
    char swath_file[XD_MAX_STR], *dir_name, *file_class,
        *fh_system;
    long status, ierr[XV_ERR_VECTOR_MAX_LENGTH];
    status = xv_gen_swath (&orbit_id, &atmos_id,
                          &requested_orbit, swath_definition_file,
                          dir_name, swath_file,
                          file_class, &version_number, fh_system,
                          ierr);
}
```

```

/* Or, using the run_id */
long run_id;

status = xv_gen_swath_run (&run_id,
                          &requested_orbit, swath_definition_file,
                          dir_name, swath_file,
                          file_class, &version_number, fh_system,
                          ierr);
}

```

For Fortran programs, the declaration and calling procedure is as follows (input parameters are underlined, note that the C preprocessor must be used because of the presence of the #include statement):

```

#include <explorer_visibility.inc>

INTEGER*4 SAT_ID, REQUESTED_ORBIT
INTEGER*4 VERSION_NUMBER
CHAR*(*) ORBIT_SCENARIO_FILE, SWATH_DEFINITION_FILE
CHAR* DIR_NAME, FILE_CLASS, FH_SYSTEM
CHAR*XD_MAX_STR SWATH_FILE
INTEGER*4 STATUS, IERR(XV_ERR_VECTOR_MAX_LENGTH)

STATUS = XV_GEN_SWATH( SAT_ID, ORBIT_SCENARIO_FILE,
& REQUESTED_ORBIT, SWATH_DEFINITION_FILE,
& DIR_NAME, SWATH_FILE,
& FILE_CLASS, VERSION_NUMBER, FH_SYSTEM,
& IERR)

```

### 7.17.3 Input parameters

The `xv_gen_swath` CFI function has the following input parameters:

*Table 52: Input parameters of xv\_gen\_swath function*

C name	C type	Array Element	Description (Reference)	Unit (Format)	Allowed Range
orbit_id	xo_orbit_id*	-	Structure that contains the orbit data.	-	-
atmos_id	xp_atmos_id*	-	Structure that contains the atmosphere initialisation. (Needed only if the swath definition file requires atmosphere initialisation).	-	-

Table 52: Input parameters of xv\_gen\_swath function

C name	C type	Array Element	Description (Reference)	Unit (Format)	Allowed Range
requested_orbit	long*	-	Orbit for which the instrument swath template file will be calculated.	absolute orbit number	> 0
swath_definition_file	char*	-	File name of the instrument swath definition file	-	-
dir_name	char*	-	Directory where the resulting STF is written (if empty (i.e. ""), the current directory is used)	-	-
swath_file	char*	-	Name for output swath file. <u>If empty</u> (i.e. ""), the software will generate the name according to file name specification presented in [FORMATS], in this case the generated name is returned in this variable	-	-
file_class	char*	-	File class for output swath file	-	-
version_number	long*	-	Version number of output swath file	-	>= 0
fh_system	char*	-	System field of the output swath file fixed header	-	-



### 7.17.4 Output parameters

The output parameters of the `xv_gen_swath` CFI function are:

*Table 53: Output parameters of xv\_gen\_swath function*

C name	C type	Array Element	Description (Reference)	Unit (Format)	Allowed Range
swath_file	char*	-	Name for output swath file. <u>This is only an output parameter when it is empty</u> (i.e. ""; see description of this parameter in table 52)	-	-
ierr[XV_ERR_VECTOR_MAX_LENGTH]	long	all	Status vector	-	-

### 7.17.5 Warnings and errors

Next table lists the possible error messages that can be returned by the **xv\_gen\_swath** CFI function after translating the returned status vector into the equivalent list of error messages by calling the function of the EXPLORER\_VISIBILITY software library **xv\_get\_msg** (see [GEN\_SUM]).

This table also indicates the type of message returned, i.e. either a warning (WARN) or an error (ERR), the cause of such a message and the impact on the performed calculation, mainly on the results vector.

The table is completed by the error code and value. These error codes can be obtained translating the status vector returned by the **xv\_gen\_swath** CFI function by calling the function of the EXPLORER\_VISIBILITY software library **xv\_get\_code** (see [GEN\_SUM]).

*Table 54: Error messages of xv\_gen\_swath function*

Error type	Error message	Cause and impact	Error code	Error No
ERR	Error, wrong orbit Id.	Computation not performed	XV_CFI_GEN_SWATH_ORBIT_INIT_ERR	0
ERR	Wrong requested orbit	Computation not performed	XV_CFI_GEN_SWATH_REQUESTED_ORBIT_ERR	1
ERR	Could not get the creation date	Computation not performed	XV_CFI_GEN_SWATH_CURRENT_TIME_ERR	2
ERR	Error transforming time formats	Computation not performed	XV_CFI_GEN_SWATH_TIME_CONVERSION_ERR	3
ERR	Could not create the filename	Computation not performed	XV_CFI_GEN_SWATH_CREATE_FILENAME_ERR	4
ERR	Error computing the swath points	Computation not performed	XV_CFI_GEN_SWATH_XV_ALGOR_ERR	5
ERR	Could not write the swath template file to disk	Computation not performed	XV_CFI_GEN_SWATH_WRITE_ERR	6

### 7.17.6 Runtime performances

The following runtime performance has been measured.

*Table 55: Runtime performances of xv\_gen\_swath function*

Ultra Sparc [ms]
TBD

### 7.17.7 Executable Program

The **gen\_swath** executable program can be called from a Unix shell as:

```
gen_swath -sat satellite_name
          -sdf swath_definition_file_name
          -file orbit_file_name -orbit orbit_number
          [-dir dir_name] (current directory by default)
          [-stf swath_template_filename] (empty string by default)
          [-flcl file_class] (empty string by default)
          [-vers version] (version=0 by default)
          [-fhsys fh_system] (empty string by default)
          [ -v ]
          [ -xl_v ]
          [ -xo_v ]
          [ -xp_v ]
          [ -xv_v ]
          [ -help ]
          [ -show ]
          {(-tai TAI_time -gps GPS_time -utc UTC_time -ut1 UT1_time) |
          (-tmod time_model -tfile time_reference_data file -trid time_reference
          {(-tm0 time 0 -tm1 time 1) | (-orb0 orbit 0 -orb1 orbit 1) } )}
```

Note that:

- Order of parameters does not matter.
- Bracketed parameters are not mandatory (For example, if **-stf** argument is not provided, `instrument_swath_file_name_suffix` is considered to be an empty string).
- Options between curly brackets and separated by a vertical bar are mutually exclusive (For example, that lines 3 and 4 are mutually exclusive).
- [ **-xl\_v** ] option for EXPLORER\_LIB Verbose mode.
- [ **-xo\_v** ] option for EXPLORER\_ORBIT Verbose mode.
- [ **-xp\_v** ] option for EXPLORER\_POINTING Verbose mode.
- [ **-xv\_v** ] option for EXPLORER\_VISIBILITY Verbose mode.
- [ **-v** ] option for Verbose mode for all libraries (default is Silent).
- [ **-show** ] displays the inputs of the function and the results.
- Possible values for *satellite\_name*: ERS1, ERS2, ENVISAT, METOP1, METOP2, METOP3, CRYOSAT, ADM, GOCE, SMOS.

Example:

```
gen_swath -sat ENVISAT -orbit 2000 -osf ACCEPTANCE_OSF.N1
          -sdf SDF_MERIS.1200pts.N1 -xv_v
          -dir ./gen_swath
```

---

## 8 LIBRARY PRECAUTIONS

The following precautions shall be taken into account when using EXPLORER\_VISIBILITY software library:

- When a message like

EXPLORER\_VISIBILITY >>> ERROR in *xv\_function*: Internal computation error # *n*

or

EXPLORER\_VISIBILITY >>> WARNING in *xv\_function*: Internal computation warning # *n*

appears, run the program in *verbose* mode for a complete description of warnings and errors, and call for maintenance if necessary.

## 9 KNOWN PROBLEMS

The following precautions shall be taken into account when using the CFI software libraries:

*Table 56: Known problems*

CFI library	Problem	Work around solution
Fortran	No fortran version of the library exists	-
xv_gps_vis_time	Functions not available yet	-